

### Contents

Introduction .....	2	12. O-ring Gland Design Information .....	131
1. O-ring Standards.....	3	12.A Gland Design Static Axial .....	138
2. O-ring Sealing Principles.....	4	12.B Gland Design Static Radial .....	140
3. O-ring Applications .....	7	12.C Gland Design Dovetail Grooves .....	142
4. Basic Elastomers.....	9	12.D Gland Design Boss Seals .....	144
5. Designing with Rubber .....	22	12.E Gland Design Dynamic Hydraulic .....	145
6. Compound Selection .....	32	12.F Hydraulic Seals with Back-up Rings .....	147
• Standard compounds.....	35	Standard Teflex O-ring Sizes	
• Vulc-O-Rings compounds.....	36	12.G Gland Design for Encapsulated Teflex O-rings .....	151
• Specials.....	37	12.H Gland Design for PTFE O-rings .....	154
• Viton® compounds .....	39	12.I Grafics for O-ring deformations according to	
• Kalrez® compounds.....	47	din 3771 Teil 5 .....	155
• Encapsulated Teflex compounds.....	60	12.J Gland Design for Kalrez® O-rings .....	157
• Metal C- and O-rings .....	69	13. O-ring Assembling Conditions .....	162
• Data sheets .....	85	14. O-ring Size Chart .....	169
• Water-Steam .....	86	14.A A.S.568A Standard O-ring Sizes .....	170
• Metal detectable .....	86	14.B Metric Standard O-ring Sizes .....	179
• Food - Pharma .....	87	14.C JIS-Sizes .....	198
• Vacuum .....	93	15. Tolerances and Surface Imperfections .....	203
• Contact with plastics .....	94	Surface Modifications	
• High purity - FDA - USP.....	94	16. Vulc-O-ring and O-ring Cord .....	212
• Permeability.....	95	17. O-ring Accessories .....	217
• Explosive decompression.....	96	18. O-ring Kits .....	218
• Mineral oils.....	97	19. Quad-Ring®/X-Ring .....	223
• Fuels.....	99	19.A Gland Design for Quad-Ring®/X-Ring .....	224
• Temperature.....	100	19.B Standard Quad-Ring®/X-Ring Sizes .....	227
• Abrasion.....	101	19.C For rotating Quad-Ring®/X-Ring applications .....	235
• Ozone.....	102	20. Troubleshooting .....	236
• Radiation.....	102	21. Glossary .....	239
• Shielding.....	102	22. On-line tools / Conversion Tables .....	248
• Colours.....	103	23. A. Approvals and Acknowledgements .....	253
• Thermal expansion .....	104	B. Applications and Markets .....	254
• Surfaplast modification .....	105	24. ERIKS' Global Network & Technical Service .....	255
• Bio-Hygienic® .....	108		
7. Specifications.....	111		
8. Qualifications .....	116		
9. Test Procedures .....	117		
10. Control .....	126		
11. Storage .....	127		

### Introduction

ERIKS started the distribution of O-Rings in 1952. From this very modest beginning in Alkmaar (the Netherlands), ERIKS has become a world leader in the production and distribution of O-Rings and elastomeric seals. ERIKS has 2000 collaborators in 50 locations worldwide. We produce and distribute seals, gaskets, rubberproducts, engineering plastics, valves and hoses.

Our focus on new markets and new applications has caused ERIKS to expand in many O-Ring applications from standard industrial to high tech semiconductor-applications.

Our 25 year business relationship with DuPont Performance Elastomers on Viton® and Kalrez® seals, our 16.000 different stock items worldwide, our one-day service production, our highly qualified engineering staff are only a few examples of our goal: to be your partner for high performance seals throughout the world.

ERIKS seals are manufactured in accordance with state of the art production and quality control procedures to satisfy the most demanding quality requirements of any industry. ERIKS inventory policies insure that a wide assortment of seals and fluid sealing products are readily available.

As your value-added partner, ERIKS offers the technical expertise to provide customized solutions to your seal requirements. Because of our tremendous technical experience, special applications are no problem for ERIKS. Whether your requirement is for large quantities of durable molded goods or small quantity engineered prototypes -ERIKS is your total seal source.

ERIKS offers not only a broad range of products but a broad range of services as well. When you need seal solutions ERIKS will be standing by to offer superior technical support, customer service, and inventories to satisfy your seal requirements quickly and properly.

The ERIKS organization is set up to allow direct contact between you and our seal specialists. Please call for additional information on these products or any other seal requirements you may have.

### Responsibility

The information in this catalog is based on years of accumulated experience in seal technology and is intended for the use of individuals having technical expertise in the field of seal design. Gland designs are according the latest developments and can differ slightly from previous issues. Due to the large variety of applications and operating parameters, the user, through his own testing and analysis, is solely responsible for making the final selection of product and assuring that all performance and safety requirements are met. Please contact an ERIKS representative for assistance in making your selection as required. The products, features, specifications, and design information in this catalog are subject to change by ERIKS at any time without notice.

### ERIKS O-ring advantages:

- Quality Plus: an integrated system of Quality Control
- A world-wide network for standard compounds
- A broad range of special compounds
- Quick supply production
- Official Viton® licensee and authorised Kalrez® distributor from Dupont Performance Elastomers
- High purity compounds
- Engineered solutions to problems
- Logistics solutions
- Controlled by independent labs



### 1. O-ring Standards

The O-ring has become the world's most popular and versatile seal due to its simple shape, low space requirements, and its availability in a vast selection of sizes and compounds to meet every industrial requirement.

The ERIKS O-ring manual is intended as a guide to assist in the selection of the best O-ring out of the correct rubber compound in the right application for engineers, purchasers, and other users of O-rings. We hope that you find it both convenient and helpful.

This book contains detailed information concerning elastomeric compounds, installation information, sizing tables, and groove dimensions.

The dimension tables represent standards available from ERIKS inventories.

These O-rings are manufactured in accordance with a variety of standards for each country:

- AS 568A            USA
- BS 1806            England
- DIN 3771            Germany
- SMS 1586            Sweden
- AFNOR 47501      France
- JIS B2401            Japan
- ISO 3601            International

There are also military material specifications per a "MIL" designation and aerospace material specifications per a "AMS" designation.

Our standard program covers 30.000 sizes in a large variety of rubber compounds for your specific purpose. Technical data and advice are available at any time. Many non-standard sizes are available upon request.

Please contact your ERIKS representative.

Our qualified staff guarantees excellent service. It's our goal to be your partner.

### 2. O-ring Sealing Principles

O-rings are bi-directional seals, circular in shape and cross section. O-rings are generally made of an elastomeric material, but may be made of other materials such as PTFE or metal. This handbook deals entirely with elastomeric O-rings and PTFE encapsulated elastomeric O-rings.

An O-ring seals through the deformation of the seal material by installation and media pressure to close off the gap between mating components.

Higher system pressures can cause deformation through the gap, known as extrusion, resulting in seal failure. Choosing a harder seal material or installing back-up rings to support the O-ring may alleviate this problem.

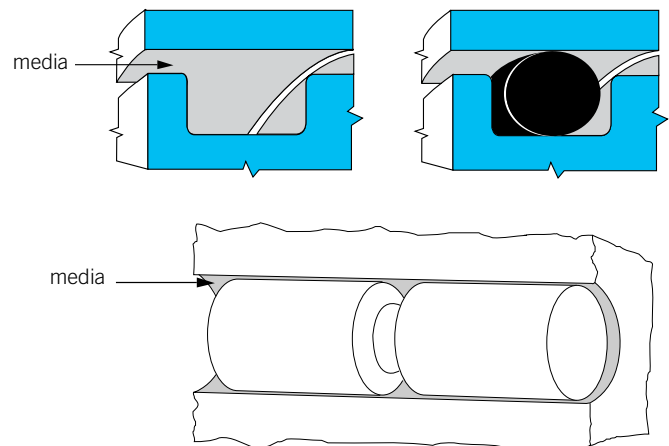

ERIKS O-ring variety of elastomeric compounds .

When you specify an O-ring we need to know the inside diameter (I.D.), the cross section diameter (W), and the compound (elastomer material) from which the O-ring is to be made.

All sealing applications fall into one of two categories - those in which the seal or sealed surface moves, and those in which the seal is stationary.

ID= O-ring inside diameter  
w= O-ring cross section

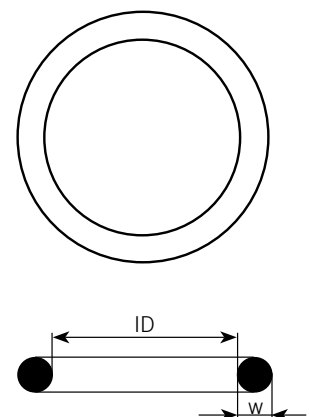

### 2. O-ring Sealing Principles

A seal that does not move, except for pulsation caused by cycle pressure, is called a static seal. Those seals that are subjected to movement are dynamic seals. These are further defined as reciprocating (seals exposed to linear motion) and rotary (stationary seals exposed to a rotating shaft).

O-rings can be successfully used in static as well as dynamic applications. The rubber O-ring should be considered as an incompressible, viscous fluid having a very high surface tension. Whether by mechanical pressure from the surrounding geometry or by pressure transmitted through the hydraulic fluid or gas, this extremely viscous (elastomeric) fluid is forced to flow in the gland to produce zero clearance or a positive block to the flow of the media being sealed. The O-ring absorbs the stack-up of tolerances of the unit and its memory maintains a sealed condition.

Proper seal design begins with the careful consideration of the sealing application. Appropriate material hardness, for example, is determined by the friction and pressure to which the seal will be exposed, as well as the cross sectional dimensions of the seal. Other key factors include temperature range, adjacent surfaces, and media.



Dynamic O-rings may fail by abrasion against the cylinder or piston walls. Therefore, the contacting surfaces should be polished for long seal life. Moving O-rings that pass over ports or other surface irregularities while under pressure are quickly damaged.

In designing an O-ring seal, there are usually several standard cross sectional sizes available. Selecting the best cross section depends on the application. In a reciprocating application, the choice is automatically narrowed because the design tables do not include all the standard O-ring sizes. For any given piston or rod diameter, rings with smaller cross sections tend to twist in the groove while in motion. This leads to leakage and failure. The smaller cross sections for each inside diameter are therefore omitted in the reciprocating design tables. For dynamic applications, the largest cross sectional sizes available should be used to increase stability.

O-rings in reciprocating applications must be radial compressed between the bottom of the seal groove and the cylinder wall for proper sealing action. This compression or squeeze may cause the O-ring to roll slightly in its groove under certain conditions of motion, but the rolling action is not necessary for normal operation of the seal.

The shape of the groove is unimportant as long as it results in proper squeeze of the O-ring.

Groove dimensions are shown in the tables beginning on page 138. The groove depth is measured including the gap.

### 2. O-ring Sealing Principles

The tendency of an O-ring to return to its original shape when the cross section is deflected is the basic reason why O-rings make excellent seals.

The squeeze or rate of compression is a major consideration in O-ring seal design. Elastomers may take up the stack-up of tolerances of the unit and its memory maintains a sealed condition. O-rings with smaller cross sections are squeezed by a higher percentage to overcome the relatively higher groove dimension tolerances.

In static applications the recommended squeeze is usually between 15-30%.

In some cases the very small cross sections can even be squeezed up to 30%.

In vacuum applications the squeeze can even be higher. Squeezing more than 30% induces additional stress which may contribute to early seal deterioration.

In dynamic applications the recommended squeeze is between 8-16%; due to friction and wear considerations, smaller cross sections may be squeezed as much as 20%.

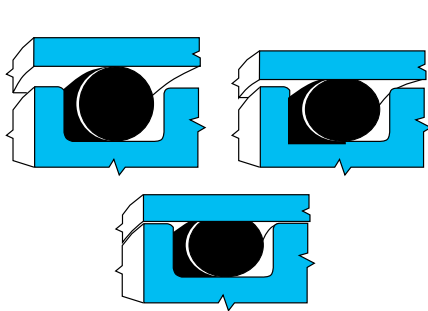

O-ring deformation

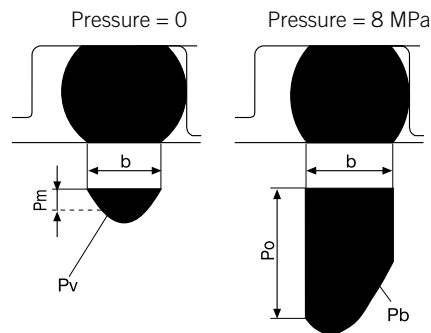

O-Ring Sealing Principle

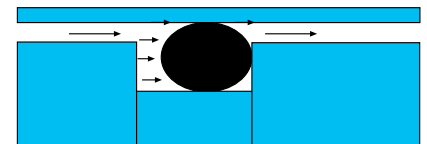

Leakage

(Leakage is possible due to permeability of rubber and roughness of the surface)

### 2. O-ring Sealing Principles

#### Identifying a sealing application type

Although sealing applications can be classified in many different ways. A common method for classifying sealing applications is by the type of motion experienced by the application. The common application types are depicted in the graphic on the right.

#### Sealing tips

- Provide detailed seal installation and assembly instructions, especially if the unit could be serviced by the end-user of the product. When appropriate or required, specify the use of OEM sealing parts.
- Within reason, the larger the cross-section, the more effective the seal.
- Avoid sealing axially and radially at the same time with the same O-ring or Quad-Ring®/X-Ring
- Don't use a seal as a bearing to support a load or center a shaft. This will eventually cause seal failure.

#### Selecting the seal material

When selecting the seal material for the application, carefully consider:

- The primary fluids which the O-ring or Quad-Ring®/X-Ring will seal.
- Other fluids to which the seal will be exposed, such as cleaning fluids or lubricants.
- The suitability of the material for the application's temperature extremes - hot and cold.
- The presence of abrasive external contaminants.
- Lubricating the seal and mating components with an appropriate lubricant before assembling the unit.
- Keeping the seal stationary in its groove - don't let it spin with the rotating member.
- When using back-up rings, increasing the groove width by the maximum thickness of the back-up ring.
- With a face seal, don't try to seal around a square corner. Corners must have a minimum radius of 4 times the seal cross section.

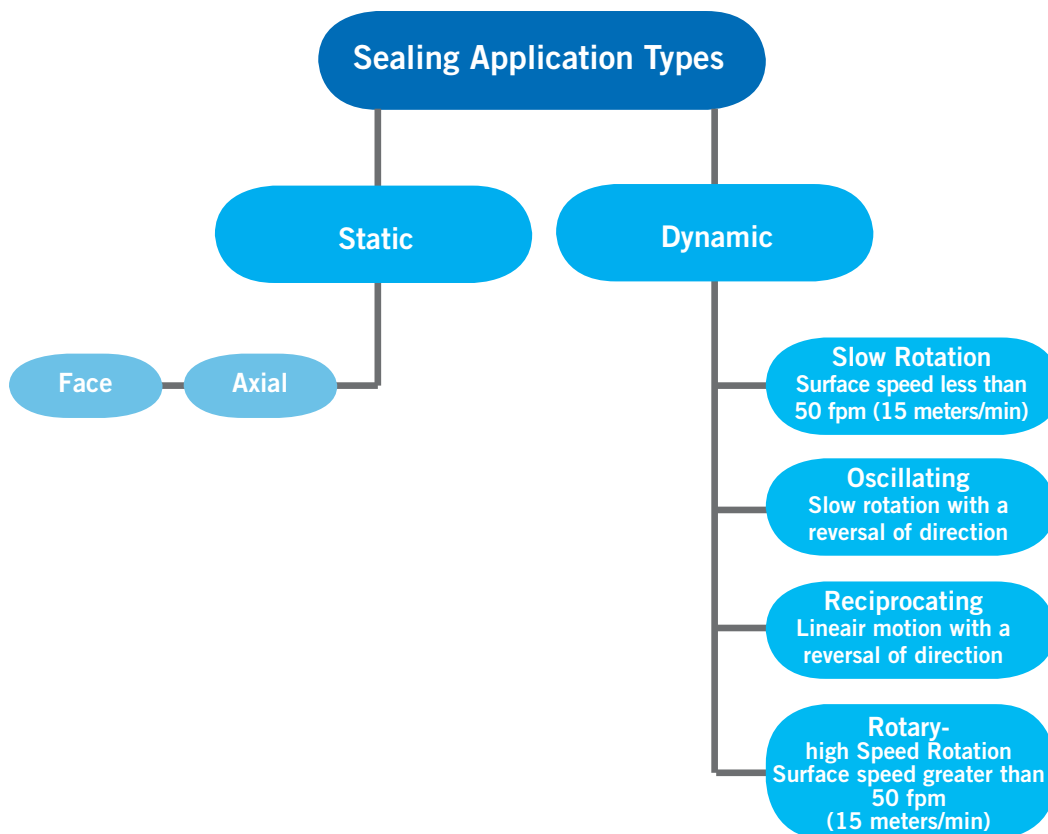

### 3. O-ring Applications

The O-ring is one of the most popular seal choices because:

1. The O-ring is cost effective in purchase price and the cost to machine the seal groove is relatively low.
2. As a bi-directional squeeze seal, the O-ring can be used in an extremely wide variety of successful applications, both static and dynamic.
3. The O-ring material allows for maximum stretch or compression and is therefore quite easy to install, generally requiring no special tools.

#### Static Applications:

There are four varieties of static applications as noted below:

##### 1. Axial

The O-ring cross section is squeezed axially in the groove similar to a flat gasket. See figure 1-10.

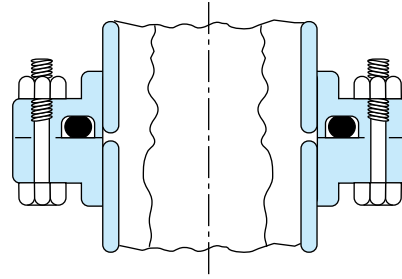

Fig. 1-10

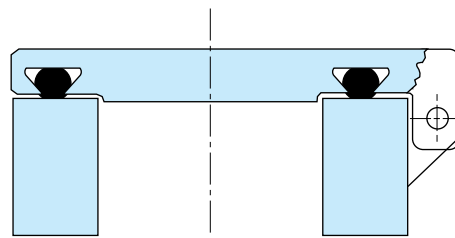

Fig. 1-12

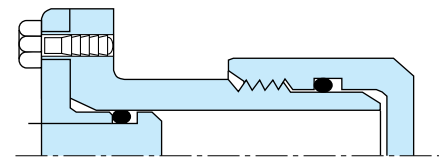

Fig. 1-11

##### 2. Radial

The O-ring cross section is squeezed radially in the groove between the inside (ID) and outside (OD). See figure 1-11.

##### 3. Dovetail

The O-ring is also axially squeezed in a dovetail groove. The groove design allows the O-ring to be retained in the face seal during assembly and maintenance. This is beneficial for special applications where the O-ring has to be fixed by the groove e.g. a lid which opens regularly. See figure 1-12.

##### 4. Boss Seals

The O-ring is used for sealing straight thread tube fittings in a boss. A boss is a cylindrical projection on a casting or forging. The end of that projection is machined to provide a flat, smooth surface for sealing. Straight threads used with an O-ring provide a better seal than tapered threads used alone. See figure 1-13.

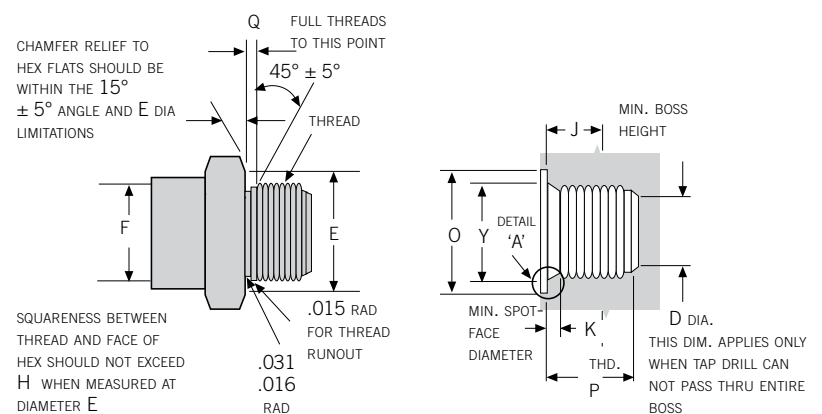

Fig. 1-13

### 3. O-ring Applications

#### Dynamic Applications:

There are three varieties of dynamic applications as noted below:

#### 1. Reciprocating

Reciprocating seals refer to seals used in applications that slide back and forth. This motion introduces friction, which creates design considerations different from those of static seals. The O-ring may be housed in a groove (rod seal) in the cylinder wall instead of a groove in the piston surface (piston seal) without any change in design limitations or seal performance. See figure 1-14.

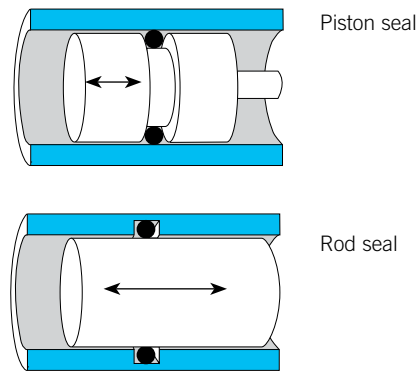

Fig. 1-14

#### 2. Oscillating

Oscillating applications are those seeing both rotary and reciprocating movement. A valve spindle is an example of an oscillating application. See figure 1-15.

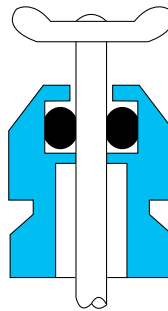

Fig. 1-15

#### 3. Rotary

Rotary seals refer to seals used in applications that rotate. See figure 1-16.

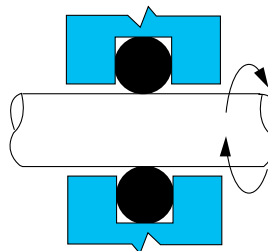

Fig. 1-16

#### Miscellaneous Applications

O-rings are used in a variety of applications. Wipers, buffers, and drive belt applications are just some of the examples. See figure 1-17.

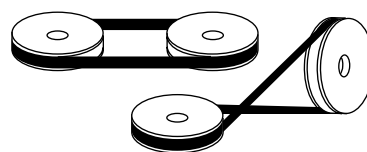

Fig. 1-17 a  
Belt

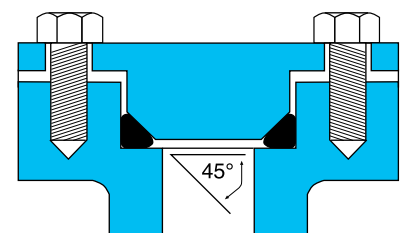

Fig. 1-17 b  
Crush seal application



### 4. Basic Elastomers

#### 4.1. Select the elastomer

Though “elastomer” is synonymous with “rubber”, it is more formally a polymer that can be modified to a state exhibiting little plastic flow and quick or nearly complete recovery from an extending force, and upon immediate release of the stress, will return to approximately its own shape.

According to the definition of the American Society for Testing and Materials (ASTM) for the term “elastomer” it is essential that:

\*An elastomer part must not break when stretched approximately 100%.

\*After being stretched 100%, held for 5 minutes and then released, it must retract to within 10% of its original length within 5 minutes after release.

#### Resistance to the media

As used throughout this manual, the term “media” denotes the substance retained by the o-ring. It may be a liquid, a gas, or a mixture of both. It can even include powders or solids as well. The chemical effect of the media on the O-ring is of prime importance. It must not alter the operational characteristics or reduce the life expectancy of the o-ring. Excessive deterioration of the O-ring must be avoided. It is easy, however, to be misled on this point. A significant amount of volume shrinkage usually results in premature leakage of any O-ring seal, whether static or dynamic. On the other hand, a compound that swells excessively, or develops a large increase or decrease in hardness, tensile strength, or elongation, will often continue to serve well for a long time as a static seal, in spite of undesirable test results on elastomer compounds. The first step in selecting the correct material is to select an elastomer that is compatible with the chemical environment.

#### Compound

A compound is a mixture of base polymer(s) and other chemicals which form a finished rubber material. More precisely, the term ‘compound’ refers to a specific blend of ingredients tailored for particular characteristics required to optimize performance in some specific service.

The basis of compound design is selection of the polymer type. To the elastomer, the compounder may add reinforcing agents, such as carbon black, colored pigments, curing or vulcanizing agents, activators, plasticizers, accelerators, anti-oxidants or anti-radiation additives. There may be hundreds of such combinations.

#### The physics of Rubber

Rubber is composed of long chains of randomly oriented molecules. These long chains are subject to entanglement and cross-linking. The entanglement has a significant impact on the viscoelastic properties such as stress relaxation. When a rubber is exposed to stress or strain energy, internal rearrangements such as rotation and extension of the polymer chains occur. These changes occur as a function of the energy applied, the duration and rate of application, as well as the temperature at which the energy is applied.

ISO 1629 identifies approximately 25 elastomeric types. This chapter covers the various material types used in o-ring manufacture.

#### Relationship of Cross-link Density and Physical Properties

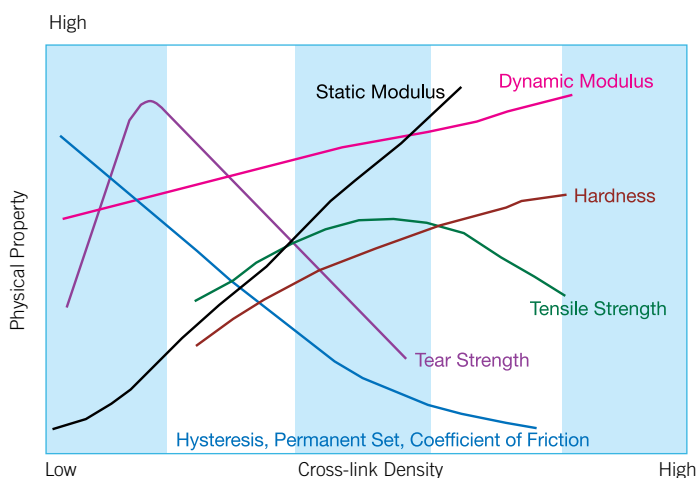

### 4. Basic Elastomers

#### Acrylonitrile butadiene, Nitrile or Buna N (NBR)

Nitrile, chemically, is a copolymer of butadiene and acrylonitrile. Acrylonitrile content varies in commercial products from 18% to 50%. As the nitrile content increases, resistance to petroleum base oils and hydrocarbon fuels increases, but low temperature flexibility decreases.

Due to its excellent resistance to petroleum products, and its ability to be compounded for service over a temperature range of -30°F to +250°F (-35°C to +120°C), nitrile is the most widely used elastomer in the seal industry today. Also many military rubber specifications for fuel and oil resistant O-rings require nitrile based compounds. It should be mentioned that to obtain good resistance to low temperature, it is often necessary to sacrifice some high temperature resistance.

Nitrile compounds are superior to most elastomers with regard to compression set, tear, and abrasion resistance. Nitrile compounds do not possess good resistance to ozone, sunlight, or weather. They should not be stored near electric motors or other ozone generating equipment. They should be kept from direct sunlight. However, this can be improved through compounding.

NBR is the standard material for hydraulics and pneumatics. NBR resists oil-based hydraulic fluids, fats, animal and vegetable oils, flame retardant liquids (HFA, HFB, HFC), grease, water, and air.

Special low-temperature compounds are available for mineral oil-based fluids.

By hydrogenation, carboxylic acid addition, or PVC blending, the nitrile polymer can meet a more specified range of physical or chemical requirements.

The quality of Nitrile-compounds depends on the percentage of acrylonitrile in the base polymer. The following table indicates the change of properties as a function of acrylonitrile content.

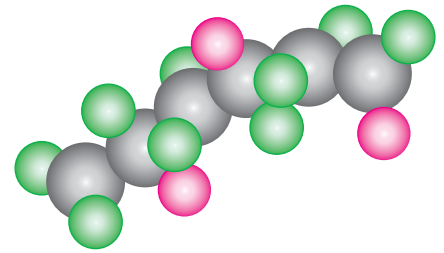
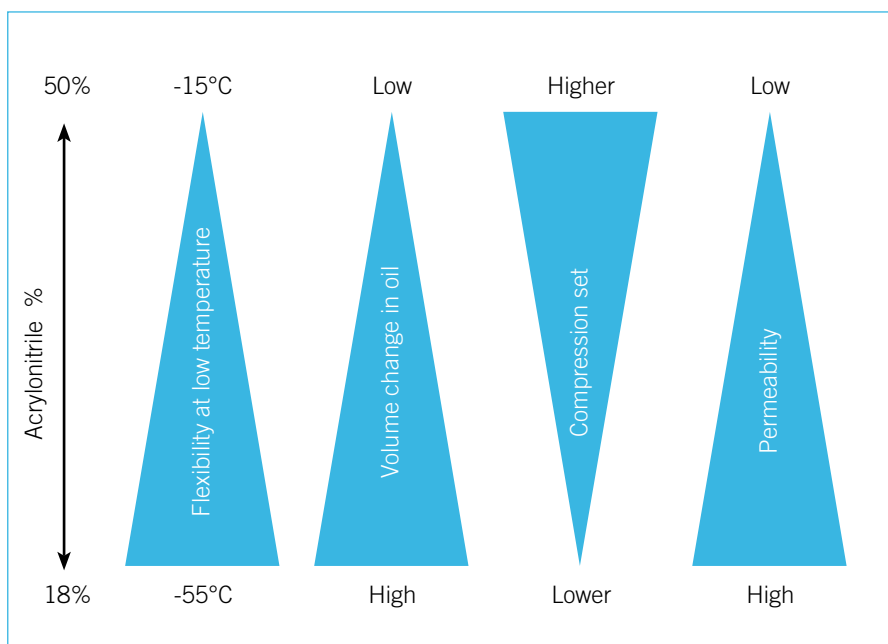

### 4. Basic Elastomers

#### Hydrogenated nitrile, or highly saturated nitrile (HNBR)

HNBR has recently been developed to meet higher temperatures than standard NBR while retaining resistance to petroleum based oils. Obtained by hydrogenating the nitrile copolymer, HNBR fills the gap left between NBR, EPDM and FKM elastomers where high temperature conditions require high tensile strength while maintaining excellent resistance to motor oils, sour gas, amine/oil mixtures, oxidized fuels, and lubricating oils. HNBR is resistant to mineral oil-based hydraulic fluids, animal and vegetable fats, diesel fuel, ozone, sour gas, dilute acids and bases. HNBR also resists new bio-oils (biological oils). HNBR is suitable for high dynamic loads and has a good abrasion resistance. HNBR is suitable for temperatures from  $-30^{\circ}\text{C}$  to  $+150^{\circ}\text{C}$  ( $-20^{\circ}\text{F}$  to  $+302^{\circ}\text{F}$ ).

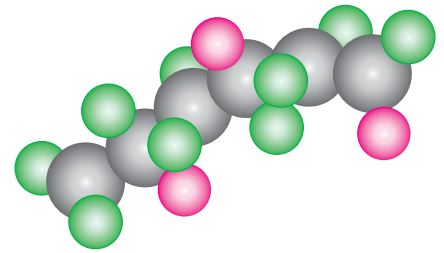

#### Carboxylated nitrile (XNBR)

The carboxyl group is added to significantly improve the abrasion resistance of NBR while retaining excellent oil and solvent resistance. XNBR compounds provide high tensile strength and good physical properties at high temperatures. XNBR is suitable for temperatures from  $-30^{\circ}\text{C}$  to  $+150^{\circ}\text{C}$  ( $-20^{\circ}\text{F}$  to  $+302^{\circ}\text{F}$ ).

#### Nitrile/PVC resin blends (NBR/PVC)

PVC resins are blended with nitrile polymers to provide increased resistance to ozone and abrasion. The PVC also provides a significant improvement in solvent resistance, yet maintains similar chemical and physical properties, commonly noted among nitrile elastomers. The addition of the PVC resins also provide a greater pigment-carrying capacity which allow better retention of pastel and bright colors.

#### Ethylene Propylene, and Ethylene Propylene Diene rubber (EPM, EPDM)

Ethylene propylene rubber is an elastomer prepared from ethylene and propylene monomers (ethylene propylene copolymer) and at times with an amount of a third monomer (ethylene propylene terpolymers). Ethylene propylene rubber has a temperature range of  $-50^{\circ}\text{C}$  to  $+120^{\circ}\text{C}/150^{\circ}\text{C}$  ( $-60^{\circ}\text{F}$  to  $+250^{\circ}\text{F}/300^{\circ}\text{F}$ ), depending on the curing system.

It has a great acceptance in the sealing world because of its excellent resistance to heat, water and steam, alkali, mild acidic and oxygenated solvents, ozone, and sunlight. These compounds also withstand the affect of brake fluids and Skydrol™ and other phosphate ester-based hydraulic fluids. EPDM compounds are not recommended for gasoline, petroleum oil and grease, and hydrocarbon environments. Special EPDM compounds have good resistance to steam.

- EPDM Sulphur cured: inexpensive material for normal use, maximum temperature of  $+120^{\circ}\text{C}$  ( $+250^{\circ}\text{F}$ ).
- EPDM Peroxide cured: for hot water, vapor, alcohols, ketones, engine coolants, organic and inorganic acids and bases. Not resistant to mineral oils. For maximum temperatures of  $+150^{\circ}\text{C}$  ( $+300^{\circ}\text{F}$ ).

### 4. Basic Elastomers

#### Neoprene rubber Polychloroprene (CR)

Neoprene rubbers are homopolymers of chloroprene (chlorobutadiene) and were among the earliest synthetic rubbers used to produce seals. CR has good aging characteristics in ozone and weather environments, along with abrasion and flex cracking resistance. CR is not effective in aromatic and oxygenated solvent environments. Neoprene can be compounded for service temperatures of  $-40^{\circ}\text{C}$  to  $+110^{\circ}\text{C}$  ( $-40^{\circ}\text{F}$  to  $+230^{\circ}\text{F}$ ).

Most elastomers are either resistant to deterioration from exposure to petroleum based lubricants or oxygen. Neoprene is unusual in having limited resistance to both. This, combined with a broad temperature range and moderate cost, accounts for its desirability in many seal applications for refrigerants like Freon® and ammonia. CR is resistant to refrigerants, ammonia, Freon® (R12, R13, R21, R22, R113, R114, R115, R134A), silicone oils, water, ozone, vegetable oils, alcohols, and low-pressure oxygen. CR has a very low resistance to mineral oils.

#### Silicone rubber (VMQ)

Silicones are a group of elastomeric materials made from silicone, oxygen, hydrogen, and carbon. Extreme temperature range and low temperature flexibility are characteristics of silicone compounds. As a group, silicones have poor tensile strength, tear resistance, and abrasion resistance. Special compounds have been developed with exceptional heat and compression set resistance. High strength compounds have also been made, but their strength does not compare to conventional rubber.

Silicones possess excellent resistance to extreme temperatures  $-50^{\circ}\text{C}$  to  $+232^{\circ}\text{C}$  ( $-58^{\circ}\text{F}$  to  $+450^{\circ}\text{F}$ ). Some special compounds resist even higher temperatures. Retention of properties of silicone at high temperature is superior to most other elastic materials. Silicone compounds are very clean and are used in many food and medical applications because they do not impart odor or taste. Silicone compounds are not recommended for dynamic O-ring sealing applications due to relatively low tear strength and high coefficient of friction.

Silicone is resistant to hot air, ozone, UV radiation, engine and transmission oils, animal and vegetable fats and oils, and brake fluids. VMQ also has low resistance to mineral oils. Silicone can be compounded to be electrically resistant, conductive, or flame retardant. Many silicone compounds have a higher than normal mold shrinkage. Therefore production molds for silicone products are often different than molds for nitrile.

#### Fluorosilicone (FVMQ)

Fluorosilicone combines the good high- and low-temperature properties of silicone with limited fuel and oil resistance. Fluorosilicones provide a much wider operational temperature range than Fluorocarbon rubbers. Primary uses of fluorosilicone O-rings are in fuel systems at temperatures up to  $+177^{\circ}\text{C}$  ( $+350^{\circ}\text{F}$ ) and in applications where the dry-heat resistance of silicone O-rings are required.

Fluorosilicone O-rings may also be exposed to petroleum based oils and/or hydro-carbon fuels. In some fuels and oils; however, the high temperature limit in the fluid list is more conservative because fluid temperatures approaching  $200^{\circ}\text{C}$  ( $390^{\circ}\text{F}$ ) may degrade the fluid, producing acids which attack fluorosilicone O-rings. For low temperature applications, fluorosilicone O-rings seal at temperatures as low as  $-73^{\circ}\text{C}$  ( $-100^{\circ}\text{F}$ ).

Due to relatively low tear strength, high friction and limited abrasion resistance of these materials, they are generally recommended for static applications only. Fluorosilicones with high tear strength are also available. Some of these compounds exhibit improved resistance to compression set. Many fluorosilicone compounds have a higher than normal shrinkage rate so production molds for fluorosilicone products are often different from molds for nitrile.

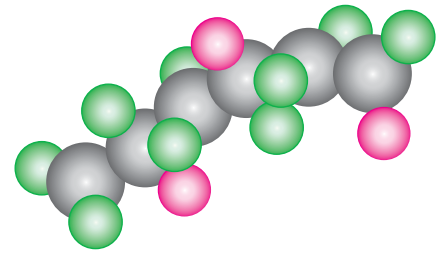

### 4. Basic Elastomers

#### Polyurethane rubber (AU, EU)

Polyurethanes (Polyester-urethane AU), (Polyether-urethane EU) exhibit outstanding mechanical and physical properties in comparison with other elastomers. Urethanes provide outstanding resistance to abrasion and tear and have the highest available tensile strength among all elastomers while providing good elongation characteristics. Ether based urethanes (EU) are directed toward low temperature flexibility applications. The ester based urethanes (AU) provide improved abrasion, heat, and oil swell resistance.

Over a temperature range of  $-40^{\circ}\text{C}$  to  $+82^{\circ}\text{C}$  ( $-40^{\circ}\text{F}$  to  $+180^{\circ}\text{F}$ ), resistance to petroleum based oils, hydrocarbon fuels, oxygen, ozone and weathering is good.

However, polyurethanes quickly deteriorate when exposed to acids, ketones and chlorinated hydrocarbons. Certain types of polyester-urethanes (AU) are also sensitive to water and humidity. Polyether-urethanes (EU) offer better resistance to water and humidity.

The inherent toughness and abrasion resistance of polyurethane (EU) seals is particularly desirable in hydraulic systems where high pressures, shock loads, wide metal tolerances, or abrasive contamination is anticipated.

#### Fluorocarbon rubber (FKM)

Fluorocarbon elastomers have grown to major importance in the seal industry. Due to its wide range of chemical compatibility, temperature range, low compression set, and excellent aging characteristics, fluorocarbon rubber is the most significant single elastomer developed in recent history.

Fluorocarbon elastomers are highly fluorinated carbon-based polymers used in applications to resist harsh chemical and ozone attack. The working temperature range is considered to be  $-26^{\circ}\text{C}$  to  $+205^{\circ}\text{C}$  ( $-15^{\circ}\text{F}$  to  $+400^{\circ}\text{F}$ ). But for short working periods it will take even higher temperatures.

Special compounds having improved chemical resistance are also available with new types always being developed. Generally speaking, with increasing fluorine content, resistance to chemical attack is improved while low temperature characteristics are diminished. There are, however, specialty grade fluorocarbons that can provide high fluorine content with low temperature properties.

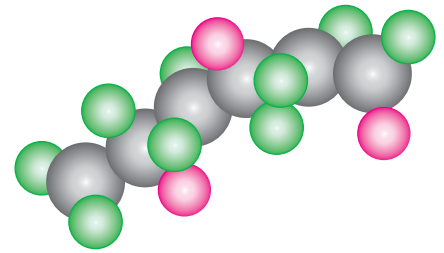

DuPont   
Performance Elastomers



### 4. Basic Elastomers

Fluorocarbon O-rings should be considered for use in aircraft, automobile and other mechanical devices requiring maximum resistance to elevated temperatures and to many fluids. FKM (FPM, Viton®, Fluorel®) resist mineral oils and greases, aliphatic, aromatic and also special chlorinated hydrocarbons, petrol, diesel fuels, silicone oils and greases. It is suitable for high vacuum applications. Many fluorocarbon compounds have a higher than normal mold shrinkage rate, molds for fluorocarbon products are often different from molds for Nitrile.

#### Perfluorocarbons (FFKM)

The relative inertness of fluorocarbon rubbers is provided by fluorine-carbon bonds on the elastomer backbone. Generally speaking, with increasing fluorine content, resistance to chemical attack is improved. Where fluorocarbon rubbers have a fluorine content of 63 - 68 %, the perfluorocarbons have a fluorine content of 73%. Perfluoroelastomers possess excellent resistance to extreme temperatures -26°C to +260°C (-15°F to +500°F). FFKM perfluoroelastomers: (Kalrez®) offers the best chemical resistance of all elastomers.

Some types are particularly suitable for hot water, steam and hot amines. Some resist temperatures up to +326°C (+620°F).

Many perfluorocarbon compounds have unusual mold shrinkage, production molds for perfluorocarbon products are different from molds for nitrile.

#### Teflon®-FEP/PFA

Teflon® FEP/PFA is a copolymer of tetrafluoroethylene and hexafluorpropylene. Teflon® FEP/PFA has a lower melting point than PTFE making it suitable for injection moulding. Teflon® FEP/PFA is used for encapsulation with Teflex O-rings. Teflon® FEP/PFA has a wide spectrum of chemical compatibility and temperature range and excellent aging characteristics. Maximum operating temperature for Teflon® FEP/PFA is +205°C (+400°F). A Teflon® FEP/PFA encapsulation is available for higher temperatures (260°C).

#### TFE/P (Aflas®) (FEPM)

TFE/P is a copolymer of tetrafluoroethylene and propylene with a fluorine content of app. 54%. This material is unique due to its resistance to petroleum products, steam, and phosphate-esters. In some respects it exhibits media compatibility properties similar to ethylene propylene and fluorocarbon. The compression set resistance at high temperatures is inferior to standard fluorocarbons. Service temperatures are -5°C (25°F) to +204°C (+400°F). TFE/P provides improved chemical resistance to a wide spectrum of automotive fluids and additives. It is resistant to engine oils of all types, engine coolants with high level of rust inhibitors, extreme pressure (EP) gear lubricants, transmission and power steering fluids, and all types of brake fluids including DOT 3, mineral oil, and silicone oil.

TFE/P is ideal for heat transfer media, amines, acids and bases, as well as hot water and steam up to +170°C (+340°F).



### 4. Basic Elastomers

#### Polyacrylate rubber (ACM)

Polyacrylate-Acrylic Acid Ester. These compounds are designed to withstand heat while retaining oil resistance. Specially designed for sulfur bearing oil applications, ACMs are subjected to heat and bearing environments. They have good resistance to dry heat, oxygen, sunlight, and ozone but their low temperature properties are relatively poor and they have low swell in mineral oils. Service temperatures are -20°C (-5°F) to 150°C (300°F). ACM is mainly used for O-rings and shaft seals to seal heavy oils at high temperatures and in the automotive industry for transmission and power steering applications.

#### Epichlorohydrin (CO, ECO)

Epichlorohydrin rubber compounds are noted for their superior gas impermeability and physical properties over a wide temperature range while maintaining excellent resistance to petroleum oils. It has a stable cycling capability from low to high temperature. Resistance to ozone, oxidation, weathering, and sunlight are other typical ECO qualities. Service temperatures are -51°C to 150°C (-60°F to +300°F). Compounds from this polymer can exhibit a corrosive nature and can be difficult to process in manufacturing.

#### Vamac®

Ethylene Acrylate. This material exhibits properties similar to polyacrylate but can be formulated to exhibit lower temperature capabilities. It has excellent resistance to oxidation, automatic transmission, and power steering fluids. The temperature service range is -40°C to +150°C (-40°F to +300°F).

#### Styrene Butadiene (SBR, Buna S)

This material is similar to natural rubber. O-ring usage has been on decline since the introduction of ethylene propylene. SBR still finds service in brake fluid applications, although the high temperature range is inferior to that of ethylene propylene compounds. Service range for this material is -50°C to +110°C (-65°F to +225°F).

#### Butyl (IIR)

Butyl has excellent resistance to phosphate ester fluids such as Skydrol™, but has an inferior high temperature limit when compared to ethylene propylene. Butyl exhibits the best resistance to gas permeability and some rocket propellents. For O-ring applications, butyl has been all but replaced by ethylene propylene. The temperature service range for this material is -55°C to +105°C (-65°F to +225°F).

#### Special materials

ERIKS offers many possibilities in special O-rings compounds to improve certain properties like: Silicone free and Labs free Coatings - Encapsulated FEP and PFA - PTFE O-rings - Internal Lubrication - High Purity - Micro O-rings - Vulc-O-rings.

#### Homologations

ERIKS offers many compounds with homologations, like: KTW – FDA – WRC – NSF – DVGW and many more.



#### 4. Basic Elastomers

**Table 3A-1**

Elastomer ASTM	NBR Nitrile	EPDM	CR Neoprene	VMQ Silicone	FVMQ Fluoro silicone	EU Urethane	FKM Fluoro carbon	FFKM Perfluoro carbon	FEP/PFA encapsu- lated
GENERAL									
Hardness (Shore "A")	20/ 90	30/90	15/95	20/90	35/80	60/95	50/95	65/90	-
Temp. range °F/°C max.	230/110	266/130	248/120	446/230	446/230	176/80	410/210	620/326	400/205
Temp. range °F/°C min.	-30/-35	-67/-55	-49/-45	-67/-55	-76/-60	-22/-30	5/-15	-58/504	-76/-605
NOTE : The temperature range is strongly dependent by the specific compound									
Compression Set	B	C	C	A	B	E	C	B	E
Wear Resistance	C	C	C	E	E	A	C	C	E
Gas Permeability	C	C	C	E	E	B	C	C	E
NOTE : The compression set value for Kalrez® is relative to temperature. In low temperature applications this value is reasonable, in high temperatures this value is good to very good.									
Air	E	B	C	A	B	C	B	A	+
Alcohol	B	A	B	B	B	U	E	A	+
Aldehydes	U	B	U	C	U	U	U	Bfi	+
Aliphatic Hydrocarbons	C	U	E	E	A	C	A	A	+
Alkalis	B	A	C	B	B	B	C	A	+
Amines	B1	B1	B1	E1	B1	U	U	Bfi	+
Animal Fats	B	U	C	C	A	C	B	A	+
Aromatic Hydrocarbons	D	U	D	U	B	D	A	A	+
Esters, Alkyl Phosphate (Skydrol)	U	B	U	C	U	U	U	A	+
Esters, Aryl Phosphate	U	A	U	C	B	U	A	A	+
Esters, Silicate	C	U	E	U	B	U	A	A	+
Ethers	U	E	U	U	E	E	U	A	+
Halogenated hydrocarbons	U	U	U	U	B	E	A	A	+
Inorganic Acids	E	C	B	B	B	U	A	A	+
Ketones	U	A	A	C	A	U	U	B	+
Mineral Oil, high analine fats	B	U	C	C	B	A	A	A	+
Mineral Oil, low analine fats	B	U	U	E	B	B	A	A	+
Organic Acids	C	C	C	B	B	U	C	A	+
Silicone Oils	A	A2	A	E	E	A	A	A	+
Vegetable Oils	A	U	C	B	B	E	A	A	+
Water / Steam	C	A	E	E	E	U	B/	C4	+

- |   |                |   |  |
|---|----------------|---|--|
| A | Good           | 1 | See the list "compound selection for chemicals and fluids" |
| B | Satisfactory   | 2 | EPDM may shrink  |
| C | Fair           | 3 | Depending on FKM type                                      |
| D | Doubtful       | 4 | Depending on compound                                      |
| E | Poor           | 5 | Depending on elastomer core                                |
| U | Unsatisfactory | + | in general "A" because the encapsulation is FEP/PFA        |

This information is intended only as a guideline. Chemical compatibility lists should be consulted. ERIKS will provide this on request.

Whenever possible the fluid compatibility of the O-ring compound should be rated "A". For a static seal application a rating "B" is usually acceptable, but it should be tested.

Where a "B" rated compound must be used, do not expect to re-use it after disassembly. It may have swollen enough that it cannot be reassembled.

When a compound rated "C" is to be tried, be sure it is first tested under the full range of operating conditions.

It is also particularly important to test seal compounds under service conditions when a strong acid is to be sealed at elevated temperatures because the rate of degradation of rubber at elevated temperatures is many times greater than the rate of degradation at room temperature.



#### 4. Basic Elastomers

**Chemical and Physical Tables**

Polymer	Tensile Strength (MPa)	Tensile Modulus at 100% (MPa)	Hardness Duro-meter (Shore A)	Elongation (%)	Compression Set Rating	Low Temp Range °F	Low Temp Range °C	High Temp Range °F	High Temp Range °C	Heat Aging at 212° F (100° C)	Steam Resistance	Flame Resistance	Weather Resistance	Sunlight Resistance	Ozone Resistance
NBR	6.9-27.6	2.0-15	20-100	100-650	Good Exc.	-70 to 0	-57 to -18	210 to 250	99 to 121	Good	Fair-Good	Poor	Poor	Poor	Poor
HNBR	31.0-10.0	1.7-20.7	30-95	90-450	Good-Exc.	-50 to 0	-46 to -18	250 to 300	121 to 149	Exc.	Fair-Good	Poor	Good-Exc.	Good-Exc.	Good-Exc.
FKM	3.4-20.7	1.4-13.8	50-95	100-500	Good-Exc.	-50 to 0	-46 to -18	400 to 500	200 to 260	Exc.	Poor-Good	Good-Exc.	Exc.	Good-Exc.	Exc.
EPDM	2.1-24.1	0.7-20.7	30-90	100-700	Poor-Exc.	-75 to -40	-46 to -18	220 to 300	104 to 149	Good-Exc.	Exc.	Poor	Exc.	Exc.	Good-Exc.
SBR	3.4-24.1	2.1-10.3	30-100	450-600	Good-Exc.	-75 to -55	-59 to -48	210 to 250	99 to 121	Good	Fair-Good	Poor	Fair	Poor	Poor
CR	3.4-27.6	0.7-20.7	15-95	100-800	Poor-Good	-70 to -30	-57 to -34	200 to 250	93 to 121	Good-Exc.	Fair-Good	Good-Exc.	Fair-Good	Good-Exc.	Good-Exc.
IIR	13.8-20.7	0.3-3.4	30-80	300-850	Poor-Good	-70 to -400	-57 to -40	250 to 300	121 to 149	Good-Exc.	Good-Exc.	Poor	Exc.	Exc.	Exc.
VMQ, Si, PMQ, PVMQ	1.4-10.3	6.2	20-90	100-900	Good-Good	-178 to -90	-117 to -68	400 to 500	204 to 260	Exc.	Fair-Good	Fair-Exc.	Exc.	Exc.	Exc.
FVMQ	3.4-9.7	3.1-3.4	35-80	100-480	Fair-Good	-112 to -90	-80 to -68	400 to 450	204 to 232	Exc.	Fair	Exc.	Exc.	Exc.	Exc.
ACM	8.6-17.2	0.7-10.3	40-90	100-450	Poor-Good	-30 to 0	-34 to -18	250 to 350	121 to 177	Exc.	Poor	Poor	Exc.	Good-Exc.	Good-Exc.
EA	6.9-20.7	0.7-10.3	35-95	200-650	Poor-Good	-35 to -30	-48 to -34	250 to 350	121 to 177	Exc.	Poor-Fair	Poor	Exc.	Exc.	Exc.
CSM	3-15	0.2-10	40-100	100-700	Poor-Fair	-60 to -40	-51 to -40	225 to 270	107 to 132	Good-Exc.	Poor-Good	Good-Exc.	Exc.	Exc.	Exc.
ECO	10-15	1-10	30-95	200-800	Good-Fair	-60 to -15	-51 to -26	225 to 275	107 to 135	Good-Exc.	Fair-Good	Poor-Good	Good	Good	Good-Exc.
NR; IR	3.4-34.5	0.5-0.8	20-10	300-900	Exc.	-70 to -40	-57 to -40	180 to 220	82 to 104	Fair-Good	Fair-Good	Poor	Poor-Fair	Poor	Poor
AU, EU	6.9-69.0	0.2-34.5	10-100	250-900	Poor-Good	-65 to -40	-54 to -40	180 to 220	82 to 104	Fair-Good	Poor	Poor-Good	Exc.	Good-Exc.	Exc.

#### 4. Basic Elastomers

Chemical and Physical Tables

Polymer	Radiation Resistance	Oxidization Resistance (AIR)	Water Resistance	Gas Permeability Rating	Odor	Taste Retention	Adhesion to Metals	Colorability	RMA Color Code	Resilience or Rebound Rating	Vibration Dampening	Flex Cracking Resistance	Tear Resistance	Abrasion Resistance	Vacuum Weight Loss
NBR	Fair-Good	Good	Good-Exc.	Fair-Exc.	Good	Fair-Good	Exc.	Exc.	Black	Good	Fair-Good	Good	Good-Exc.	Good-Exc.	Good
HNBR	Fair-Good	Exc.	Exc.	Fair-Exc.	Good	Fair-Good	Exc.	Exc.	-	Good	Good-Exc.	Good	Good-Exc.	Good-Exc.	Good
FKM	Fair-Good	Exc.	Exc.	Good-Exc.	Good	Fair-Good	Good-Exc.	Good-Exc.	Brown	Fair-Exc.	Fair-Good	Good	Fair-Good	Good	Exc.
EPDM	Good-Exc.	Exc.	Exc.	Fair-Good	Good	Good-Exc.	Good-Exc.	Good-Exc.	Purple	Fair-Good	Fair-Good	Good	Fair-Good	Good	Exc.
SBR	Poor-Good	Fair-Exc.	Good-Exc.	Fair	Good	Fair-Good	Exc.	Good	-	Fair-Exc.	Fair-Good	Good-Exc.	Fair-Exc.	Good-Exc.	Poor
CR	Fair-Good	Good-Exc.	Fair-Good	Fair-Good	Fair-Good	Fair-Good	Exc.	Fair	Red	Fair-Good	Good-Exc.	Good	Good-Exc.	Good-Exc.	Fair
IIR	Poor-Good	Exc.	Good-Exc.	Good	Good	Fair-Good	Good	Good	-	Poor-Good	Exc.	Good-Exc.	Good	Fair-Good	Exc.
VMQ, Si, PMQ, PVMQ	Poor-Good	Exc.	Exc.	Poor-Fair	Good	Good-Exc.	Good-Exc.	Exc.	Rust	Good-Exc.	Fair-Good	Poor-Good	Poor-Good	Poor-Good	Exc.
FVMQ	Fair-Exc.	Exc.	Exc.	Poor-Good	Good	Good	Good-Exc.	Good-Exc.	Blue	Exc.	Good	Poor-Good	Poor-Exc.	Poor	Exc.
ACM	Poor-Good	Exc.	Poor-Fair	Good-Exc.	Fair-Good	Fair-Good	Good	Good	-	Fair-Good	Good-Exc.	Fair-Good	Poor-Good	Fair-Good	Good
EA	Good	Exc.	Good-Exc.	Exc.	Good	Fair-Good	Good	Good	-	Poor-Fair	Good	Good	Good-Exc.	Good-Exc.	Fair-Good
CSM	Poor-Good	Exc.	Good	Good-Exc.	Good	Fair-Good	Exc.	Exc.	-	Fair-Good	Fair-Good	Fair-Good	Fair-Good	Good-Exc.	Fair
ECO	Poor	Good-Exc.	Good	Exc.	Good	Good	Fair-Good	Good	-	Good	Good	Good	Fair-Exc.	Fair-Good	Good
NR, IR	Fair-Good	Good	Exc.	Fair-Good	Good-Exc.	Fair-Good	Exc.	Poor	-	Exc.	Good-Exc.	Exc.	Good-Exc.	Good-Exc.	Poor
AU, EU	Good-Exc.	Good-Exc.	Poor-Good	Good-Exc.	Exc.	Fair-Good	Exc.	Good-Exc.	-	Poor-Good	Fair-Good	Good-Exc.	Exc.	Exc.	Good

#### 4. Basic Elastomers

**Chemical and Physical Tables**

Polymer	Acids (dilute)	Acids (concentrated)	Acid, organic (dilute)	Acid, organic (concentrated)	Alcohols (C1 thru C4)	Aldehydes (C1 thru C6)	Alkalies (dilute)	Alkalies (concentrated)	Amines	Animal & Vegetable oils	Brake Fluid; Dot 3, 4 & 5	Dlester Oils	Esters, Alkyl Phosphate
NBR	Good	Poor-Fair	Good	Poor	Fair-Good	Poor-Fair	Good	Poor-Good	Poor	Good-Exc.	Poor	Fair-Good	Poor
HNBR	Good	Fair-Good	Good	Fair-Good	Good-Exc.	Fair-Good	Good	Poor-Good	Good	Good-Exc.	Fair	Good	Poor
FKM	Good-Exc.	Good-Exc.	Fair-Good	Poor-Good	Fair-Exc.	Poor	Fair-Good	Poor	Poor	Exc.	Poor-Fair	Good-Exc.	Poor
EPDM	Exc.	Exc.	Exc.	Fair-Good	Good-Exc.	Good-Exc.	Exc.	Exc.	Fair-Good	Good	Good-Exc.	Poor	Exc.
SBR	Fair-Good	Poor-Fair	Good	Poor-Good	Good	Poor-Fair	Fair-Good	Fair-Good	Poor-Good	Poor-Good	Poor-Good	Poor	Poor
CR	Exc.	Poor	Good-Exc.	Poor-Good	Exc.	Poor-Fair	Good	Poor	Poor-Good	Good	Fair	Poor	Poor
IIR	Good-Exc.	Fair-Exc.	Good	Fair-Good	Good-Exc.	Good	Good-Exc.	Good-Exc.	Good	Good-Exc.	Good	Poor-Good	Good
VMQ, Si, PMQ, PVMQ	Fair-Good	Poor-Fair	Good	Fair	Fair-Good	Good	Poor-Fair	Poor-Exc.	Good	Good	Good	Poor-Fair	Good
FVMQ	Exc.	Good	Good	Fair	Fair-Exc.	Poor	Exc.	Good	Poor	Exc.	Poor	Good-Exc.	Poor-Fair
ACM	Fair	Poor-Fair	Poor	Poor	Poor	Poor	Fair	Fair	Poor	Good	Poor	Good	Poor
EA	Good	Poor-Fair	Good-Exc.	Poor-Exc.	Good-Exc.	Fair-Good	Good-Exc.	Poor	Good	Good	Poor	Poor	Poor
CSM	Exc.	Good-Exc.	Exc.	Good	Exc.	Poor-Fair	Good-Exc.	Good-Exc.	Poor	Good	Fair	Poor	Poor
ECO	Good	Poor-Fair	Fair	Poor	Fair-Good	Poor	Fair-Good	Poor-Fair	Poor-Good	Exc.	Poor	Poor-Good	Poor
NR; IR	Fair-Exc.	Poor-Good	Good	Fair-Good	Good-Exc.	Good	Fair-Exc.	Fair-Good	Poor-Fair	Poor-Good	Good	Poor	Poor
AU, EU	Fair-Good	Poor	Fair	Poor	Good	Poor	Poor-Exc.	Poor	Poor-Fair	Fair-Exc.	Poor	Poor-Good	Poor

#### 4. Basic Elastomers

**Chemical and Physical Tables**

Polymer	Esters, Aryl Phosphate	Ethers	Fuel, Aliphatic Hydrocarbon	Fuel, Aromatic Hydrocarbon	Fuel, Extended (Oxygenated)	Halogenated Solvents	Ketones	Lacquer Solvents	L.P. Gases & Fuel Oils	Petroleum Aromatic - Low Aniline	Petroleum Aliphatic - High Aniline	Refrigerant Ammonia	Silicone Oils
NBR	Poor-Fair	Poor	Good-Exc.	Fair-Good	Fair-Good	Poor	Poor	Fair	Exc.	Good-Exc.	Exc.	Good	Good
HNBR	Poor-Fair	Poor-Fair	Exc.	Fair-Good	Good-Exc.	Poor-Fair	Poor	Fair	Exc.	Good-Exc.	Exc.	Good	Good-Exc.
FKM	Exc.	Poor	Exc.	Exc.	Exc.	Good-Exc.	Poor	Poor	Exc.	Exc.	Exc.	Poor	Exc.
EPDM	Exc.	Fair	Poor	Poor	Poor	Poor	Good-Exc.	Poor	Poor	Poor	Poor	Good	Exc.
SBR	Poor	Poor	Poor	Poor	Poor	Poor	Poor-Good	Poor	Poor	Poor	Poor	Good	Poor
CR	Poor-Fair	poor	Poor-Good	Poor-Fair	Fair	Poor	Poor-Fair	Poor	Good	Good	Good	Exc.	Fair-Exc.
IIR	Exc.	Poor-Fair	Poor	Poor	Poor	Poor	Poor-Exc.	Fair-Good	Poor	Poor	Poor	Good	Poor
VMQ, Si, PMQ, PVMQ	Good	Poor	Poor-Fair	Poor	Poor	Poor	Poor	Poor	Fair	Poor	Good	Exc.	Poor-Fair
FVMQ	Good-Exc.	Fair	Exc;	Good-Exc.	Exc.	Good-Exc.	Poor	Poor	Exc.	Good	Good	Exc.	Exc.
ACM	Poor	Poor-Fair	Exc.	Poor-Good	Fair-Good	Poor-Good	Poor	Poor	Good	Fair	Poor	Fair	Exc.
EA	Poor	Poor	Good	Poor-Fair	Fair	Poor-Good	Poor	Poor	Poor	Poor	Poor	Poor-Good	Good-Exc.
CSM	Fair	Poor	Fair-Good	Fair	Fair	Poor	Poor	Poor	Good	Poor	Fair	Good	Exc.
ECO	Poor	Good	Good-Exc.	Good-Exc.	Fair-Good	Poor	Fair	Fair	Exc.	Good-Exc.	Poor	Poor	Good-Exc.
NR, IR	Poor	Poor	Poor	Poor	Poor	Poor	Fair-Good	Poor	Poor	Poor	Poor	Good	Good
AU, EU	Poor	Fair	Good-Exc.	Poor-Fair	Fair-Good	Poor-Good	Poor	Poor	Fair-Good	Good	Good	Poor	Exc.

Note: the chart data provides general elastomer base properties. In many design applications, special compounds are required. ERIKS, therefore, will not be responsible for the usage of this chart in any manner.

#### 4. Basic Elastomers

##### Chemical Terms, Abbreviations, and Trade Names

Chemical Term	ASTM Designated Abbreviation	Polymer Trade Names
Acrylonitrile Butadiene	NBR	Chemigum <sup>®</sup> , Nipol <sup>®</sup> , Krynac <sup>®</sup> , Paracril <sup>®</sup> , Perbunan N <sup>®</sup> , Buna N <sup>®</sup>
Highly Saturated Nitrile	HNBR	Therban <sup>®</sup> , Zetpol <sup>®</sup>
Carboxylated Nitrile	XNBR	Nipol <sup>®</sup> , Krynac <sup>®</sup> , Chemigum <sup>®</sup>
Fluorocarbon	FKM	Viton <sup>®</sup> , Fluorel <sup>®</sup> , Technoflon <sup>®</sup>
Ethylene Propylene	EP, EPDM, EPT, EPR	Nordel <sup>®</sup> , Royalene <sup>®</sup> Vistalon <sup>®</sup> , Buna EP <sup>®</sup> , Keltan <sup>®</sup>
Styrene Butadiene	SBR	Ameripol Synpol <sup>®</sup> , SBR <sup>®</sup> , Plioflex <sup>®</sup> , Stereon <sup>®</sup>
Polychloroprene	CR	Neoprene, Baypren <sup>®</sup> , Butaclor <sup>®</sup>
Isobutylene Isoprene	IIR	Butyl <sup>®</sup>
Silicone	VMQ, PMQ, PVMQ	Silastic <sup>®</sup> , SILPLUS <sup>®</sup> , Elastosil, Wacker <sup>®</sup>
Fluorosilicone	FVMQ	FSE <sup>®</sup> , Silastic <sup>®</sup> , Sylon <sup>®</sup>
Polyacrylate	ACM	Cyanacryl <sup>®</sup> , HyTemp <sup>®</sup> , Thiacril <sup>®</sup>
Ethylene Acrylic	AEM	Vamac <sup>®</sup>
Chlorosulfonated Polyethylene	CSM	Hypalon <sup>®</sup>
Epichlorohydrin	ECO/CO	Gechron <sup>®</sup> , Hydrin <sup>®</sup>
Polyisoprene		
• Natural	NR	SMR <sup>®</sup> , Pale Crepe <sup>®</sup> , Smoked Sheet <sup>®</sup>
• Synthetic	IR	Ameripol SN <sup>®</sup> , Natsyn <sup>®</sup>
Polyurethane (Polyester or Polyether)	AU or EU	Adiprene <sup>®</sup> , Millathane <sup>®</sup> , Vibrathane <sup>®</sup> , Vulkolan <sup>®</sup> , PUR
Perfluoroelastomer	FFKM	Kalrez <sup>®</sup> , Isolast <sup>®</sup> , Chemraz <sup>®</sup> , Simriz <sup>®</sup> , Paraflur <sup>®</sup> , Perlast

The following are registered trademarks of their respective companies:

Cyancryl - American Cyanamid Co.; Ameripol CB, Ameripol SN, Ameripol Synpol - Ameripol Synpol Co.; Butaclor - distigil; Silastic - Dow Corning Corp.; Hypalon, Nordel, Vamac, Viton - DuPont Performance Elastomers; Vistalon - Exxon Chemical Co.; Stereon- Firestone Tire & Rubber Co.; FSE, SILPLUS - General Electric Co.; Budene, Chemigum, Natsyn, Plioflex - Goodyear Rubber Products Corp.; Herclor - Hercules Inc.; Aflas, dyneon, sylon - Dyneon Co.; Hydrin, Hy Temp, Gechron, Nipol, Zetpol - Zeon Chemicals Inc.; Krynac, Taktene, Tornac, Perbunan N, Buna EP, Baypren, Therban - Bayer Corp.; Millathane - TSE Industries, Inc.; Adiprene, Royalene, Paracril, Thiacril, Vibrathane; Uniroyal, Inc.

### 5. Designing with Rubber

In designing an O-ring seal, it is important to determine the O-ring compound early, as the compound selected may have an influence on the gland design. The application determines the rubber compound, the primary factor being the fluid to be sealed. But the elastomer must also resist extrusion when exposed to the maximum anticipated pressure and be capable of maintaining good physical properties through the full temperature range expected.

This chapter discusses the next criteria that must be considered like compression set, hardness, tensile strength, chemical compatibility, thermal effects, pressure, and extrusion. Data and procedures enabling the designer to meet particular requirements or obtain specific performance from the seal will be found in this chapter.

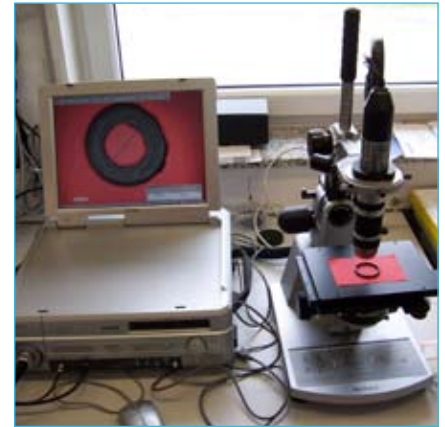

#### Compression Set and Squeeze

Compression set is the percentage of deflection that the elastomer fails to recover after a fixed period of time under a specific squeeze and temperature. Compression set is a very important sealing factor, because it is a measure of the expected loss of resiliency or "memory" of a compound. Compression set is generally determined in air and measured as a percentage of original deflection. Although it is desirable to have a low compression set value, this is not so critical as it might appear because of actual service variables. For instance, an O-ring may continue to seal after taking a 100% compression set, provided the temperature and system pressure remain steady and no motion or force causes a break in the line of seal contact. Also, swelling caused by contact with the service fluid, may compensate for compression set. The condition most to be feared is the combination of high compression set and shrinkage. This will lead to seal failure unless exceptionally high squeeze is employed. Compression set is calculated as follows:

$$C = \frac{t_0 - t_1}{t_0 - t_s} \times 100 \%$$

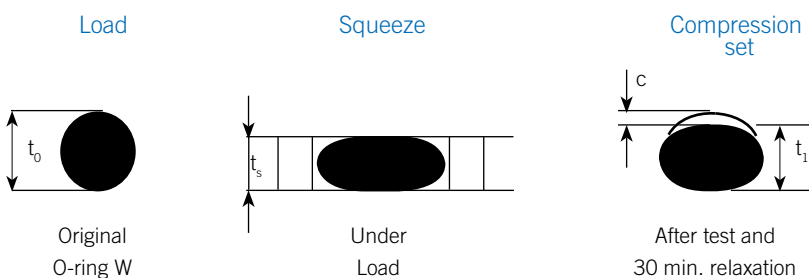

Compression set illustration

### 5. Designing with Rubber

Lower compression set values indicate improved remaining seal capacity. Compression set values generally increase with increased temperature and time.

For O-rings the minimum squeeze should be about .007 inch. (0,175mm). The reason is that with a very light squeeze almost all elastomers quickly take 100% compression set. A good compression set resistant compound can be distinguished from a poor one only when the squeeze is more than .005 inch. (0,127mm)

Most O-ring seal applications cannot tolerate the no squeeze condition, the exceptions are the floating ring designs in special pneumatic and rotary applications.

The most commonly used standards for the expression of compression set are ASTM D 395 and DIN 53517 / ISO 815.

Table 3A-1a gives compression set values for standard Eriks compounds, (Squeeze 25%).

#### Note:

It is important to notice that the compression set changes with time and depends on cross section diameter. This table shows these different values, measured on the same compound.

**Table 3A-1a**

Material	Hardness IRHD ± 5	Compression set 22h/100°C, 25%, on O-ring 3.53 mm.	Temp. Range	
			°C	°F
NBR 36624	70	max. 20%	-30+120	-22+248
NBR 47702	90	max. 30%	-30+120	-22+248
EPDM 55914	70	max. 30%	-50+120	-58+248
EPDM 55914 PC	70	max. 25% (150 °C)	-50+150	-58+302
Silicone 71477	70	max. 40% (200 °C)	-60+220	-76+428
Neoprene 32906	70	max. 25%	-35+110	-31+230
Viton® black 51414	70	max. 18% (200 °C)	-20+200	-4+392
Viton® green 51414	70	max. 19% (200 °C)	-20+200	-4+392
Viton® black 514320	90	max. 18% (200 °C)	-20+200	-4+392

**NBR 36624 O-rings**

Cross section mm	1,78	3,53	6,99
Compression set 22h/100°C (212°F)	14,8	12,8	9,2
Compression set 70h/100°C (212°F)	23,9	22,7	16,8

### 5. Designing with Rubber

#### O-ring Hardness

The hardness of an O-ring is important for several reasons.

The softer the elastomer, the better the seal material conforms to the surfaces to be sealed and lower pressure is required to create a seal. This is particularly important in low pressure seals that are not activated by fluid pressure.

The softer the elastomer, the higher the coefficient of friction. In dynamic applications however, the actual running and breakout friction values of a harder compound with lower coefficients of friction are higher because the load required to squeeze the harder material into the O-ring groove is much greater.

The softer the elastomer the more risk that at high operating pressure the elastomer of the O-ring will extrude into the clearance gap between the mating seal surfaces.

The harder materials offer greater resistance to flow.

With an increase in temperature, elastomers first become softer and then eventually harder as the rubber curing process continues with the application of heat.

The hardness of most elastomers is indicated by a durometer rating on a gauge manufactured by the Shore Instrument Company or equivalent. Most elastomers are measured on the Shore "A" scale. Shore A hardness of 35 is soft; 90 is hard. Shore "D" gauges are recommended where the Shore "A" rating is greater than 90. The most common standards for measuring hardness are ASTM D2240, DIN 53505, BS 2719, and ISO 7619. These standards define a gauge reading on a standard sample with a thickness of 0,25 in. (6 mm.). Always use standard hardness discs 1.28 in. diam. by 0,25 in. thick (ø32 x6 mm.), or 6 in.x 6 in.x 0.075 in. (150x150x2 mm.) sheets piled up to a minimum of 0,25 in. (6 mm.) to determine durometer hardness.

It has been almost impossible to obtain reliable and reproducible hardness readings on seals with curved surfaces and variable cross sections such as O-rings. This problem has plagued the industry for years and is acknowledged in some standard tests. Like ASTM Method D 2240-00, paragraph 6.2.1 states: "A suitable hardness determination cannot be made on an uneven or rough point of contact with the indenter". Also MIL-P-5510B, paragraph 4.4.2. states : "Test specimens for the purpose of batch testing shall consist of one compression molded hardness specimen 0,25 in. thick and 1 in. diameter minimum ( 6 mm. thick and 25 mm. diameter)." The specification states in a note "Hardness shall not be determined from actual packings."

However, for specimens that are too thin or provide too small an area for accurate Shore durometer readings, the Wallace Micro Hardness Tester is the most recommended method. Measurements in Micro-IRHD are more accurate for O-rings. This method of measurement is recorded in the standards ASTM D1415 and DIN 53519. Differences between IRHD and Shore "A" are negligible on the 6 mm thick sample.

Normally, durometer hardness is referred to in increments of five or ten, as in 60 durometer, 70 durometer, 75 durometer, etc. Not as 62, 66, or 72 durometer. This practice is based on the fact that hardness is generally called out in specifications with a tolerance of  $\pm 5$  and also on the inherent variance from batch to batch of a given rubber compound due to slight differences in raw materials and processing techniques and the variability encountered in reading durometers.

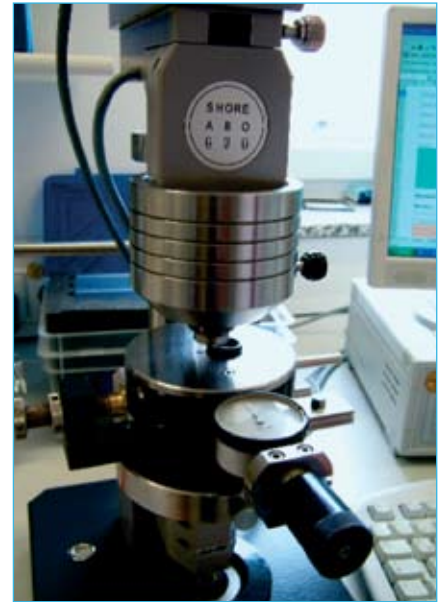



### 5. Designing with Rubber

#### Durometer Ranges Rubber-Plastics

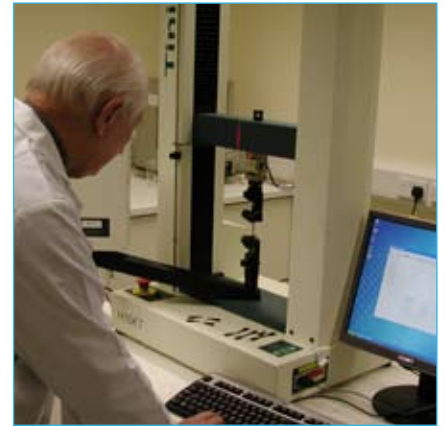
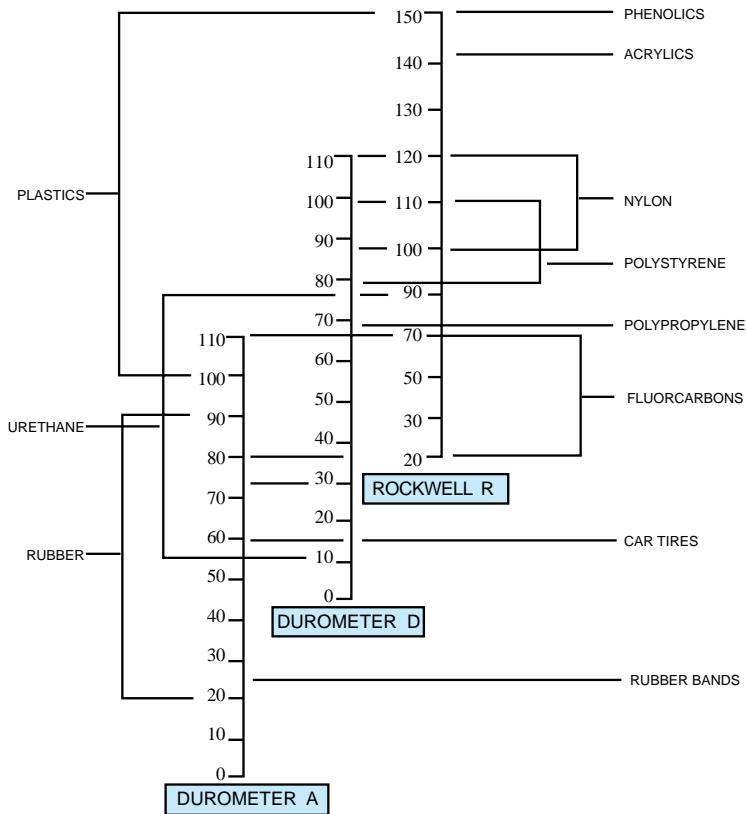

#### IRHD and Shore A



IHRD-Micro  
DIN 53 519 Teil 2  
Norm : 2 mm sheet  
Time : 30 sec.

Shore A DIN 53 505  
Norm : 6 mm sheet  
Time : 3 sec.

### 5. Designing with Rubber

#### Tensile Strength and Elongation

Tensile strength is a measurement of the amount of force required to rupture an elastomeric specimen. Tensile strength is a fair production control measurement used to insure uniformity of the compound, and also useful as an indication of deterioration of the compound after it has been in contact with a fluid for long periods of time. If a large reduction in the tensile strength occurs, the life of a seal may be relatively short. Exceptions to this rule do occur.

Elongation is an increase in length expressed numerically as a percentage of initial length at the point of rupture. This property primarily determines the stretch which can be tolerated during the installation of a seal.

An adverse change in the elongation of a compound after exposure to a fluid is a definite sign of degradation of the material. Elongation, like tensile strength, is used throughout the industry as a check on production batches of compound.

Tests are performed on dumb-bell shaped samples on a machine pulling them apart axially at a constant speed of 500 mm per minute, during which the force and elongation of the sample are recorded.

Standards tests for Tensile strength and Elongation are ASTM D412, DIN 53505, and BS 903, Part A3.



#### Modulus

Modulus, as used by the rubber industry, refers to stress at a predetermined elongation, usually 100%. It gives a comparison for good extrusion resistance. Modulus normally increases with increase in hardness and is probably the best indicator of the strength of a compound, all other factors being equal.

#### Hardness (IRHD) versus Young's Modulus (M)

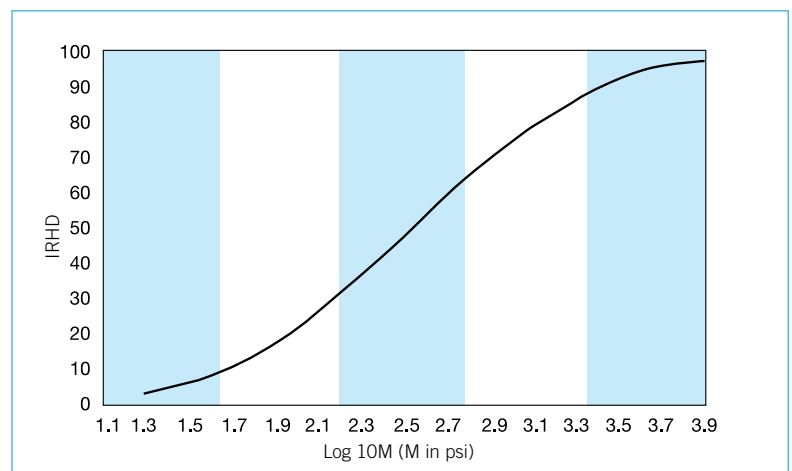

#### Stress versus Strain

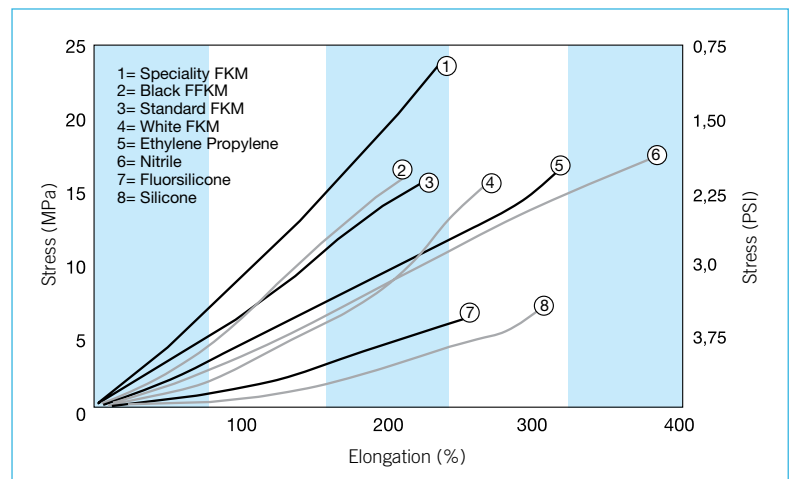

### 5. Designing with Rubber

#### Tensile Stress-Strain

Tensile strength is the maximum tensile stress reached in stretching a test piece (either an O-ring or dumbbell).

Elongation: the strain or ultimate elongation is the amount of stretch at the moment of break.

Modulus: also called 'Mod.100'; this is the stress required to produce a given elongation. In the case of Mod 100, the modulus would be the stress required to elongate the sample 100%.

In elastomers, the stress is not linear with strain. Therefore, the modulus is neither a ratio nor a constant slope - but rather denotes a specific point on the stress-strain curve.

Tensile tests are used for controlling product quality and for determining the effect of chemical or thermal exposure on an elastomer. In the latter case, it is the retention of these physical properties, rather than the absolute values of the tensile stress, elongation or modulus, that is often significant.

#### Tear strength

The tear strength or tear resistance is relatively low for most compounds. This test measures the force to perpetuate a nick or cut. Seal compounds with poor tear resistance will fail quickly under further flexing or stress, once a crack is started. Low tear strength of a compound is also indicative of poor abrasion resistance which may lead to early failure of an O-ring used as a dynamic seal.

#### Volume change

Volume change is the increase or decrease of the volume of an elastomer after it has been in contact with a medium. It is measured as a percentage (%). Increase by swell or decrease by shrinkage in volume is almost always accompanied by a change in hardness.

Volume swell is caused by absorption of gaseous or liquid medium by the O-ring. In static applications, even extreme volume swell can sometimes be tolerated. Actually an O-ring can swell only until 100% gland fill and further increase of volume is not possible, regardless of how much volume swell is observed in a full immersion test. If the free state swell exceeds 50 percent; however, a radially squeeze assembly may be almost impossible to take apart because of the friction generated.

In dynamic applications, volume swell up to 15 or 20 percent is usually acceptable, but higher values are likely to increase friction and reduce toughness and abrasion resistance to the point that use of a particular compound is no longer feasible.

Volume shrinkage is often caused by fluids which extract the plasticizers from the compound. Decrease in volume is usually accompanied by an increase in hardness. Also, as swell compensates for compression set, shrinkage will intensify the compression set effect, causing the O-ring to pull away from sealing surfaces - providing a leakage path. It is apparent then, that shrinkage is far more critical than swell. More than 3 or 4% shrinkage can be a serious problem for dynamic O-ring seals.

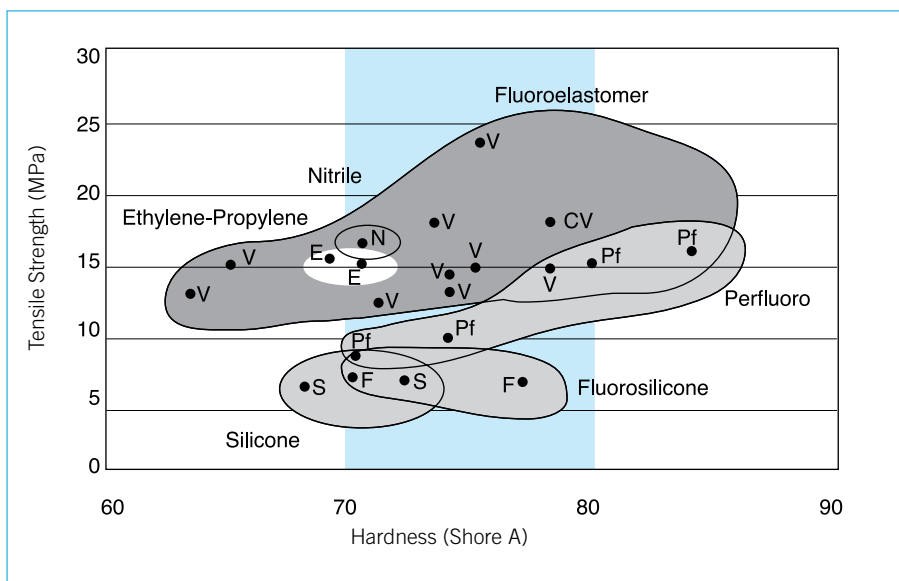

### 5. Designing with Rubber

#### Chemical Compatibility

The chemical guide is intended to assist the user in determining the suitability of various elastomers in many different chemical environments. The ratings are based on a combination of published literature, laboratory tests, actual field experience, and informed judgments. ERIKS uses the DuPont Performance Elastomers guide.

Note: Volume swell is only one indicator of elastomer fluid compatibility and may be based on the solubility parameter alone. Fluid attack on the backbone of the polymer may show up as a change in physical properties such as tensile strength, elongation at break, and hardness.

Elevated temperatures and extended exposure times may create more aggressive conditions.

In some cases, specific elastomer compounds within a material family may provide improved compatibility. Please contact the Application Engineering Department for assistance or consult the Dupont Performance internet chemical resistance guide - where you can find the latest information.

Elastomers can swell and/or degrade in chemical environments through reactions with the polymer backbone and cross-link system, or by reactions with the filler system. In the semiconductor industry, this degradation can be seen in increased contamination and reduced seal life.

Chemical Compatibility Guide Rating System			
Rating	Description	Volume Change	Comments
A	Little or no effect	< 10%	Elastomer may exhibit slight swelling and/or loss of physical properties under severe conditions.
B	Possible loss of physical properties	10-30%	Elastomer may exhibit swelling in addition to a change in physical properties. May be suitable for static applications.
C	Noticeable change	30-50%	Elastomer exhibits a noticeable change in swelling and physical properties. Questionable performance in most applications.
U	Excessive change	> 50%	Elastomer not suitable for service.

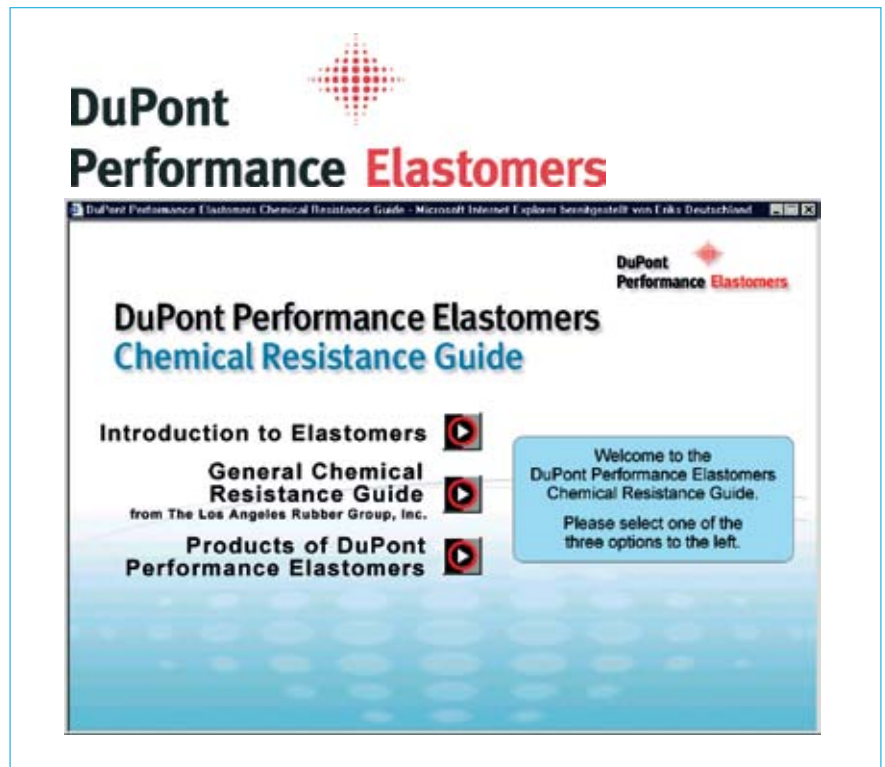

visit our website: [www.o-ring.info](http://www.o-ring.info)

### 5. Designing with Rubber

#### Attack mechanisms: Chemical Compatibility

- The process of chemical degradation or chemical incompatibility is very complex. In general, degradation of the polymer backbone and cross-link may occur by means of:
- nucleophilic attack - nucleophiles are ions or molecules that can donate electrons. This is the main cross-linking mechanism. In certain chemical media, nucleophilic attack can result in increased cross-linking and embrittlement.
- dehydrofluorination - in fluorocarbon elastomers the attack of aliphatic amines can result in the formation of unsaturated bonds in the polymer backbone.
- polar attack - swelling caused by electrostatic interactions between the dipole and polymer chain

Degradation may also occur due to interactions of the chemical environment and elastomer filler systems. This type of degradation may be caused by oxidation of fillers, or by chemical attack of certain fillers or process aids.

In many applications special considerations should be made for contamination or vacuum performance. Contamination is critical in semiconductor fabrication and medical applications. This may take the form of particle generation, extractable ions or other residual gas contamination.

#### Test methods:

ISO 1817 (Liquids)

ASTM D471, D1460, D3137 (Liquids)

#### Volume Swell:

The most common measure of chemical compatibility is volume swell. The following formula is used in reporting volume swell measurements. This takes into account dimensional changes in all three dimensions, and is more precise than specific dimensional change readings for most sealing applications.

#### Volume Swell:

$$VS (\%) = \frac{(\text{Weight in Air-Wt. in Water})_{\text{final}} - (\text{Wt. in Air - Wt. in Water})_{\text{initial}}}{(\text{Weight in Air - Weight in Water})_{\text{initial}}} \times 100$$

#### Note:

The "Weight in Water" measurement is performed by suspending a sample in a container of water and recording its weight. This takes into consideration that the density of a solid is equal to its weight in air divided by the difference of its weight in air and its weight in water.

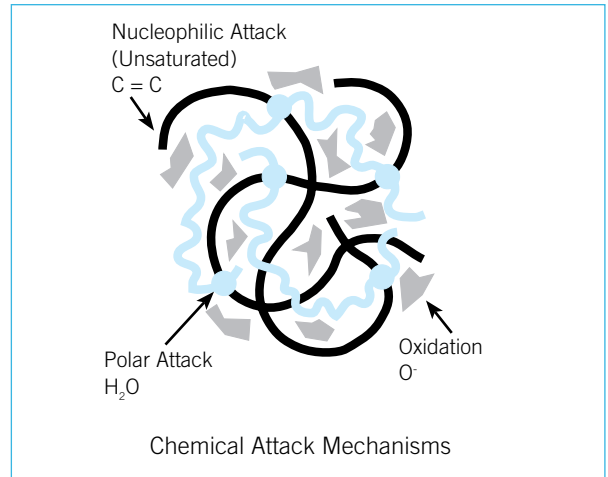

### 5. Designing with Rubber

#### Thermal Effects

All rubber is subjected to deterioration at high temperature. Volume change and compression set are both influenced by heat. Hardness is influenced in a complex way. The first effect of high temperature is to soften the compound. This is a physical change, and will reverse when the temperature drops. In high pressure applications the O-ring may begin to flow through the clearance gap as the temperature rises, due to this softening effect. With increasing time at high temperature, chemical changes occur. These generally cause an increase in hardness, along with volume and compression set changes. Changes in tensile strength and elongation are also involved. Being chemical in nature, these changes are not reversible. The changes induced by low temperature are primarily physical and reversible. An elastomer will almost completely regain its original properties when warmed.

#### Thermal Expansion

Coefficient of linear thermal expansion is the ratio of the change in length per °F or °C to the original length at 0°F or 0°C. Coefficient of volumetric expansion for solids is approximately 3 times the linear coefficient. As a rough approximation, elastomers have a coefficient of thermal expansion 10-times that of steel. With Fluoroelastomers and Perfluoroelastomers the coefficient of thermal expansion is even greater. This can be a critical factor at high temperature if the gland is nearly filled with the O-ring or at low temperature if the squeeze is marginal. Leaking can be the result of seal failure at low temperature if the squeeze is small.

There are certain reactions which in some circumstances cause an O-ring to exert relatively high forces against the sides of the groove. If the seal is completely confined and the gland is 100% filled, the dominating force is the force of thermal expansion of the rubber. The groove must always be sufficiently wide to allow for the maximum expansion of the O-ring. There have been instances where a seal has ruptured a steel gland due to expansion when heated. Therefore it has to be considered that in no case a gland fill in excess of 95% is allowed.

This should be taken into consideration when designing O-ring grooves for applications in excess of 300°F (150°C). Please contact your ERIKS representative for assistance in groove design.

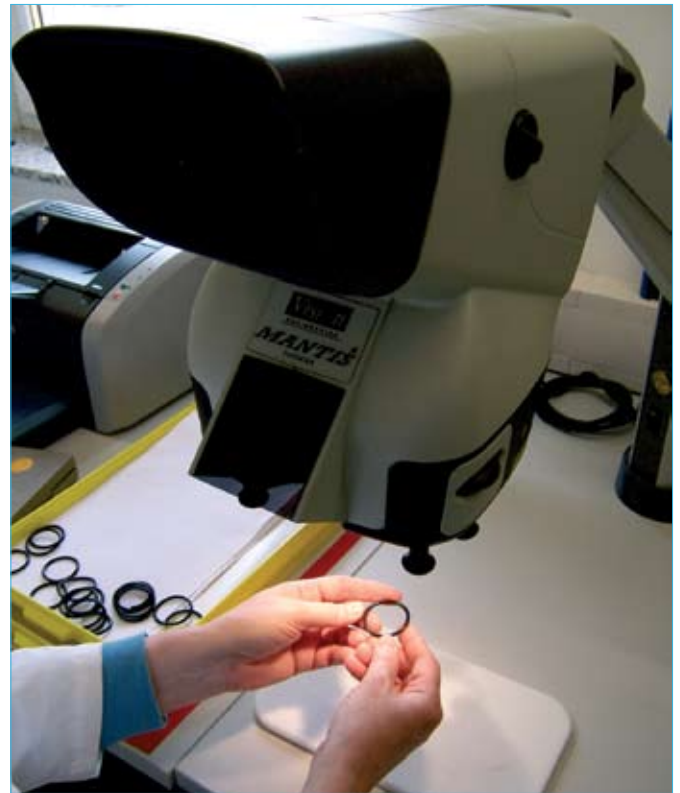

#### Thermal Expansion

Material	Thermal Stability	$\times 10^{-5} / ^\circ\text{C}$
FKM	200°C / 392°F	16
NBR	120°C / 250°F	23
VMQ	230°C / 450°F	59-79
FFKM	300°C / 570°F	23
EPDM	150°C / 300°F	16
Stainless	-	1.04
Aluminium	-	1.3
TEFLON	230°C / 450°F	5-8
KEL-F	280°C / 540°F	4-7
Polyimide	275°C / 530°F	5

### 5. Designing with Rubber

#### Selecting O-ring cross section diameter (CSD)

In general, when selecting O-rings, there are benefits to be gained from having both smaller and larger CSD. Some of the benefits are given below for both cases.

In static applications, where rapid high pressure cycling is not present, it is usually better to choose a larger CSD if possible. As noted above, larger CSD O-rings are less susceptible to the problems of compression set, swell, and incidental surface damage. Also, larger CSD O-rings are more stable and tend not to rotate on assembly. However, if the seal will be subjected to rapid high pressure cycling then it is better to choose a smaller CSD if possible. The smaller section seals are less susceptible to decompression problems.

In dynamic applications it may be better to choose a smaller O-ring CSD to avoid friction problems. In dynamic applications, the CSD is often governed to a great extent by the surface contact speed, as indicated in Table 2.

For dynamic applications with surface contact speeds less than 2,03 m/s the O-ring CSD is generally not critical. There are also some general rules relating O-ring CSD to O-ring ID as follows:

- If :  $0 < ID \leq 20$  mm      CSD = 1,78 or larger
- If :  $20 < ID \leq 100$  mm    CSD = 2,62 or larger
- If :  $100 < ID \leq 200$  mm    CSD = 3,53 or larger
- If :  $200 < ID \leq 300$  mm    CSD = 5,33 or larger

**Table 1 - Characteristics of CSD choice**

Larger section	Smaller section
More stable	Less stable
More friction	Less friction
Needs more space	Needs less space
Better compression set	Poor compression set
Less swell (%)	Possibly more swell (%)
Worse decompression	Better decompression
Larger tolerances	Closer tolerances
Less sensitive to damage	Sensitive to damage

**Table 2 - CSD and surface contact speed (Dynamic seals)**

O-ring CSD (mm)	Maximum surface contact speed (m/s)
1,78	7,62
2,62	3,04
3,53	2,03

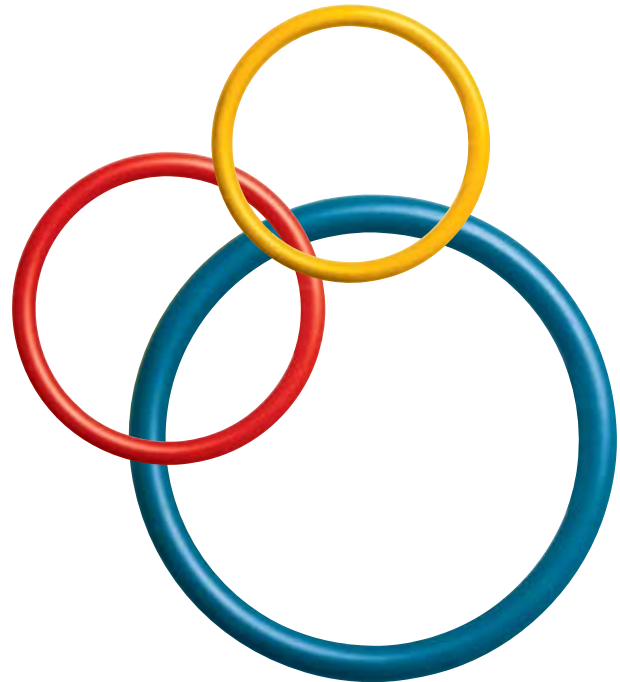

### 6. Compound Selection

#### Operating conditions

The practical selection of a seal compound depends on an adequate definition of the operating conditions.  
In approximate order of application importance/

#### Medium

The first thing to be considered when selecting a seal compound is its resistance to the fluids with which it will come in contact. This means all fluids, including the oil to be sealed, outside air, lubricants, and cleaning agents. For example, in a crankcase, raw gasoline, diesel fuel, gaseous products of combustion, acids formed in service, and water from condensation can be expected to contaminate the engine oil. In this case, the seal compound must be resistant to all fluids including the lubricant to be used on the seal. Therefore, whenever possible, it is a good practice to use the fluid being sealed as the lubricant, eliminating one variable. Consideration must also be given to the effect of the O-ring compound on system fluids. For example:

- There are some ingredients used in compounds which cause chemical deterioration of Freon refrigerants. When choosing a compound for use with Freon, it should not contain any of the ingredients which cause this breakdown.
- Compounds for food and breathing applications should contain only non-toxic ingredients.
- O-rings used in meters or other devices which must be read through glass, a liquid, or plastic, must not discolor these materials and hinder clear vision.

#### Temperature

Temperature ranges are often over specified. Eriks has applied a realistic temperature range with a margin of safety when setting the general operating temperature range for seal compounds.

The maximum temperature recommendation for a compound is based on long term functional service. Since some fluids decompose at a temperature lower than the maximum temperature limit of the elastomer, the temperature limits of both the seal and the fluid must be considered in determining limits for a system.

At low temperature applications a few degrees may sometimes be gained by increasing the squeeze on the O-ring cross section. The low temperature limit on an O-ring seal may be compromised if the O-ring is previously exposed to a fluid that causes the O-ring compound to shrink. Conversely, the limit may be lowered if the fluid causes the O-ring to swell.



### 6. Compound Selection

#### Low Temperature

The low temperature limit is generally 10°C below TR-10 for static seals.

For dynamic seals the TR-10 is more relevant. The TR-10 is the temperature at which an elastomer is able to retract 10%.

Low temperature performance is generally a reversible process.

For design purposes compression is generally increased. The chemical media may cause swelling which may act as a plasticizer and lower the service temperature.

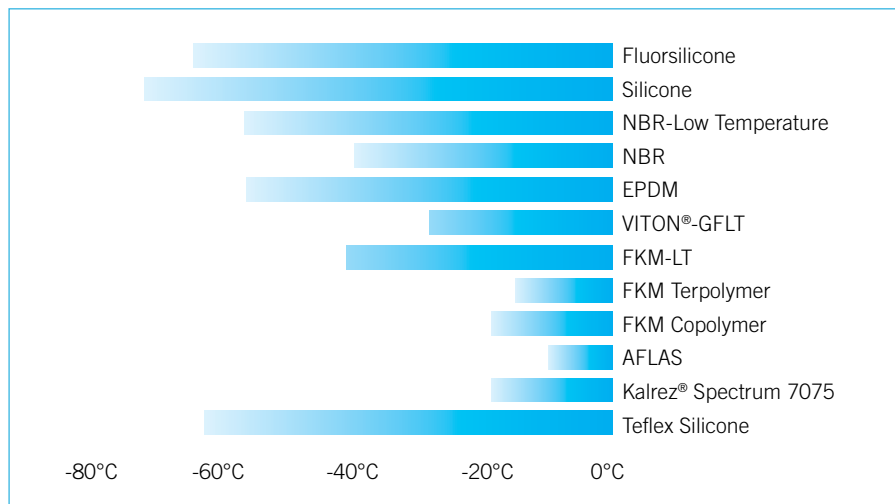

For cryogenic temperature, metal O-rings, see page 69

#### High Temperature

The high-temperature limit is generally considered a 30-50% loss of physical properties and typically represents a maximum temperature for 1,000 hours continuous service. It represents an irreversible change in the backbone or cross-link network. The effect of high temperature can be compounded by the interaction with the chemical media. Chemical reactions typically double with a 10°C increase in temperature.

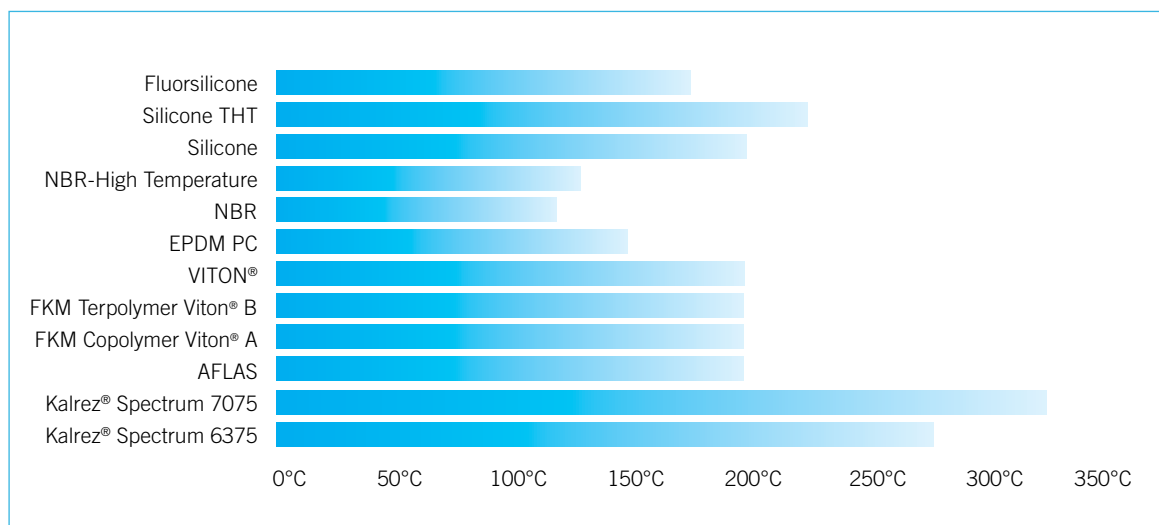

See °F/°C conversion table on page 249.

### 6. Compound Selection

#### Pressure

Pressure has a bearing on seal design as it may affect the choice of compound hardness. At very low pressures proper sealing may be more easily obtained with lower hardness. With high pressures, the combination of pressure and hardness control the maximum clearance that may safely be tolerated. Cyclic fluctuation of pressure can cause local extrusion of the seal, resulting in "nibbling", particularly if the peak pressures are high enough to cause expansion of the cylinder.

#### Time

The three obvious "dimensions" in sealing are, fluid, temperature, and pressure. The fourth dimension, equally important, but easily overlooked, is time. Temperature limits, both high and low, have been published at conventional short term test temperatures. These have little bearing on actual long term service of the seal in either static or dynamic applications.

For example, an industrial nitrile O-ring compound can be recommended to only 120°C (250°F), yet it is known to seal satisfactorily at 149°C (300°F) for 3000 hours and for five minutes at 538°C (1000°F).

Therefore, when the application requires a temperature higher than that recommended in the compound and fluid tables, check the temperature curve to determine if the total accumulated time at high temperature is within the maximum allowable limit.

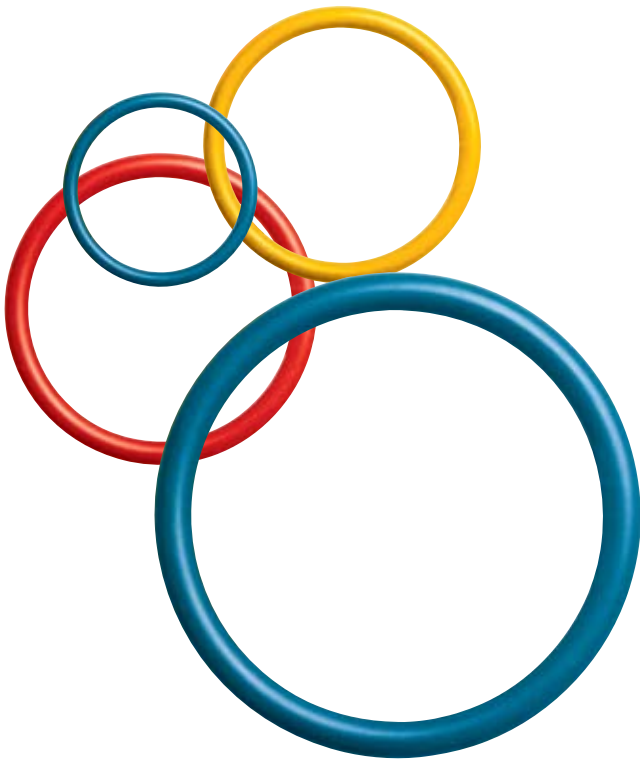

### 6. Compound Selection

We have over 130 different compounds for specific applications. Look at [www.o-ring.info](http://www.o-ring.info)

**TABLE 3A-2 STANDARD ERIKS COMPOUNDS**

Elastomer	Compound Number	Hardness Shore A±5	Temperature °C / °F	Application
Nitrile, NBR, Buna N	36624	70	-35 to +110 °C -31 to +230 °F	Hydraulic Oils, Vegetable Oils, Animal Fats, Acetylene, Alcohols, Water, Air, Fuels and many other products
	47702	90	-25 to +110 °C -13 to +230 °F	Chemical resistance of 36624 with higher hardness for higher pressure applications.
	Various			ERIKS is pleased to offer special compounds for special applications on request.
Ethylene Propylene, EPDM, EPM	55914	70	-55 to +130°C -67 to +266 °F	Solvents, alcohols, ketones, esters, organic and inorganic acids, hydraulic fluids. Highly age resistant. Not recommended for animal fats, vegetable or mineral oils.
	55914PC	70	-50 to +150 °C -58 to +302 °F	Chemical resistance of 55914 with improved temperature range and compression set characteristics. Also for steam applications.
	55918PC	80	-50 to +150 °C -58 to +302 °F	Chemical resistance of 55914 with higher hardness for higher pressure applications.
	Various			ERIKS is pleased to offer special compounds for special applications on request.
Silicone, VMQ	714177	70	-55 to +230 °C -67 to +446 °F	For extremely high or low temperature range, air, oxygen, dry heat, ozone, hot water to 302 °F (150 °C), and glycol based brake fluids. Resistant to hydraulic fluids but is not resistant to many hydraulic fluid additives. Silicones and Fluorosilicones are recommended only for static applications.
Fluorosilicone, FVMQ	614002	70	-50 to +220 °C -58 to +434 °F	Chemical resistance as noted above, with additional resistance to fuels and parafin based lubricants.
	Various			ERIKS is pleased to offer special compounds for special applications on request.
Fluorocarbon, FKM, Vitor®	51414 black and green	70	-20 to +200 °C -4 to +392 °F	Good chemical resistance to oils, fats, fuels. Has very low compression set characteristics at high temperatures. Suitable for vacuum applications.
	514320 black and green	90	-20 to +200 °C -4 to +392 °F	Chemical resistance of 51414 with higher hardness for higher pressure applications.
	Various.			ERIKS is pleased to offer a lot more standard compounds for special applications on request.
Perfluorocarbon, FFKM, Kalrez® Spectrum™	6375	75	-3 to +275 °C +27 to +527 °F	Broadest range of chemical and temperature resistance for chemical processing industry. Suitable for acids, basics, amines amines, steam, ethylene oxide and many other aggressive chemicals.
Kalrez® Spectrum™	7075	75	-4 to +327 °C -25 to +621 °F	High temperature compound with superb compression set characteristics and improved resistance against steam and amines. Very suitable for temperature cycle applications
Kalrez®	4079	75	-2 to +316°C +28 to +600°F	High temperature compound with superb compression set characteristics and poor resistance against steam and amines. Suitable for temperature cycle applications.
FFKM, Kalrez®	Various			ERIKS is pleased to offer special compounds for special applications on request.
Teflex FEP PFA	FKM Core		-20 to +200 °C -4 to +392 °F	High thermal and chemical resistance. Not recommended for dynamic applications. Cannot be stretched in installation.
	VMQ Core		-60 to +200 °C -76 to +392 °F +260°C (PFA)	Chemical resistance of FKM with improved compression set characteristics at low temperatures. Not recommended for vacuum applications due to high gas permeability. Not for dynamic applications.c

## 6. Compound Selection

### STANDARD ERIKS COMPOUNDS (VULC-O-RINGS)

Elastomer	Hardness Shore A ±5	Application
Silicone 75 FDA red 714006, 714206	75	For extremely high or low temperature range, air, oxygen, dry heat, ozone, hot water to 302 °F (150 °C), and glycol based brake fluids. Resistant to hydraulic fluids but is not resistant to many hydraulic fluid additives. Silicones and Fluorosilicones are recommended only for static applications. Food Quality FDA.
Fluorsilicone 75 Blue 614010	75	Solvents, alcohols, ketones, esters, organic and inorganic acids, hydraulic fluids. Highly age resistant. Not recommended for animal fats, vegetable or mineral oils.
EPDM 75 black 559303	75	Solvents, alcohols, ketones, esters, organic and inorganic acids, hydraulic fluids. Highly age resistant. Not recommended for animal fats, vegetable or mineral oils.
EPDM 75 FDA black 559187	75	Solvents, alcohols, ketones, esters, organic and inorganic acids, hydraulic fluids. Highly age resistant. Not recommended for animal fats, vegetable or mineral oils. Food Quality FDA/3A.
NBR 60 black 366304	60	Hydraulic Oils, Vegetable Oils, Animal Fats, Acetylene, Alcohols, Water, Air, Fuels and many other products.
NBR 75 black 366185	75	Hydraulic Oils, Vegetable Oils, Animal Fats, Acetylene, Alcohols, Water, Air, Fuels and many other products.
NBR 90 black 366303	90	Hydraulic Oils, Vegetable Oils, Animal Fats, Acetylene, Alcohols, Water, Air, Fuels and many other products.
HNBR 75 FDA black 886301	75	Better oil and temperature resistance than NBR.
PUR 75 black	75	Abrasion resistance.
AFLAS 75 black 223301	75	Highly steam resistant up to 200°C / 392°F
AFLAS 90 black 223302	90	Highly steam resistant up to 200°C / 392°F
Chloroprene 75 black	75	High ozone resistance.
Chloroprene 75 FDA black	75	High ozone resistance. Food Quality FDA.
Genuine Viton®	65-95	Large product family for different applications. The general-purpose types differ from the specialty types primarily in chemical resistance and low-temperature flexibility. In the speciality family, the choice is among types that are tailored for superior fluid resistance, low-temperature performance, or combinations of these properties. Learn more about the Viton® product family on the following pages.

### 6. Compound Selection - specials

#### For extreme services

Eriks offers a number of compounds for "extreme" services in their application field

- Different NBR, EPDM-compounds for specific applications
- Silicone THT for 280°C resistance
- Fluorosilicone 61370 and 61380 - to MIL-R-25988B
- Aflas® for optimum resistance to steam and crude oils
- HNBR for optimum hydraulic fluid resistance to 150°C - lowest compression set
- And many more...
- Over 250 data sheets are available upon request.

Ask our special edition  
on FDA and USP O-rings !



#### O-rings with homologations

ERIKS has developed a wide range of compounds for contact with food and pharma, drinking water, and gases

#### FDA & ADI

Neoprene 75-compound 329303  
 NBR 60-compound 366312  
 NBR 70-compound 366470  
 NBR 75-compound 366302  
 NBR 70 compound 366472  
 NBR 80 compound 366480  
 NBR 90 compound 366490  
 HNBR 70-compound 866172  
 HNBR 77-compound 886972  
 HNBR 69-compound 866214  
 EPDM 60-compound 559260  
 EPDM 60-compound 559311  
 EPDM 70-compound 55641  
 EPDM 70-compound 559270  
 EPDM 70-compound 559272  
 EPDM 70-compound 559273  
 EPDM 70-compound 55111  
 EPDM 70-compound 559274  
 EPDM 70-compound 559302  
 EPDM 75-compound 559291  
 EPDM 75-compound 559187  
 EPDM 75-compound 559280  
 Genuine Viton® 60-compound 514660  
 Genuine Viton® GLT 70-compound 514115  
 Genuine Viton® 70-compound 514670  
 Genuine Viton® 70-compound 514642  
 Genuine Viton® 70-compound 514672  
 Genuine Viton® 70-compound 514674  
 FKM A 70-compound 514328  
 FKM 75-compound 514010  
 Genuine Viton® A 75-compound 514304  
 Genuine Viton® A 75-compound 514172  
 Genuine Viton® A 75-compound 514641  
 Genuine Viton® 75-compound 514312  
 Genuine Viton® 80-compound 514682  
 Genuine Viton® GFS 75-compound 514683  
 Genuine Viton® 80-compound 514680  
 Teflex-Genuine Viton®  
 Genuine Viton® 90-compound 514690  
 Genuine Viton® 90-compound 514694  
 VMQ Silicone 40 714742  
 VMQ Silicone 40 714747  
 VMQ Silicone 40 714748  
 VMQ Silicone 60 714762

VMQ Silicone 60 714767  
 VMQ Silicone 60 714768  
 VMQ Silicone 60 714217  
 VMQ Silicone 70 714001  
 VMQ Silicone 69 714330  
 VMQ Silicone 70 714002  
 VMQ Silicone 75 714206  
 VMQ Silicone 75 714006  
 VMQ Silicone 80 714782  
 VMQ Silicone 80 714787  
 VMQ Silicone 80 714788  
 Teflex-VMQ Silicone  
 Kalrez® 70 6221  
 Kalrez® 75 6230  
**USP**  
 EPDM 70-compound 559273  
 EPDM 70-compound 559274  
 EPDM 70-compound 559302  
 EPDM 70-compound 559291  
 FKM 75-compound 514010  
 Genuine Viton® 75 514312  
 Teflex Viton®  
 FKM 60-compound 514767  
 FKM 60-compound 514217  
 FKM 70-compound 514001  
 VMQ Silicone 70 714001  
 VMQ Silicone 75 714002  
 Teflex-VMQ Silicone  
 Kalrez® 6221  
 Kalrez® 6230  
**KTW**  
 EPDM 70-compound 55111  
 EPDM 75-compound 559291  
 EPDM 70-compound 559310  
**WRAS**  
 EPDM 70-compound 55111  
 EPDM 75-compound 559291  
 EPDM 70-compound 559310  
**ACS**  
 EPDM 70-compound 55111  
 EPDM 75-compound 559291

**NSF**  
 EPDM 70-compound 55111  
 EPDM 75-compound 559291  
**3A**  
 NBR 60-compound 366312  
 NBR 70-compound 366470  
 NBR 75-compound 366302  
 EPDM 67-compound 559311  
 EPDM 70-compound 559273  
 EPDM 70-compound 559302  
 EPDM 75-compound 559291  
 EPDM 75-compound 559187  
 FKM 70-compound 514328  
 FKM 75-compound 514010  
 Genuine Viton® A 75-comp. 514304  
 Genuine Viton® 75-compound 514172  
 Genuine Viton® 75-compound 514312  
 Silicone 60 714217  
 Silicone 69 714330  
 Silicone 75 714006  
**EN 549**  
 NBR 70-compound 36625  
 NBR 70-compound 366300  
 Genuine Viton® GLT 75-comp. 514102  
**NEN**  
 NBR 70-compound 32770  
**GASTEC**  
 NBR 70-compound 32770  
**DVGW**  
 NBR 70-compound 366300  
 EPDM 70-compound 55111  
 EPDM 70-compound 559310  
 EPDM 75-compound 559291  
 Genuine Viton® GLT 75-comp. 514102  
**KIWA**  
 EPDM 70-compound 55111  
**W-270**  
 EPDM 70-compound 559310  
 EPDM 70-compound 55111  
**BfR**  
 VMQ Silicone 60 714217  
 VMQ Silicone 70 714001  
 VMQ Silicone 75 714002



### 6. Compound Selection - specials

#### O-rings and special applications

- X-rings
- Quad-Rings®/X-Rings
- Micro o-rings
- Vulc-O-rings
- Encapsulated o-rings
- PTFE O-rings
- PTFE back up rings
- NBR 90 back up rings
- Omniseals (with spring) PTFE
- High-purity compounds
- Silicone free
- Labsfree
- Plasma treated
- Coatings with silicone, PTFE, graphite
- With narrow tolerances
- With surface-control
- With homologations
- Internal lubricants (PTFE, graphite, MOS2)
- Eriflon® PTFE hydraulic seals

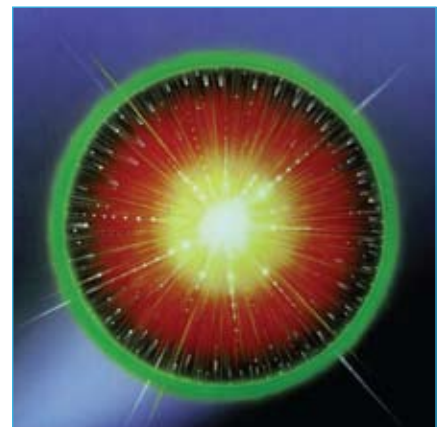
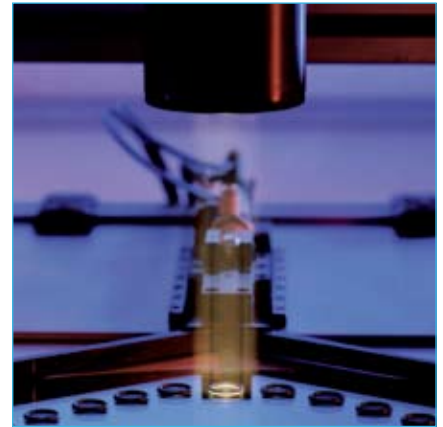

**ERIKS O-rings are made using the latest technology.**

### 6. Compound Selection - Viton®

#### Genuine Viton®

##### 'Only the best is good enough for you'

Today's industry sometimes operates under extreme conditions. Heat, aggressive media, corrosive gasses, and mechanical stress require the utmost performance from seals. Extreme requirements demand quality assurance and the best materials. In many cases Genuine Viton® made by DuPont Performance Elastomers, is the solution. Genuine Viton® is manufactured with 100% pure fluoroelastomers and is certified with the Viton® certificate. ERIKS is appointed a licensed distributor for Genuine Viton® products.

#### How do I make sure that I've got Genuine Viton®?

Only products made of Genuine Viton® carry the specific, easy recognizable label on their package. With parts made of Genuine Viton® one can be assured that the product has been manufactured and processed by both DuPont Performance Elastomers and their licensed partners according to guidelines specified in the Materials Integrity Section of OSHA 1910.119 (Process Safety Management of Highly Hazardous Chemicals Preventive maintenance). Please ask for a copy of ERIKS' Genuine Viton® brochure.

#### The Viton® families

Viton® was introduced in 1958. There are now three major general used families of Viton® fluoroelastomer: A, B, and F. They differ primarily in their resistance to fluids, and in particular aggressive lubricating oils and oxygenated fuels, such as methanol and ethanol automotive fuel blends. There is also a class of high performance Viton® grades: GB, GBL, GF, GLT, GFLT, Extreme, and Base resistant.

Viton® is a registered trademark from DuPont Performance Elastomer.



Relative chemical compatibility and mechanical properties for Viton® fluoroelastomers

Chemical environment	Viton® General use types					Viton® Specialty types		
	A	B	F	GBL-S	GF-S	GLT-S	GFLT-S	ETP-S
Automotive and aviation fuels	1	1	1	1	1	1	1	1
Automotive fuels oxygenated with MEOH, ETOH, MTBE, etc	4	2	1	2	1	4	1	1
Engine lubricating oil, SE and SF	2	1	1	1	1	1	1	1
Engine lubricating oil, SG and SH	3	2	2	1	1	2	1	1
Aliphatic hydrocarbon process fluids, chemicals	1	1	1	1	1	1	1	1
Aromatic hydrocarbon process fluids, chemicals	2	2	1	1	1	2	1	1
Aqueous fluids, steam, mineral acids	3	2	2	1	1	1	1	1
Strong base, high pH, caustic, aminos	4	4	4	2	2	2	2	1
Low molecular weight carbonyls 100% concentrate (MTBB, MBK, MIBK, etc.)	4	4	4	4	4	4	4	1
<b>Compression set and low temperature performance</b>								
Resistance to compression set	1	2	2	2	2	2	2	2
Low temperature flexibility	2	2	3	2	3	1	1	2

Key: 1 = Excellent 2 = Fair 3 = Poor 4 = Not Recommended

### 6. Compound Selection - Viton®

End-use service differences between Types of Viton®

Standard and Speciality Types	Low Temp. Flexibility TR-10, °C	Compression Set, O-rings 70 h/200°C, %	Fluid Resistance % Volume Increase after 168 h				Base Resistance % loss of elongation at break	
			Toluene at 40°C	Fuel C/MeOH (85/15) at 23°C	Methanol at 23°C	Concentrated H2SO4 at 70°C	33% solution of KOH 336h/40°C	ASTM Ref. Oil 105 500h/150°
AL	-19	20-25	20-25	35-40	85-95	12-15	-50	-80
A	-17	12-17	20-25	35-40	85-95	10-12	-45	-80
BL, GBL-S	-15	25-40	12-15	20-25	25-35	3-5	-25	-65
B	-13	25-30	12-15	18-23	25-35	8-10	-25	-70
ETP-S	-11	45-50	6-8	8-10	1-2	4-6	0	-10
GFLT-S	-24	35-40	8-12	10-15	3-5	3-5	-30	-40
GBLT-S	-26	35-40	12-15	27-32	25-35	3-5	-40	-50
F	-8	30-45	8-12	5-10	3-5	7-9	-50	-55
GF-S	-8	30-45	8-12	5-10	3-5	7-9	-45	-50
TBR-S	+3	45-50	60-65	80-90	-	3-5	-10	-20

#### Viton® A-compounds for general use

ERIKS offers six standard O-ring compounds of which thousands of different sizes are available from stock. Please find the most important technical data for these compounds in Table 3A-2d.



Table 3A-2d Standard Genuine Viton® A compound

Technical data	51414 black	51414 green	514320 black	514670	514690	514206 black
Hardness IRHD ±5 DIN 53519	75	75	90	70	90	75
Tensile strength MPa.min. DIN 53504	13	12	14	16,9	14,8	10,7
Elongation % DIN 53504	170	170	120	261	119	213
Compression set % 24h/200°C						
on slab max. DIN 53517	12	14	14	15	12	7,5
on OR 3,53 mm max.	18	19	18			
Heat aging 70h/200°C						
Hardness DIN 53508	+4	+5	+5	-2	-1	+3
Low temperature TR-10 / ASTM 1329	-16°C	-16°C	-16°C	1,82	1,84	2,32
Density ASTM 1817	1,85	2,07	1,87	1,82	1,84	2,32
Max. temperature °C	+200	+200	+200	+200	+200	+200
Miscellaneous Information	stock	stock RAL 6011	stock in black, green on demand	FDA, 1 to 5 day production	FDA, 1 to 5 day production	1 to 5 day production, also Vulc-O-Ring



### 6. Compound Selection - Viton®

#### Petrochemical industry

Due to the permeability of O-ring compounds, high pressure gas can enter into the O-ring. There it builds microscopic bubbles between the molecular chains. Upon withdrawal of the pressure, the gas bubbles expand and cause cracks in the seal composition. ERIKS offers compounds based on Viton® A and Viton® B that meet the highest demands in these applications: high pressures, high temperatures, extrusion resistant, and explosive decompression resistant, for use in contact with natural gas, steam, and corrosion inhibitors, etc.

Obviously, for less critical applications our standard Viton® compounds are also perfectly suitable.

#### Food industry

ERIKS offers a number of compounds with approval for contact with food stuffs. These compounds meet the demands of the Code of Federal Regulations, title 21, Chapter 1, Subchapter B, Paragraph 177.2600 for use in contact with unpacked food stuffs.

For seals, two relevant FDA classes exist: Class 2 for contact with liquids and drinks and Class 1 for contact with milk, milk-derived products, and edible oils.

ERIKS standard Viton® FDA O-rings meet Class 1 requirements. ERIKS can offer the following approved O-rings for Class 1 compounds.

Consult our website [www.o-ring.info](http://www.o-ring.info) for our overview of compounds for the food and beverage industry.



These compounds are also animal derived ingredient free. ERIKS can also supply a number of compounds ranging from 60 to 95 IHRD, that also meet Class 2 requirements.

#### Low temperature applications

Fluoroelastomers do not really excel with regard to low temperature resistance. Standard Viton® A compounds are mostly applicable from -20°C (-4°F) on. Special low temperature Viton® compounds are Viton® GLT and GFLT. These compounds are in many applications suitable at low temperatures of -40°C (-40°F – Viton® GLT) and, with better chemical resistance, from approximately -35 to -30°C (-31 to -22°F – Viton® GFLT).



### 6. Compound Selection - Viton®

#### Special compounds

The following compounds can be applied under very specific circumstances. Only the main characteristics are described. More specific details are available upon request.

#### High Purity Compound

This compound offers a unique combination of chemical resistance and very good plasma resistance. Its contaminating substance content is up to 600 times lower than standard Viton®. It loses very little weight during plasma treatment and contains only one tenth of the surface uncleannesses in reactive plasma. Therefore, a typical compound for the semicon industry.

#### Note:

For very specific requirements, ERIKS can develop special Viton® compounds that meet unique demands even better than these compounds described here. Presently ERIKS has about 65 unique compounds that have already been applied successfully all over the world. It goes without saying that these are custom-made items which are usually not available from stock.

#### Vulc-O-rings

Viton® Vulc-O-rings are made out of very homogenous genuine Viton® O-ring cord with a hardness of 75 and 90 Shore A. The O-rings are made endless under a 45° biased angle, by means of a unique production process. The joint undergoes a follow-up treatment and is hardly visible. Every Vulc-O-ring is made according to ISO 3302/ M2F and E1. The O-ring cord has an extremely low compression set, resulting in a lifetime for Vulc-O-rings that exceeds the average for standard Viton® A O-rings.

#### Note:

In the next chapter "Frequently asked questions about Viton®" you will find a comparison table describing lifetime test results. After 3.000 hours at 390°F (200°C), the joint in the Vulc-O-ring showed the same elasticity value (compression set) as the original cord. This leads us to the conclusion that Vulc-O-rings can be considered equivalent to standard O-rings. A copy of the test report is available upon request.



### 6. Compound Selection - Viton®

#### Frequently asked questions about Viton®

##### 1. Does the compound colour affect the quality of the seal?

Our experience is that chemical and temperature resistance do not change. Mechanical properties of black compounds, however, are often much better than those of coloured compounds.

##### 2. Does the type of carbon black affect the quality of a seal?

Definitely! The standard MT990 carbon black filler offers very good results in all respects. Specific carbon black, such as e.g. Austin Black, can strongly improve the sealing properties. Our compound 514075 brown is made with Austin Black and shows the lowest values in all compression set tests. Other carbon blacks offer the advantage of higher tensile strength or wear resistance.

##### 3. How fast can you supply odd-size O-rings?

Through our unique vulcanisation process, ERIKS can supply any Vulc-O-ring within 48 hours, if required. Standard delivery time for odd-sizes is 1 to 2 weeks.

##### 4. What is post-curing?

After moulding, Viton® parts have to be post-cured at 200°C / 392°F for 8 to 24 hours, depending on the compound. Post-curing optimizes the vulcanisation, causing all links in the molecular structure to develop. The method of post-curing can strongly affect the final quality of the compound.

##### 5. Is there a difference in life among the various compounds?

ERIKS has subjected some of our compounds to life tests. The compression set was measured in air at 200°C / 392°F for 1.000 hours. One may assume that an O-ring has lost its sealing properties after the compression set has reached 100%. The following table gives an overview of four different compounds:

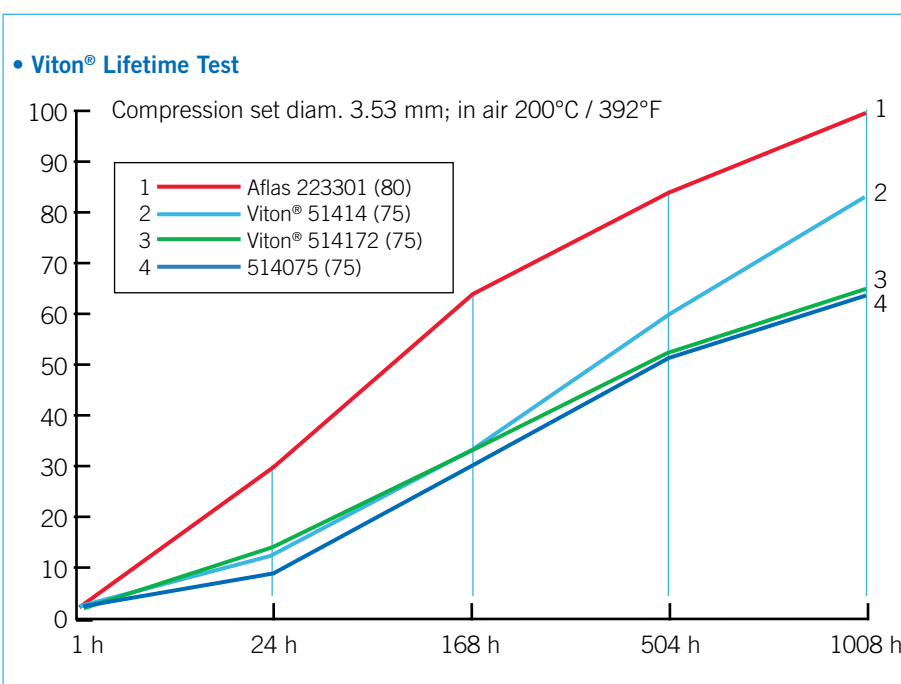
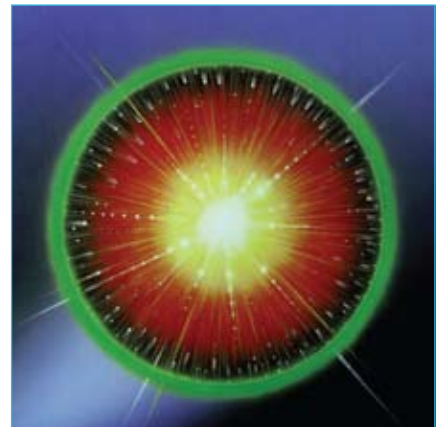

### 6. Compound Selection - Viton®

#### Frequently asked questions about Viton®

##### 6. What is the price difference among these various compounds?

It is difficult to give an exact answer because prices highly depend on size and production quantities. As a guideline, one may use the following chart:

Compound	Price Factor
Viton® A - standard	1
Viton® B	5
Viton® GF	10
Viton® Extreme ETP	50



##### 7. How does media temperature affect the life of a Viton® seal?

The life of a seal is strongly affected by media temperature. ERIKS has measured the time after which the elongation at break is reduced to 50%, at different media temperatures. Following are the results, these are only applicable to Genuine Viton® compounds.

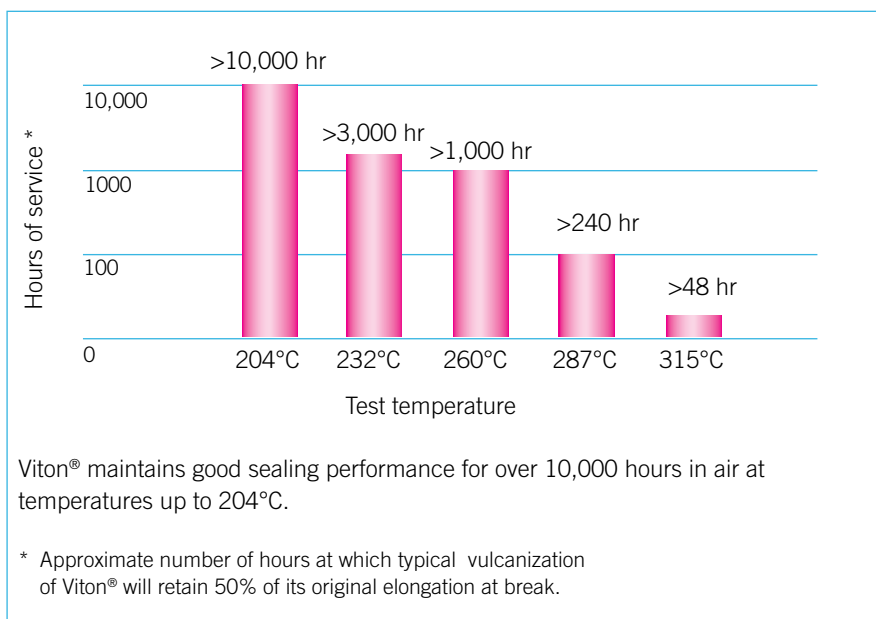

##### 8. How do I learn about the chemical resistance of a Viton® seal?

ERIKS will gladly send out an updated chemical resistance list, upon request. A summarized list is included in this brochure. Since ERIKS is in close contact with DuPont Performance Elastomers' laboratory in Geneva and Switzerland, we are always assured of possessing the latest data. In our own test laboratory, we can also organise specific tests with our Viton® compounds in media provided by our customers. Visit the DuPont Performance Elastomers website for the latest details on chemical resistance. [www.dupontelastomers.com/crg](http://www.dupontelastomers.com/crg)

## 6. Compound Selection - Viton®

### Frequently asked questions about Viton®

#### 9. When should I choose Kalrez®?

Kalrez® is a perfluoroelastomer and, as such, offers chemical and temperature resistance of a different grade, compared to Viton®. Please consult the local ERIKS office for more specific information about this “top of the list” problem solver. Following are the results of compression set tests with Viton® and Kalrez®.



Long term sealing force retention at 204°C

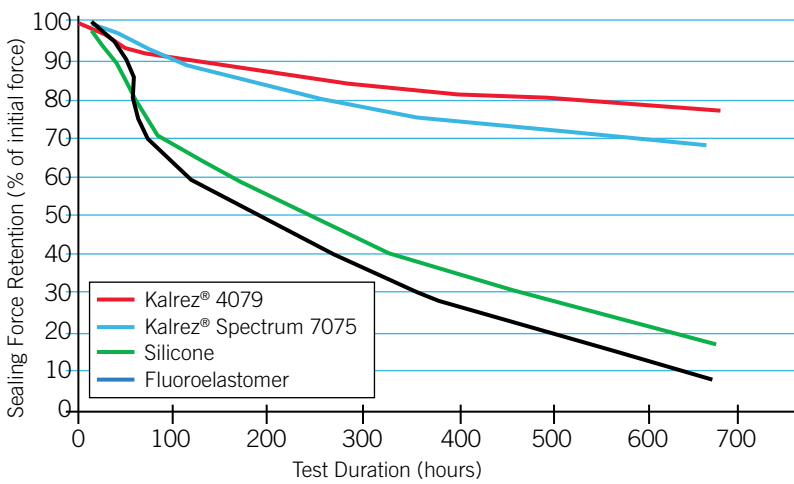

This test proves Kalrez® has a much longer sealing capability than other high temperature elastomers at 204°C/400°F.



## 6. Compound Selection - Viton®



### ERIKS and DuPont Performance Elastomers: Over 25 years of partnership

For 25 years Eriks and DuPont Performance Elastomers have been partners in the production and marketing of original Viton® and Kalrez® High-Tech rubber compounds.

Eriks produces sealing parts made of genuine Viton®. Eriks guarantees quality from the raw material to the end-product, for critical applications that demand the best seals. All information on Viton® fluoroelastomers and Kalrez® perfluoroelastomers can be found in two different Eriks publications, summarizing the various types, compounds, and applications.

The many case studies described in the publications, may offer suggestions for alternative uses for Viton® and Kalrez®.

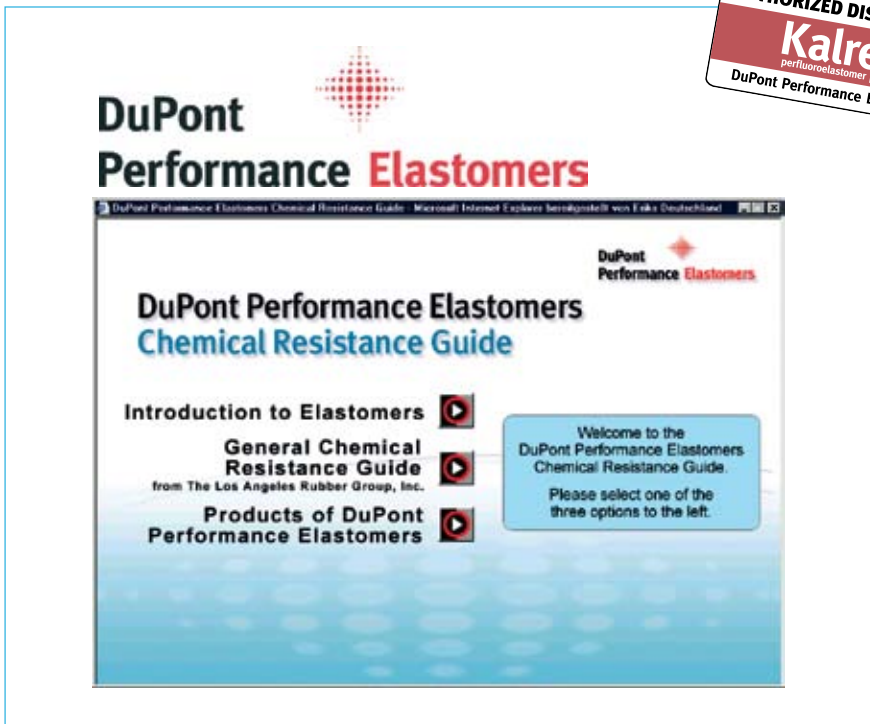

### 6. Compound Selection - Kalrez®

#### Kalrez® for extreme service – engineered for optimum performance

Whenever seals or rubber components are exposed to aggressive chemicals or high temperature, Kalrez® perfluoroelastomer parts outlast the alternatives. Only Kalrez® parts can match the virtually universal chemical resistance and high-temperature stability of PTFE while adding the resilient, no-creep properties of a true rubber.

For over 30 years, DuPont and DuPont Performance Elastomers have been relentless in pursuing improvement in the manufacture of perfluoroelastomer parts. Elastomeric parts typically consist of three components: a polymer chain (the backbone of the elastomer), a crosslinking system (which links the polymer chains together and is the key to elasticity and sealing performance), and a filler system (used to enhance mechanical properties). Based on their extensive experience, DuPont Performance Elastomers adjusts these components to optimize seal performance.

#### Increase safety

Lasting longer and performing better than other elastomers, Kalrez® helps reduce the risk of chemical exposure from seal failure.

#### Increase productivity

By reducing the frequency of seal changes, repairs and inspections, you can increase process and equipment uptime for greater productivity and yield.

#### Reduce maintenance costs

Kalrez® parts help stretch your mean time between repair (MTBR) and lower your maintenance costs. Their durability minimizes unscheduled downtime while letting you extend time between routine inspections and replacement cycles for critical components.

#### Superior chemical resistance to more than 1800 chemicals

Kalrez® perfluoroelastomer parts have virtually universal chemical resistance. They withstand attack from more than 1800 chemicals, solvents and plasmas. Standardizing on Kalrez® products for broad chemical resistance reduces your need to keep multiple materials on the shelf, thus lowering cost of inventory.

#### Service temperature range up to 327°C

Even after long-term exposure to temperatures up to 327°C (620°F), Kalrez® retains its elasticity and recovery properties better than other high-temperature elastomers. Its high-temperature properties, coupled with near universal chemical resistance, enable Kalrez® parts to withstand an extremely broad range of process media.

#### Maintains sealing force to keep seals tight

As proven in ISO 3384 tests, Kalrez® outperforms other elastomers when it comes to sealing force retention, a measure of seal life. Even under harsh and aggressive conditions, Kalrez® will retain its sealing force longer. And thanks to its true-rubber resiliency, Kalrez® prevents leaks caused by creep, a major problem with PTFE.



#### Field Proven

- Over 3 years in Dowtherm\* A at 246°C (475°F)
- Over 24 months in sour gas (9% H<sub>2</sub>S, 15-19% CO<sub>2</sub>) at 149°C (300°F)
- Over 1 month in silicon water nitride process with chlorine and ammonia gas at 218°C (425°F)
- Over 1 year in O-nitrochlorobenzene at 220°C (428°F)
- Over 1 year in maleic anhydride at 169°C (335°F)
- Over 6 months in hot asphalt at 316°C (600°F)
- Over 4 months in 70% acetic acid at 220°C (428°F)
- Over 1 year in dry steam at 250°C (482°F)
- 3 months with lowest ppb ionic extractable levels in wet semiconductor process chemicals at 100°C (214°F)
- Over 17 months in hydrocarbons at 288°C (550°F)
- Over 1 year in N-methyl-2-pyrrolidone at 232°C (450°F)

\*Registered trademark of The Dow Chemical Company



Kalrez® and Kalrez® Spectrum™ are registered trademarks or trademarks from DuPont Performance Elastomers.

### 6. Compound Selection - Kalrez®

#### **Kalrez®: Durable, safe seals in virtually any environment**

Because of the unique chemical structure of the material, Kalrez® parts can provide the most durable seals at temperatures up to 326°C/620°F in virtually any chemical media. No other seal, including other perfluoroelastomers, can perform for such extended periods in such aggressive environments. Kalrez® parts provide an effective (and cost effective) solution in a variety of industries.

1. In chemical processing and petroleum refining, O-rings are used in mechanical seals, pump housings, reactors, mixers, compressor casings, valves, rotameters, and other equipment. Custom-designed parts are used as valve seats, packings, diaphragms, gaskets, and U-cups. Kalrez® parts can be specified as standard seals for most mechanical seal types.

2. In analytical and process instruments, septa, O-rings, diaphragms, valve seats, column fittings, ferrules, and gaskets, Kalrez® solves tough chemical sealing problems. They also provide exceptional outgassing resistance under high vacuum at temperatures 100°C / 232°F above the limits of other elastomers.

3. In chemical transportation, O-rings and other seals are used in safety relief and unloading valves to prevent leakage from tank trucks and trailers, rail cars, ships and barges carrying hazardous and corrosive chemicals. Compliance with new government restrictions can be easier with Kalrez® parts.

4. In semiconductor manufacturing operations, O-rings and other parts are utilized to seal aggressive chemical reagents and specialty gases required for processing silicon chips. Also, the combination of thermal stability and low outgassing characteristics are desirable in furnaces for growing crystals and in high vacuum applications.

5. In energy production, V-ring packer seals, O-rings, T-seals, and custom parts are used in sour gas and oil wells at pressure differentials up to 138MPa (20.000 psi) and temperatures of 232°C. Specialty electrical connector boots are used in logging equipment for gas, oil, and geothermal steam wells at temperatures up to 307°C / 575°F.

6. In aircraft and aerospace industries, lip seals, diaphragms, O-rings, and custom designed parts are used on aircraft engines and rocket propellant systems. Because of their excellent thermal stability and resistance to aero-lubricants fuels, hydraulic media, hydrazine, oxidizers such as dinitrogen tetroxide, and other aggressive fluids, Kalrez® parts are especially suited for a number of demanding applications.

**On the following pages, ERIKS presents the next generation of Kalrez® compounds from DuPont Performance Elastomers.**





### 6. Compound Selection - Kalrez®

#### Kalrez® Spectrum™ - long-term service and exceptional value in use

Chemical and hydrocarbon processors must contain some of the most hazardous materials used in manufacturing. Kalrez® Spectrum™ perfluoroelastomer parts were designed to reliably seal in the most demanding environments.

For applications where there are mixed streams, unknowns in the process, or process excursions, Kalrez® Spectrum™ 6375 provides the broadest chemical resistance. Kalrez® Spectrum™ 6375 withstands aggressive chemical families including acids, amines, bases, aldehydes, ethylene oxide, and hot water/steam. Such broad chemical resistance makes 6375 the preferred sealing material across many applications which will allow for seal standardization and lower part inventory.

For many years Kalrez® 4079 was the standard for difficult sealing applications. Today Kalrez® Spectrum™ 7075 offers an improved level of chemical resistance over 4079. Although Kalrez® Spectrum™ 6375 is the best choice for most applications requiring chemical resistance, 7075 is the choice for service at elevated temperatures.

#### Thermal resistance compatible with application requirements

An elastomer's thermal stability and chemical resistance are usually the first performance characteristics considered when determining elastomeric seal compatibility. Kalrez® Spectrum™ 6375 and 7075 provide end-users options based on specification requirements. Because the majority of the chemical and hydrocarbon processing environments operate below 260°C, Kalrez® Spectrum™ 6375 is a safe and economical choice for applications in a variety of harsh environments.

With an operating temperature up to 275°C and broad chemical resistance, 6375 provides reliable sealing in a variety of environments to allow for seal standardization and lower inventory.

For operating conditions above 275°C, Kalrez® Spectrum™ 7075 is the choice over Kalrez® Spectrum™ 6375. Kalrez® 4079 has been the product of choice in higher temperature applications for many years. Now 7075 provides better thermal resistance, compression set and sealing force retention, as well as an overall improvement in chemical resistance. This combination of properties makes it an excellent choice for applications in high temperatures or temperature cycling conditions that require good dynamic properties and excellent compression set.

#### Kalrez® Spectrum™ 6375 - Broad chemical resistance Kalrez® Spectrum™ 7075 - Thermal resistance

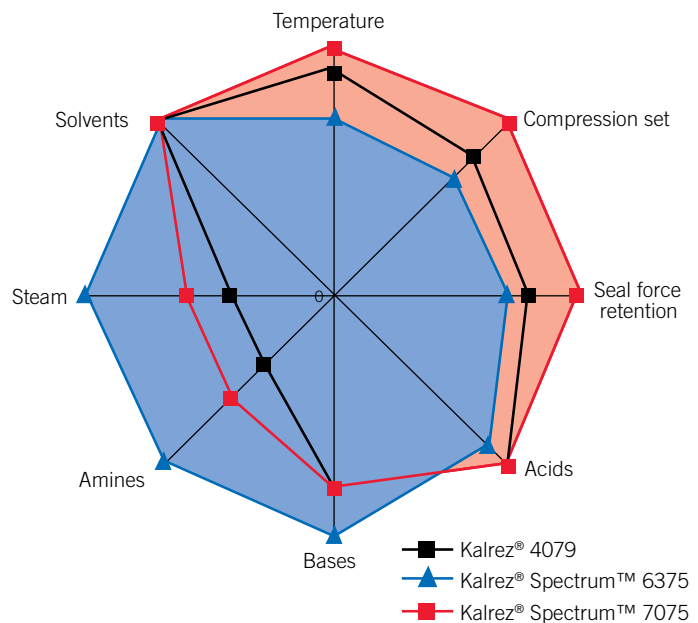

Table 2 - Chemical resistance

Chemical Resistance to:	Kalrez® Spectrum 7075	Kalrez® 4079	Kalrez® 6375
Aromatic/Aliphatic oils	++++	++++	++++
Acids	++++	++++	++++
Bases	+++	+++	++++
Alcohols	++++	++++	++++
Aldehydes	++++	+++	+++
Amines	++	+	++++
Ethers	++++	++++	++++
Esters	++++	++++	++++
Ketones	++++	++++	++++
Steam/Hot Water	++	+	++++
Strong Oxidizers	++	++	++
Ethylene Oxide	+++	x	++++
Hot air	++++	++++	+++

++++ = Excellent, +++ = Very good, ++ = Good, + = Fair, x = Not recommended.

### 6. Compound Selection - Kalrez®

#### Kalrez® Spectrum™ 6375

Kalrez® Spectrum™ 6375, designed specifically for the chemical process industry, combines new polymer technology with innovative patented curing technology. Compound 6375 is designed to give outstanding performance in the widest possible range of chemicals and temperatures.

This product is an excellent choice for use in acids, bases, amines, steam, ethylene oxide, and many other aggressive chemicals. Mixed streams, once a problem for many chemical processors, can now be handled by compound 6375. The new curing system also allows for a continuous upper service temperature of 275°C (525°F). This is approximately 40°C (100°F) higher than other products claiming broad chemical resistance. This high temperature stability translates to increased chemical resistance over all temperature ranges, especially if high temperature process excursions occur. This combination of chemical and thermal resistance provides advantages for chemical processors.

Today, chemical processors use several perfluoroelastomer parts, including compounds 4079, 1050LF, and 2035, to optimize chemical and thermal performance. Kalrez® Spectrum™ 6375 may be used in many applications to displace these products. However, if optimum chemical resistance is required, then applications must be individually reviewed for the optimum compound selection.

#### Typical Physical Properties

	6375	7075
Hardness, Shore A	75	75
100% Modulus <sup>2</sup>	7,2 MPa	7,58 MPa
Tensile Strength At Break	15,1 MPa	17,91 MPa
Elongation At Break	160%	160%
Compression Set <sup>3</sup> , 70h/204°C	30%	15%
Maximum Service Temperature	275°C (525°F)	327°C (620°F)

<sup>2</sup> ASTM D 412

<sup>3</sup> ASTM D 395 B, O-rings

#### Kalrez® Spectrum™ 7075

Kalrez® Spectrum™ 7075 joins the family of Kalrez® Spectrum™ products designed for the chemical processing industry. Compound 7075 broadens the family of Spectrum™ sealing options with enhanced physical performance properties including very low compression set and improved seal force retention. Kalrez® 7075 o-rings have a glossy finish for dynamic applications that may benefit from less drag.

Kalrez® Spectrum™ 7075 is designed for general-purpose use as o-rings or custom sealing components in the chemical and hydrocarbon processing industries. It is a carbon black-filled compound with mechanical properties designed for improved sealing performance in temperature cycling applications. 7075 has improved thermal resistance that extends maximum service temperature to 327°C (620 °F). It is not suggested for use in severe aqueous and amine applications where Kalrez® Spectrum™ 6375 remains the preferred compound. As always, we recommend the specific chemicals, service temperature and pressure be reviewed for the optimal compound selection in each application.

Kalrez® Spectrum™ 7075 offers very low compression set as measured by ASTM D395 to predict heat resistance. DuPont Performance Elastomers compression set testing extends the standard ASTM 70 hour protocol to include 336 and 672-hour compression set testing, which better predicts long-term o-ring performance. Less compression set results in improved sealing and longer service life.

Kalrez® Spectrum™ 7075 also offers approximately 10% higher seal force retention than Kalrez® 4079, as measured under the conditions of ISO 3384 (Figure 2). Higher seal force retention equates to better elastomeric properties at service temperature and pressure, resulting in more reliable, long-term seal performance.

### 6. Compound Selection - Kalrez®

#### Kalrez® Spectrum™ 7090

Kalrez® Spectrum™ 7090 - the latest addition to the Kalrez® Spectrum™ family of products - is targeted for static and dynamic sealing in applications requiring high hardness, higher modulus, and extrusion resistance at continuous service temperatures as high as 325°C.

Kalrez® Spectrum™ 7090 offers users an impressive combination of mechanical properties, including:

- outstanding compression set resistance and seal force retention,
- excellent response to temperature cycling effects,
- high resistance to rapid gas decompression,
- outstanding thermal stability and chemical resistance,
- lower coefficient of thermal expansion than other Kalrez® parts - minimizing need to increase free volume of seal gland when upgrading from FKM to FFKM.



#### Typical Physical Properties 7090

Hardness, Shore A	90
50% Modulus <sup>2</sup>	15,5 MPa
Tensile Strength At Break	22,75 MPa
Compression Set <sup>3</sup> , 70h/204°C	12%
Maximum Service Temperature	325°C (617°F)

<sup>2</sup> ASTM D 1414 & D 412 (AS568 K214 O-ring test specimen)

<sup>3</sup> ASTM D 1414 & D 395B (AS568 K214 O-ring test specimen)

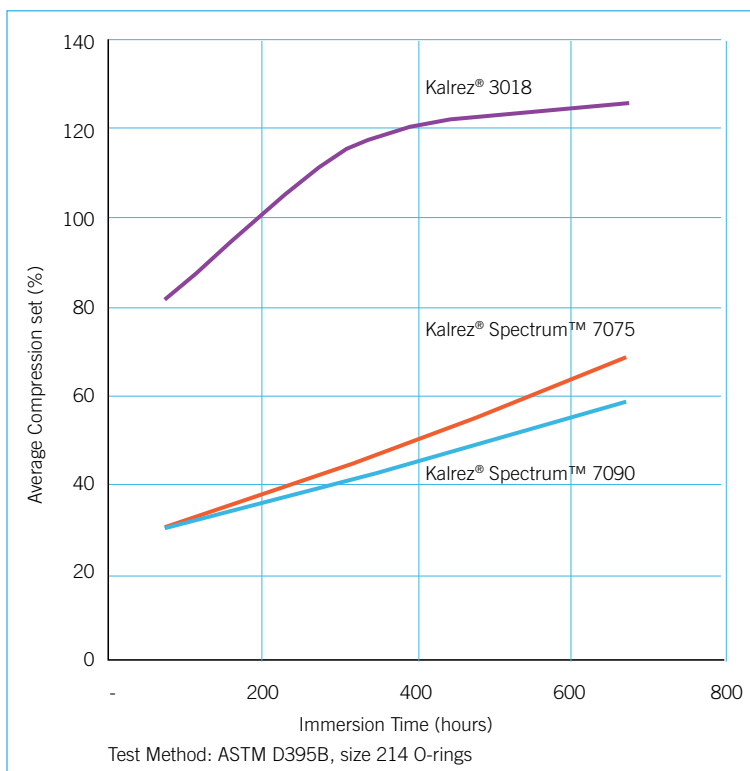

### 6. Compound Selection - Kalrez®



#### FAQs about Kalrez® Spectrum™

##### How are Kalrez® Spectrum™ products different from other Kalrez® products?

Kalrez® Spectrum™ perfluoroelastomer parts were designed to provide the best value and performance to meet the demands of the chemical and hydrocarbon processing industries (CPI/HPI) for broader chemical resistance, higher thermal resistance and better sealing force.

##### Which Kalrez® Spectrum™ product is best to use when my process has multiple chemical streams?

Kalrez® Spectrum™ 6375 has the broadest chemical resistance and is, therefore, more suitable for processes with multiple chemical streams or even unknown chemical streams. And, even if the process requires hot water flushes or steam cleaning, Kalrez® Spectrum™ 6375 will most likely handle the job.

##### What is best to use in my temperature-cycling process?

Kalrez® Spectrum™ 7075 has the highest thermal resistance and sealing force retention, which makes it suitable for processes which elevate in temperature for a period of time and then return to lower process temperatures, while retaining its resilient properties.

##### How economical are the Kalrez® Spectrum™ products?

Kalrez® Spectrum™ 6375 is more economical than other Kalrez® products. Additional savings may be obtained if you standardize on Kalrez® Spectrum™ 6375 to handle all your existing applications versus carrying multiple types in inventory. Kalrez® Spectrum™ 7075 should have comparable economics to Kalrez® products you have used in the past.

##### Is Kalrez® 4079 being phased out?

Absolutely not! Kalrez® 4079 has been the industry standard for over 20 years and is specified in many applications where it demonstrates outstanding performance. We will continue to make and supply our current products that meet the value and performance requirements of our many loyal customers and end users. In addition to our current product line, we will continue to develop the Kalrez® Spectrum™ line of products to meet the ever increasing requirements of the chemical and hydrocarbon industries.

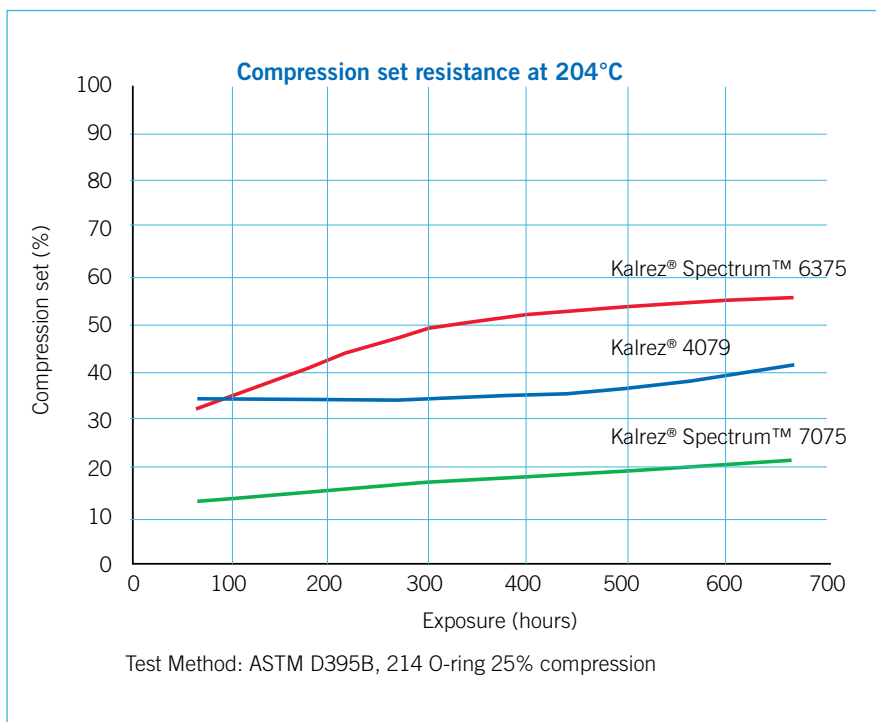

### 6. Compound Selection - Kalrez®



**Table 3 - Resistance to volume swell of Kalrez® Spectrum™ 6375 (1)**

Chemical	Temperature °C (°F)	Kalrez® Spectrum™ 6375	Nearest Competitive FFKM
Water	225 (437)	A	C
Glacial acetic acid	100 (212)	A	A
Nitric acid (70%)	85 (185)	B	C
Sulfuric acid (98%)	150 (302)	A	C
Ammonium hydroxide	100 (212)	B	B
Ethylene oxide	50 (122)	A	A
Epichlorohydrin	100 (212)	A	A
Butyraldehyde	70 (158)	A	B
Toluene diisocyanate	100 (212)	A	B
HCFC 134a	25 (77)	A	A

(1) Exposure time = 672 hours.

A = 1-10% volume swell, B = 10-20% volume swell, C = > 20% volume swell.

#### Kalrez® Spectrum™ 6375 combines low volume swell with good physical properties retention.

Low volume swell is critical to sealing performance in many applications. The result of lab testing to determine volume swell of Kalrez® Spectrum™ 6375 when exposed to some of the most aggressive fluids in the industry are shown here:

**Graph. 1**  
Volume change in ethylene oxide at 50°C, size 214 O-rings, ASTM D471

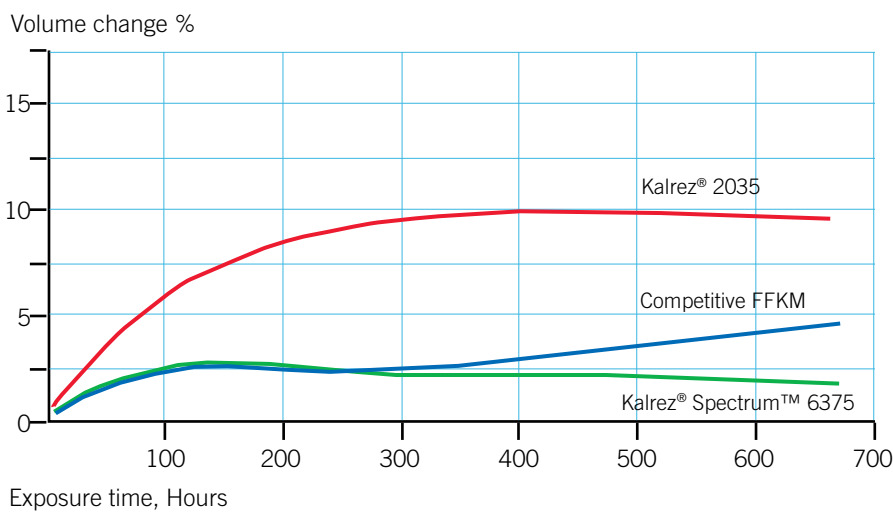

## 6. Compound Selection - Kalrez®



**Graph. 2**  
Volume change in 98% sulfuric acid at 150°C, size 214 O-rings, ASTM D471

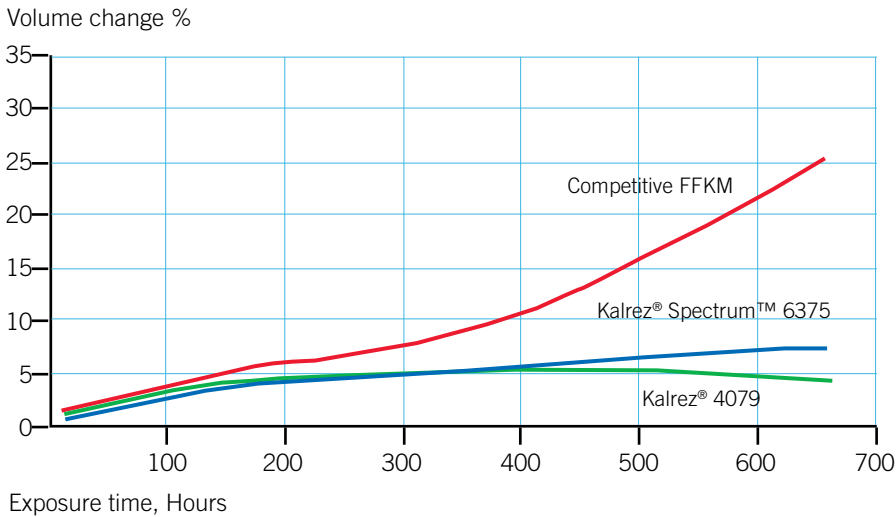

**Graph. 3**  
Volume change in toluene diisocyanate at 100°C, size 214 O-rings, ASTM D471

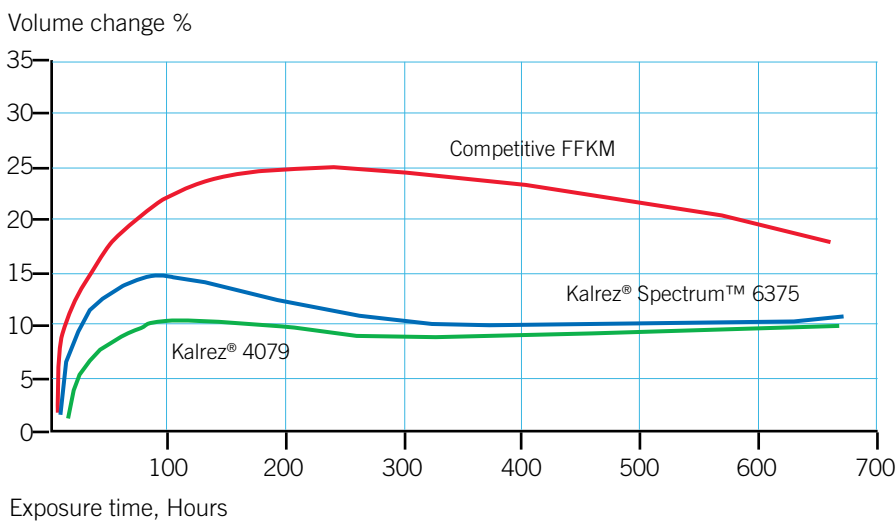

### 6. Compound Selection - Kalrez®



**Graph. 4 - Volume change in water at 225°C, size 214 O-rings, ASTM D471**

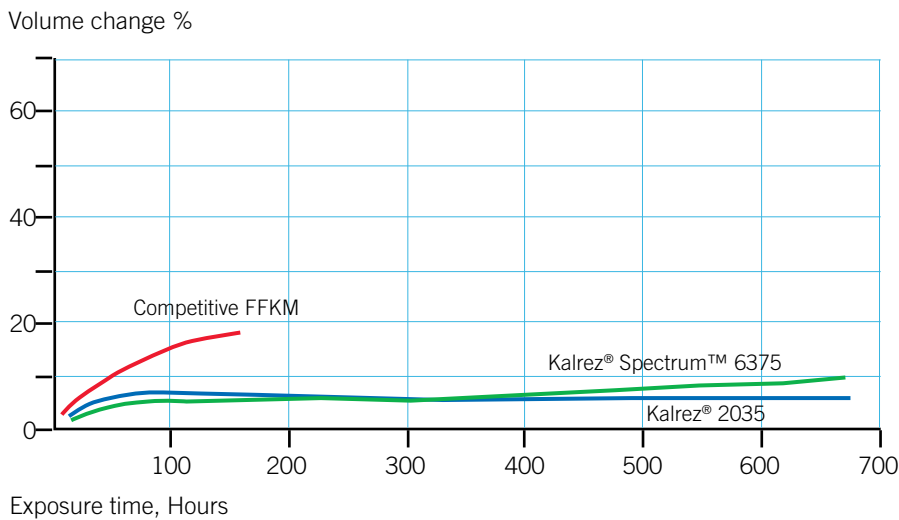

**Graph. 5 - Compression set at 240°C, size 214 O-rings, ASTM D471**

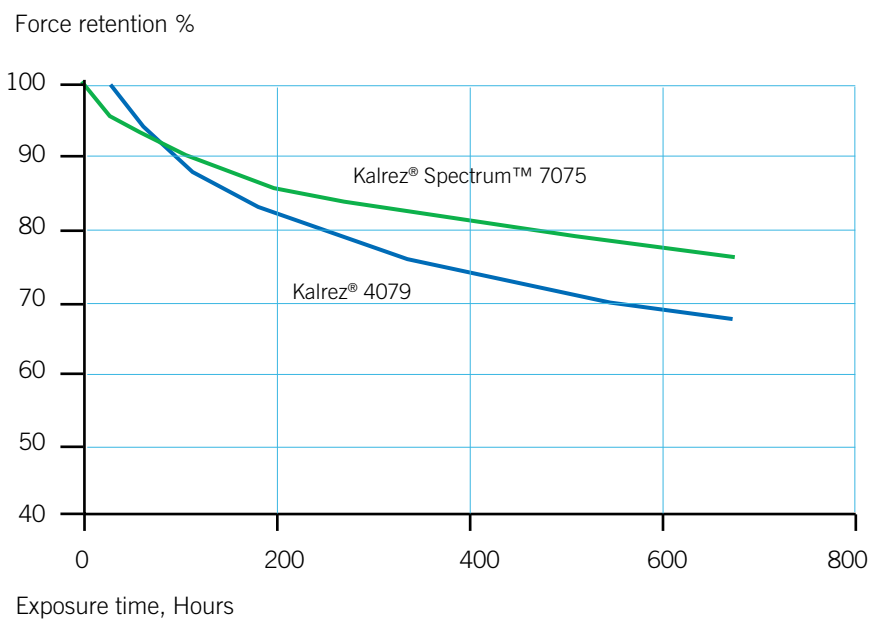

### 6. Compound Selection - Kalrez® in Semicon Industry

Chemical resistance that is nearly universal, coupled with superior high temperature properties, enables Kalrez® parts to withstand virtually any process media - including plasma - at temperatures up to 327°C (620°F).

By selecting the Kalrez® compound that is best suited to a specific application, processors can improve seal performance in all wafer fabricating operations, including thermal, gas/vacuum, dry plasma, and wet chemical systems.

#### Kalrez® gives long-term sealing performance at high temperatures

Kalrez® perfluoroelastomer parts retain elastic recovery properties and sealing force far better than other heat resistant elastomers - even after long term exposure at temperatures as high as 327°C (620°F). This thermal relaxation/stress aging test is a direct indication of long-term sealing effectiveness at elevated temperatures.

#### Kalrez® Spectrum™ 7075 offers new high temperature performance standard for the CPI industry

DuPont Performance Elastomers has unveiled Kalrez® Spectrum™ 7075, the first Kalrez® Spectrum™ product line expansion designed specifically for high temperature resistance in the chemical processing industry.

Customers have already reported exceptional seal performance in preliminary product testing, especially in mechanical seal applications.

Kalrez® Spectrum™ 7075 builds on the exceptional performance of Kalrez® 4079. By choosing 7075, customers will benefit from even longer seal life and increased mean time between repairs as a result of:

- Very low compression set at 204°C for 70 hours (15 %)
- Enhanced sealing force retention.
- Higher thermal resistance, up to 327°C / 620°F.

In addition 7075 offers broader chemical resistance and better cool down set recovery than Kalrez® 4079, and provides a smoother, glossier finish than other Kalrez® products.



#### Kalrez® 9100 – The New ‘Workhorse’ For Deposition Applications

The new Kalrez® 9100 exhibits ultra low particle generation and combines the best features of existing Kalrez® compounds for the semicon industry.

Kalrez® 9100 is an amber translucent product targeted specifically for deposition process applications, i.e., HDPCVD, PECVD, SACVD, Metal CVD, ALD, etc. It has also exhibited excellent performance in “select” etching and ashing/stripping process applications. Kalrez® 9100 has been specifically designed for low erosion and ultra-low particle generation in harsh plasma environments. It offers outstanding thermal stability, very low outgassing as well as excellent elastic recovery and mechanical strength properties and is well suited for both static and dynamic sealing applications. A maximum continuous service temperature of 300°C is suggested. Ultrapure post-cleaning and packaging is standard for all parts made from Kalrez® 9100.

Kalrez® 9100 has been reported to significantly improve wafer production in a variety of semiconductor process applications, i.e., HDPCVD, PECVD, etching, ashing, etc., where oxygen and fluorinated plasmas are used during the cleaning cycle. In a number of evaluations at fab line customers, Kalrez® 9100 exhibited less erosion, lower particle generation and longer seal life compared to competitive perfluoroelastomers in both static and dynamic sealing applications.

#### Kalrez® Application Guide

The Kalrez® Application Guide is ready to be downloaded from the internet in the always up-to-date version.

The easy guide to choosing the best perfluoroelastomer seal for an application now includes the latest chemical processing and semi-conductor compounds from Kalrez®. It helps in compound selection by rating the resistance of Kalrez® compounds to virtually any combination of temperature and chemical media, and it helps you in seal design.

The seal design selection will assist in designing a groove for a specific O-ring, and calculate seal performance parameters in various temperature and swell conditions at minimum and maximum O-ring groove tolerance.

**Download NOW at: [www.dupontelastomers.com](http://www.dupontelastomers.com)**



### 6. Compound Selection - Kalrez® in Semicon Industry

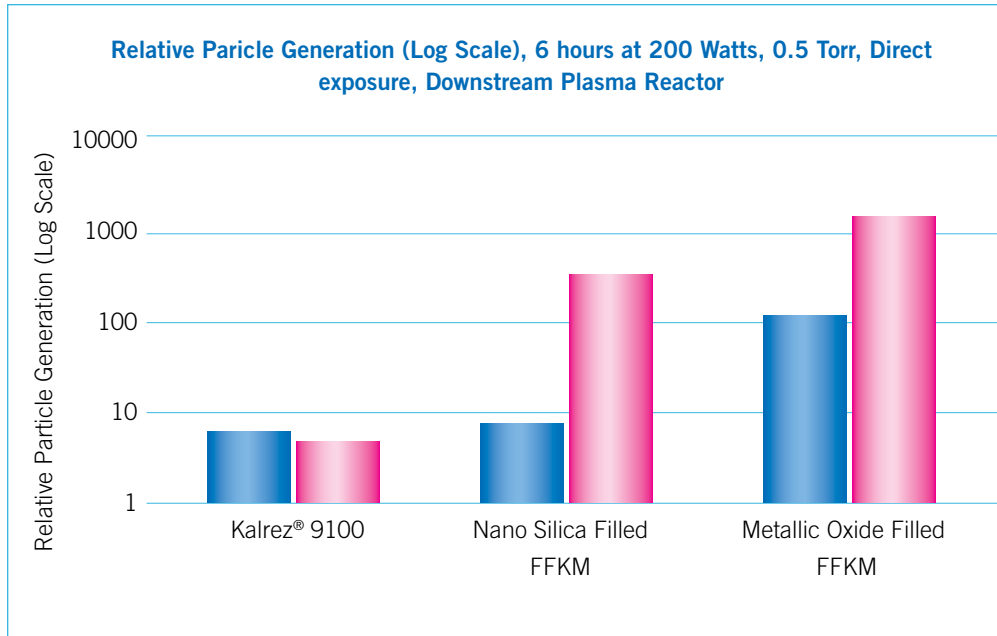

#### Kalrez® for specific semicon processes

Semicon Process	Suggested Compound
Plasma	<p>9100 - Optimum for deposition process applications. Low erosion rate and ultra-low particle generation in oxygen and fluorine-based plasmas. Excellent elastic recovery properties.</p> <p>Alternatively:</p> <p>8085 - General purpose product for all plasma processes. Excellent mechanical strength properties.</p> <p>8002 - Transparent product for “select” plasma process applications. Ultra-low particle generation in oxygen and fluorine-based plasmas.</p>
Thermal	<p>7075UP - Optimum for LPCVD, ALD, oxidation and diffusion thermal process applications.</p> <p>8475 - Optimum for lamp anneal and RTP thermal process applications.</p>
Wet	<p>6375UP - Optimum for wet process applications.</p> <p>Alternatively:</p> <p>4079 - Excellent chemical resistance.</p> <p>1050LF - Excellent amine resistance.</p>

### 6. Compound Selection - Kalrez® in Semicon Industry

#### Suggested Products for Semiconductor Use

**Kalrez® 9100** is an amber translucent product targeted specifically for deposition process applications, i.e., HDPCVD, PECVD, SACVD, Metal CVD, ALD, etc. It has also exhibited excellent performance in “select” etching and ashing/stripping process applications. Kalrez® 9100 has been specifically designed for low erosion and ultra-low particle generation in harsh plasma environments. It offers outstanding thermal stability and very low outgassing as well as excellent elastic recovery and mechanical strength properties and is well suited for both static and dynamic sealing applications (e.g., gas inlet seals, gas orifice seals, chamber lid seals, isolation valve seals, bonded gate valve/slit valve door seals, etc.). A maximum continuous service temperature of 300°C is suggested.

**Kalrez® Sahara™ 8085** is a beige, general purpose product for all plasma process applications, i.e., etching, ashing/stripping, HDPCVD, PECVD, SACVD, etc. It has been formulated for minimal particle generation in NF3 plasma. Kalrez® Sahara™ 8085 exhibits very low particle generation and low weight loss in oxygen and fluorine-based plasma, has excellent mechanical properties and is well-suited for both static and dynamic sealing applications (e.g., bonded slit valve doors, bonded gate valves, bonded pendulum valves, gas orifice seals, gas inlets, gas feedthrough seals, chamber lid seals, etc.). A maximum continuous service temperature of 240°C is suggested. Kalrez® Sahara™ 8085 can also withstand short-term excursions up to 275°C.

**Kalrez® 8002** is a clear, transparent product targeted specifically for “select” plasma process applications, i.e., etching, ashing/stripping, deposition etc. This unfilled product offers ultra-low particle generation in oxygen and fluorine-based plasmas versus mineral-filled products. Kalrez® 8002 exhibits excellent resistance to dry process chemicals, has good mechanical properties and is well suited for static, low stress/low sealing force and “select” bonded door seal applications. A maximum continuous service temperature of 275°C is suggested.

**Kalrez® 7075UP** is a black product targeted specifically for semiconductor oxidation, diffusion furnace and LPCVD thermal process applications. It offers outstanding thermal stability, very low outgassing and excellent compression set properties. Kalrez® 7075UP exhibits excellent seal force retention, has good mechanical properties and is well suited for both static and dynamic sealing applications. A maximum continuous service temperature of 327°C is suggested. Short excursions to higher temperatures may also be possible.

**Kalrez® Sahara™ 8475** has been specifically developed to meet the challenging requirements associated with sealing applications in semiconductor thermal processes (i.e., oxidation, diffusion furnace, LPCVD, RTP, lamp anneal, etc.). It exhibits excellent thermal stability and long-term sealing performance, less IR absorption and significantly reduced outgassing properties at elevated temperatures. Kalrez® Sahara™ 8475 has good mechanical properties and is well-suited for static and low stress/low sealing force applications (e.g., quartz tube seals, ball joint seals, bell jar seals, plenum seals, etc.). A maximum continuous service temperature of 300°C is suggested.

**Kalrez® 6375UP** is a black product for semiconductor wet process applications. This product exhibits excellent chemical resistance to all different types of wet process chemicals including acids, bases and amine-base strippers. It features low elemental extractables with good mechanical and compression set properties and is well-suited for both static and dynamic wet process seal applications (e.g., filter seals, drain seals, flowmeters). A maximum continuous service temperature of 275°C is suggested.

More Kalrez® compounds for use in select semicon applications available.

Ultrapure post-cleaning and packaging is standard for parts made from Kalrez® 9100, Sahara™ 8085, 8002, 7075UP, Sahara™ 8475 and 6375UP.



### 6. Compound Selection - specials



#### Kalrez® Compounds

Kalrez® Compound	Hardness (Shore A)	Tensile Strength (MPa)	Compression Set (%)*	Max. Service Temp. (°C/°F)	Colour	Segment	Application
Spectrum 6375	75	15,16	25	275 / 527	Black	CPI	Broadest chem. resistance
Spectrum 7075	75	17,91	12	327 / 620	Black	CPI	High temp., temp. cycles
4079	75	16,88	25	316 / 600	Black	CPI	General
1050LF	82	18,6	35	288 / 550	Black	CPI	General, steam, amines
1058	65	8,96	40	260 / 500	Black	CPI	Applications require low sealing force
3018	91	21,7	35	288 / 550	Black	CPI	High pressure, steam
2037	79	16,88	27	220 / 428	White	CPI	Oxidizing environment
6221	70	15,16	31	260 / 500	White	Pharma/Food	FDA, USP
6230	75	16,54	30	260 / 500	Black	Pharma/Food	FDA, USP
9100	74***	11,85	17**	300 / 572	Amber translucent	Semicon	Deposition processes
8085	80	16,3	42**	240 / 464	Beige	Semicon	Plasma
8002	69	15,95	15**	275 / 527	Clear translucent	Semicon	Selected plasma
Spectrum 7075UP	75	17,91	15	327 / 620	Black	Semicon	Thermal
8475	60	11,35	23**	300 / 572	White	Semicon	Thermal
Spectrum 6375UP	75	15,16	25	275 / 527	Black	Semicon	Wet
8575	62		29	300 / 527	White	Semicon	Selected etching, ashing stripping and deposition
4079	75	16,88	25	316 / 600	Black	Semicon	Wet
2037	79	16,88	27	220 / 428	White	Semicon	Selected plasma and gas deposition
1050LF	82	18,6	35	288 / 550	Black	Semicon	Selected wet with high amine content
Spectrum 7090	90	22,75	12	325/617	black	CPI	High pressure, high temperature

In collaboration with DuPont Performance Elastomers ERIKS offers an FEA analysis of sealing applications to aid in the correct selection of Kalrez® O-ring compounds.

\*acc. to ASTM D 395B (pellet test specimen unless otherwise noted)

\*\*acc. to ASTM D 395B and ASTM D 1414 (AS568A K214 O-ring test specimens)

\*\*\*Shore M acc. to ASTM D 2240 and ASTM D 1415 (AS568A K214 O-ring test specimens)

### 6. Compound Selection - Encapsulated Teflex

#### 1. Why are Teflex O-Rings needed?

There are certain applications which prohibit the use of conventional rubber O-Ring seals. The use of hostile chemicals or extreme temperatures (both high and low) during various processes can make effective sealing very difficult. Many seal manufacturers have produced different "high performance" materials for these applications. ERIKS has contributed to this area by introducing Teflex. The following is the summary of these "high performance" products compared with Teflex.

#### Solid PTFE

Solid PTFE O-Rings enjoy true chemical inertness. This is the only advantage over Teflex. PTFE suffers badly from cold flow and has little memory to return to its original form.



#### PTFE enveloped

Enveloped O-Rings too enjoy true chemical inertness and are low in cost to produce. The design of the PTFE envelope may allow the chemical to reach and attack the core material resulting in premature failure.



#### PTFE coated

O-Rings coated with suspended PTFE dispersion give some low friction properties but the coating is easily removed. This method of manufacture is low in cost but offers practically no chemical protection.



#### Perfluoroelastomer

A Perfluoroelastomer is the most technically advanced O-Ring material for corrosive applications. O-Rings made from Perfluoro offer very easy installation properties and display conventional elastomer characteristics.



#### Metallic (Tubular)

Tubular metallic O-Rings offer very good chemical resistance, high pressure ability, and flexible temperature ranges. They do however require very precise housing and surface finish detail and again can be quite expensive to produce.



There are certain applications for which we would not recommend the use of Teflex.

- Dynamic use where high speeds and poor surface finishes are encountered.
- Where the housing design requires excessive stretch. Teflex is very difficult to stretch.
- When the media in contact with the O-Ring has an abrasive nature, sand, slurry, etc..

#### 2. Introduction to Teflex

A Teflex O-Ring comprises an elastomeric energising core, which has a seamless jacket made from a fluoropolymer.

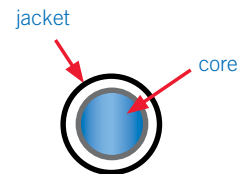

The elastomeric core may be Viton® or Silicone. The jacket is made from Teflon® FEP or PFA.

10 years of experience with these O-Rings indicate this product is a perfect sealing solution for typical applications. ERIKS' world-wide experience with thousands of applications ensures that Teflex is a quality product.



### 6. Compound Selection - Encapsulated Teflex

#### 3. Material specifications

FEP is a copolymer of hexafluoropropylene and TFE.  
 PFA is also a copolymer of TFE but with perfluorinated ether.  
 ERIKS Viton® compound has been designed specifically to give optimum compression set characteristics.  
 This feature is paramount in the cores function of energising the Teflon jacket and aiding its recovery from compression.

#### ERIKS Viton® compound meets the following specifications:

Hardness:	ASTM D 2240	75° ± 5° Shore 'A'
Tensile strength:	ASTM D 412	min. 10.7 MPa
Elongation:	ASTM D 412	min. 213%
Specific weight:	ASTM D 1817	2.32 ± 0.04
Compression set:	ASTM D 395B	
on slab		4.6% (175°C)
on O-Ring 5mm		< 10% (200°C)

#### Heat ageing **ASTM D 573**

Hardness	+3°
Tensile strength	+15%
Elongation change	-29%

#### ERIKS silicone compound meets the following specification:

Hardness:	ASTM D 2240	min. 70 ± 5° Shore 'A'
Tensile strength:	ASTM D 412	min. 8.6 MPa
Elongation:	ASTM D 412	min. 280%
Specific weight:	ASTM D 1817	1.26
Compression set:	ASTM D 395B	
22h/175°		< 32%

Silicone is FDA compliant.



#### 5. Installation

The correct installation of Teflex O-Rings is essential for prolonged seal life. A very large percentage of seal problems are caused by incorrect fitting procedures.

To fit a Teflex O-Ring into an internal bore type housing the seal needs to be collapsed. This is best achieved by immersing the seal in hot water (60°-80°C) prior to fitting which gives much greater flexibility to the jacket. Take the seals out of the water one at a time and quickly slide the seal into the bore passing the leading edge over and past the groove. It is important that the groove is chamfered and free from burrs or damage will be caused to the jacket. After the trailing edge of the seal is located into the groove, the leading edge has to be pulled backwards taking care to apply even pressure around the circumference of the seal to avoid kinking of the jacket.

Snap the O-Ring into the groove and smooth out evenly. It may be wise to insert the shaft before the O-Ring cools down. It is important that the surface finish should not exceed 20 microinch.

#### 4. Markets and applications

There is hardly a market in which Teflex O-Rings are not currently utilised and they are very well established in the following industries: chemical processing and production, oil extraction, petrochemical refining, pharmaceutical production, food and drink processing, paint and die manufacture, refrigeration engineering, cosmetics and perfumery, automotive components, and aerospace engineering.

##### Mechanical seals

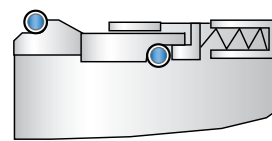

##### Filter elements



##### Mixers and vessels

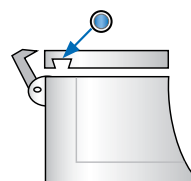

##### Heat exchangers

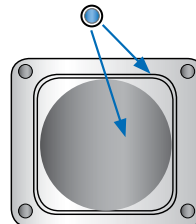

##### Valves

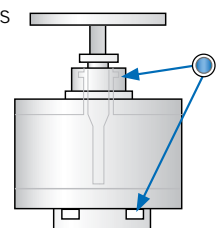

##### Pumps

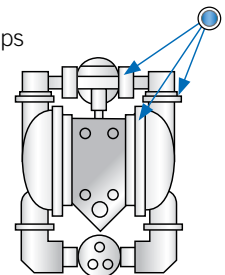

##### Flanges

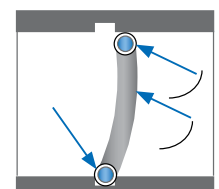
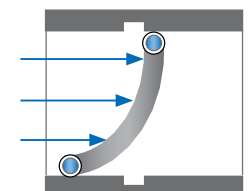
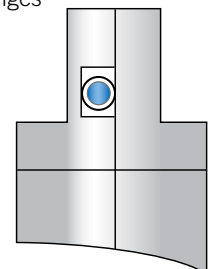

### 6. Compound Selection - Encapsulated Teflex

#### 6. Availability

The following are examples of such formats but we would consider any requests for special items not displayed here.

#### Circular

Circular shapes are by far the most common and account for over ninety percent of the current production. Available as small as 5 mm inside diameter with no upper diameter limit.

#### Oval

Oval shapes are used mainly in "inspection hatch" applications on chemical vessels. ERIKS can produce most of the common hatch sizes as well as non standards.

#### Semi circular

Semi circular shapes are used for both inspection hatch and heat exchanger sealing. There are no standard sizes available but tooling costs are very low so most applications are worth serious consideration.

#### Square and rectangular

Square and rectangular shapes are used in many applications such as heat exchanger plate and pump housings. All the above shapes (excluding circular) have to be produced with radiused corners and are priced on application.

#### FEP Jacket on solid Viton® core



This is the most popular combination and indeed the most technically capable in providing a compression seal. The Viton® core compound has been specifically formulated to give very low compression set results and this characteristic speeds up the somewhat slow memory of the FEP jacket. The temperature range is -20°C to +204°C / -20°F to +392°F.

#### FEP Jacket on solid Silicone core



This combination again is very popular and this is due to lower cost against that of the Viton® core. Technically it is inferior to Viton® except when used for low temperature use. The temperature range is -60°C to +204°C / -76°F to +392°F.

#### PFA Jacket on solid Viton® core



PFA offers higher abrasion resistance to that of FEP and the cost is approximately 50% higher. The temperature range is -20°C to +204°C / -4°F to +392°F.

#### PFA Jacket on solid Silicone core



This combination is preferred for higher temperature applications. The PFA jacket shares the same temperature service limits as the Silicone core.

The temperature range is -60°C to +260°C / -76°F to +500°F.

#### FEP Jacket on hollow Silicone core or hollow Viton® core



Used commonly where low seal loading is encountered. For slow reciprocating or rotary movement, the hollow core does not offer as much of an energising load thus reducing jacket wear and premature failure.

#### PFA Jacket on hollow Silicone core or hollow Viton® core



Used for the same applications as FEP on hollow Silicone core or hollow Viton® core but when additional abrasion resistance is necessary to prolong the seal life.

#### FEP Jacket on Solid Viton® or Silicone core



Rectangular and square sections can be produced and ERIKS has a standard range of gaskets in the price list section for cam action type hose couplings. These provide a far superior alternative to envelope gaskets or solid PTFE joints. The temperature range is -20°C to +204°C / -4°F to +392°F.

### 6. Compound Selection - Encapsulated Teflex

#### 7. Size range

Teflex O-Rings are manufactured according to standard sizes:

- Metric
- BS 1806
- BS 4518
- AS 568, AS 871
- JIS B2401
- and also as non-standards to customer requirement.

#### Size range

##### smallest inside Ø possible (in mm)

Cord (mm)	Viton® Core	Silicone Core	Silicone/Viton® Hollow Core
1,60	10,00	5,00	not possible
1,78	10,00	5,28	8,0
2,00	10,00	6,80	10,00
2,50	12,00	7,40	12,00
2,62	12,00	7,60	16,00
3,00	15,00	12,00	20,00
3,40	15,00	12,50	23,00
3,53	15,00	13,00	24,00
4,00	16,00	14,00	28,00
4,25	17,00	14,50	32,00
4,50	18,00	15,00	35,00
5,00	22,00	20,00	42,00
5,33	25,00	22,00	48,00
5,50	27,00	23,00	50,00
5,70	27,00	24,00	60,00
6,00	30,00	27,00	75,00
6,35	40,00	40,00	90,00
6,99	50,00	50,00	100,00
8,00	75,00	75,00	150,00
8,40	80,00	80,00	160,00
9,00	100,00	100,00	175,00
9,52	120,00	105,00	200,00
10,00	140,00	110,00	230,00
11,10	150,00	115,00	250,00
12,00	180,00	120,00	300,00
12,70	190,00	130,00	350,00

There is no upper limit to inside diameters. Please refer to the design and installation section for housing details.

It is not recommend to stretch O-Rings smaller than 12 mm inside diameter. This often results in breakage of the core which is not vulcanised on small sizes.

#### Thickness of the FEP/PFA jacket:

Following thickness are standard:

Ø section	Thickness FEP/PFA
from 1,78 mm	0,24 mm
from 2,62 mm	0,34 mm
from 3,53 mm	0,36 mm
from 5,34 mm	0,50 mm
from 6,99 mm	0,55 mm

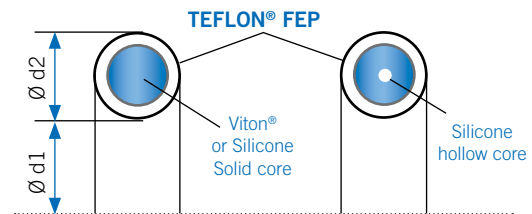

### 6. Compound Selection - Encapsulated Teflex

#### Cross Section Tolerances

The cross sectional tolerances for Teflex O-Rings differ to those achievable with moulded O Rings.

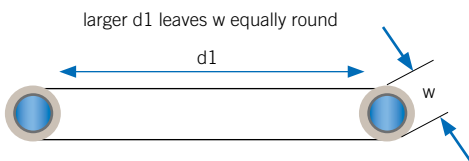

If an Teflex O-Ring is produced with a medium to large inside diameter ( $d_1$ ) the cross sectional diameter ( $w$ ) remains reasonably round.

However, when Teflex O-Rings are produced with small inside diameters, the cross section ( $w$ ) takes a degree of ovality. This is due to the memory of the jacket material and the result is that the axial height ( $a$ ) may become greater than the radial width ( $r$ ).

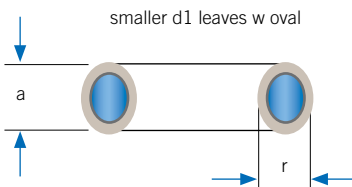

This cross section ovality means that a wider set of tolerances have to be applied to Teflex O-Rings as per the following chart.

Note however that hollow core rings cannot be produced as small as solid rings, see range of diameters applicable to hollow core in previous chart.

**Teflex® O-Ring Cross Section Tolerances**

Cross section tolerance depending on O-ring inner diameter			
(w)	d1 to d1	w±	d1 > w±
1.60	5.00 - 10.0	0.12	0.10
1.78	5.28 - 12.0	0.12	0.10
2.00	6.80 - 15.0	0.12	0.10
2.40	7.40 - 17.0	0.15	0.12
2.50	7.40 - 17.0	0.15	0.12
2.62	7.60 - 18.0	0.15	0.12
3.00	12.0 - 20.0	0.20	0.15
3.40	12.5 - 22.5	0.20	0.15
3.53	13.0 - 25.0	0.20	0.15
3.60	13.0 - 25.0	0.20	0.15
4.00	14.0 - 30.0	0.30	0.25
4.25	14.5 - 35.0	0.30	0.25
4.50	15.0 - 40.0	0.30	0.25
5.00	20.0 - 45.0	0.30	0.25
5.34	22.0 - 50.0	0.30	0.25
5.50	23.0 - 52.0	0.30	0.25
5.70	24.0 - 54.0	0.30	0.25
6.00	27.0 - 56.0	0.35	0.30
6.35	40.0 - 58.0	0.35	0.30
6.50	45.0 - 59.0	0.35	0.30
6.99	50.0 - 60.0	0.35	0.30
8.00	75.0 - 90.0	0.45	0.40
8.40	76.0 - 100.0	0.45	0.40
9.00	95.0 - 125.0	0.45	0.40
9.52	105.0 - 150.0	0.45	0.40
10.00	110.0 - 170.0	0.60	0.50
10.50	112.0 - 180.0	0.60	0.50
11.10	115.0 - 200.0	0.60	0.50
12.00	120.0 - 250.0	0.60	0.50
12.70	130.0 - 300.0	0.60	0.50
14.00	180.0 - 300.0	0.60	0.50
14.30	180.0 - 400.0	0.75	0.60
15.00	250.0 - 450.0	0.75	0.60
15.90	280.0 - 500.0	0.85	0.70
18.00	325.0 - 700.0	1.00	0.80
19.05	350.0 - 750.0	1.00	0.80
20.63	400.0 - 875.0	1.00	0.90
25.40	425.0 - 1000.0	1.25	0.90
30.00	475.0 - 1250.0	1.50	1.20
32.00	500.0 - 1500.0	1.75	1.50



### 6. Compound Selection - Encapsulated Teflex

#### Inside Diameter (d1) Tolerance

It is not possible to produce Teflex O-Rings to the same inside diameter tolerance as a moulded O-Ring.

Due to the temperature sensitivity of Teflon®, Teflex O-Rings are produced and controlled to conform with ISO 3302-1 M2F.

d1	tol
5.0mm thro 16.0mm	+/- 0.20
16.0mm thro 25.0mm	+/- 0.25
25.1mm thro 40.0mm	+/- 0.35
40.1mm thro 63.0mm	+/- 0.40
63.1mm thro 100.0mm	+/- 0.50
100.1mm thro 160.0mm	+/- 0.70
thereafter the tolerance will be of thenominal inside diameter of the ring	+/- 0.5%
example : inside diameter of 310.0mm	
tolerance = +/- 1.55mm (0.5%)	

#### 8. Chemical resistance

FEP and PFA Teflex O-Rings don't absorb most chemical until the temperature reaches 200°C. In the next diagram are the absorption figures at different temperatures:

Chemical product	Temp °C	Time	% Absorption
Aniline	185	168 h	0,3
Benzaldehyde	200	168 h	0,7
Tetrachloride	78	168 h	2,3
Freon 113	47	168 h	1,23
Nitrobenzene	210	168 h	0,8
Toluene	110	168 h	0,8
Sulfuric acid 50%	100	168 h	0,01
Phosphoric acid	100	168 h	0,01
Sulfuric acid 30%	70	1 year	0
Chlorid acid 20%	70	1 year	0
Aceton	70	168 h	0
Benzene	78	168 h	0,5

#### 9. Compressive load requirements

Designers may require information showing details of compressive load required for Teflex O-Rings. In order to provide this information, ERIKS conducted tests on each of the common cross sectional diameters within our range of products. Samples were taken from typical production batches and tested to 10,15, and 20% compression rates.

It is possible, using the following table, to obtain the total force required to effect a desired compression of a Teflex O-Ring, thus allowing accurate selection of sufficient mechanical loading.

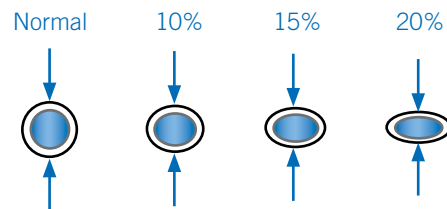

DIAM. mm	VITON® SOLID CORE Compression			SILICONE SOLID CORE Compression			SILICONE HOLLOW CORE Compression		
	10%	15%	20%	10%	15%	20%	10%	15%	20%
	1,60	16	26	40	20	33	48		
1,78	26	40	53	22	35	48			
2,00	34	53	77	30	46	59			
2,50	40	66	95	40	59	78			
2,62	29	44	64	23	38	53			
3,00	70	107	140	36	60	82	27	38	50
3,53	54	91	120	32	57	83	28	44	58
4,00	51	82	111	56	87	108	23	36	45
4,50	75	107	139	53	84	110	41	55	65
5,00	91	126	182	39	64	89	50	70	87
5,34	82	117	145	96	138	191	54	77	94
5,50	45	83	116	37	65	93			
5,70	79	116	115	58	88	112			
6,00	86	126	169	53	86	113	46	72	91
6,99	95	135	201	101	135	201	46	63	80
8,00	101	147	213	82	122	163	66	96	121
9,52	115	173	247	84	125	175			
10,00	122	192	281	117	174	246			
12,00	124	194	279	59	93	126			

Figures in N/25mm length

### 6. Compound Selection - Encapsulated Teflex

#### 10. Groove dimensions

**Table 1 - Piston/Rod Sealing Application**

∅	't'	'b'
1.60	1.20	1.90
1.78	1.30	2.30
2.00	1.50	2.60
2.50	1.90	3.20
2.62	2.00	3.40
3.00	2.30	3.90
3.53	2.75	4.50
4.00	3.15	5.20
4.50	3.60	5.80
5.00	4.00	6.50
5.34	4.30	6.90
5.50	4.50	7.10
5.70	4.65	7.40
6.00	4.95	7.80
6.35	5.25	8.20
6.99	5.85	9.10
8.00	6.75	10.40
8.40	7.20	10.50
9.00	7.70	11.70
9.52	8.20	12.30
10.00	8.65	13.00
11.10	9.65	14.30
12.00	10.60	15.60
12.70	11.45	16.80

**Table 2 - Axial Face Sealing Application**

∅	't'	'b'
1.60	1.20 ± 0.05	2.10
1.78	1.30 ± 0.05	2.30
2.00	1.50 ± 0.05	2.60
2.50	1.90 ± 0.05	3.20
2.62	2.00 ± 0.05	3.40
3.00	2.30 ± 0.05	3.90
3.53	2.75 ± 0.05	4.50
4.00	3.15 ± 0.05	5.20
4.50	3.60 ± 0.05	5.80
5.00	4.00 ± 0.05	6.50
5.34	4.30 ± 0.05	6.90
5.50	4.50 ± 0.05	7.10
5.70	4.65 ± 0.05	7.40
6.00	4.95 ± 0.05	7.80
6.35	5.25 ± 0.05	8.20
6.99	5.85 ± 0.05	9.10
8.00	6.75 ± 0.10	10.40
8.40	7.15 ± 0.10	10.90
9.00	7.70 ± 0.10	11.70
9.52	8.20 ± 0.10	12.30
10.00	8.65 ± 0.10	13.00
11.10	9.70 ± 0.10	14.30
12.00	10.60 ± 0.10	15.60
12.70	11.40 ± 0.10	16.70

Table 1

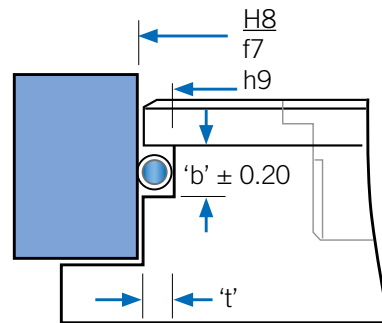

Table 1

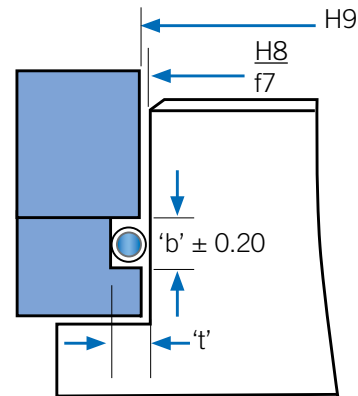
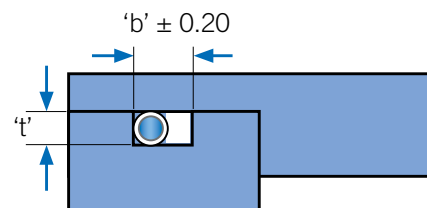

Table 2



## 6. Compound Selection - Encapsulated Teflex

### 11. Approvals

#### FDA: Food and Drug Administration

This data pertains to the US Federal Food and Drug Administration regulations governing the use of fluoropolymers as articles or components intended for use in contact with food.

The Teflon FEP and PFA resins used to produce Teflex may be used as articles or components to contact food in compliance with FDA Regulation 21 CFR 177.1550.

This specification includes acceptance by The United States Department of Agriculture for direct use in contact with meat or poultry food products and Food Industries Supply Association Inc for product contact surfaces for Dairy Equipment.

USP Class VI requirements are met by Teflon FEP and PFA for use in Pharmaceutical Processing.

Teflon FEP is approved for use with potable water under section 5296 certificate no 930716.

#### Teflon FEP - CONFORMITY

21 CFR 177.1550	21 CFR 177.2600	21 CFR 175.105
21 CFR 176.180	21 CFR 177.1520	21 CFR 175.300
21 CFR 176.170		

#### Teflon PFA - CONFORMITY

21 CFR 177.1550	21 CFR 175.105	21 CFR 176.180
21 CFR 175.300	21 CFR 176.170	

Viton® can be produced compliant to FDA.

### 12. Quality control and inspection

ERIKS only uses the very best available materials and components from manufacturers such as Dupont Performance Elastomers. The laser micrometer inspection equipment is state of the art and every single Teflex O-Ring which leaves the warehouse has been individually checked for visual and mechanical compliance. Dimensional inspection AQL is 10% unless otherwise agreed. ERIKS is able to offer 100% control on dimensions.

Prior to dispatch large Teflex O-Rings may be twined and coiled to reduce shipping costs. It is advised to uncoil the ring upon receipt. If this is not done, after some length of time it may be necessary to place the seal in hot water or an oven (max 80°C) for 10-20 minutes to allow the seal to return to shape.

### 6. Compound Selection - Encapsulated Teflex

#### 13. Answers to popular questions

##### Is it possible to produce Teflex O-Rings with an EPDM or NBR core?

It is possible with special EPDM (white or black). Due to the high temperatures involved in the production process it is not possible to produce Teflex O-Rings around normal elastomers.

##### Is 48 hours emergency production possible?

It is possible if we take down the set up of the actual production. So these O-Rings are more expensive.

##### Why are small O-Rings relatively more expensive?

Every O-Ring is made by hand. As one can imagine the very small items have to be manufactured, sized, and inspected in the same way as larger O-Rings but the process is much longer.

##### Are other cross sections possible than the standard ones?

Due to a special process ERIKS produces special cross section sizes. Tooling costs are necessary.

##### Are special core materials possible?

Yes. Now we are able to offer special core materials like Viton(R) GF, USP Class VI or metal detectable grades. Please contact us for more information.



## 6. Compound Selection - Metal C- and O-rings

Metal c- and o-rings are used in a wide range of industrial applications, where the use of elastomeric o-rings are restricted by temperature, corrosion, radiation, pressure, gas permeation or life time requirements.

As an elastomeric o-ring a metal c- or o-ring seals due to its resilience characteristics. Also the sealing performance will increase significantly due to pressure energization. That means that the hydrostatic pressures are used to benefit the self-energization of the seal. Especially at high pressures this becomes a “sealing-advantage” and enables metal c- and o-rings to seal at 200 MPa and more.

### General Properties

- Sizes: Diameters from 5 mm to 7 meter.
- Cross section from 0,79 mm to 12,70 mm.
- Temperature: Cryogenic to +750°C.
- Pressure: From ultra high vacuum to +500 MPa.
- Available in circular, race track, oval and other shapes.
- Excellent resistance to corrosion and radiation.
- Maintains elasticity or spring back over an extended service life.
- Does not suffer from explosive decompression.
- Capable of reaching tightness better than 10<sup>-9</sup> mbar.l/s.
- Radiation resistant.

Resilient metal seals often have to perform under extreme service conditions. Standard solutions as found in this catalogue may not always suffice this requirements. Please get in contact with us in case of any questions.

### Plating and Coating

Platings or coatings are applied to improve the sealing performance of metal seals. Depending on the required tightness, the selected seal, the media to be sealed and the condition of the mating surface, a softer or harder plating or coating shall be chosen. When temperature allows, either PTFE coating or soft silver should be applied.

The soft layer, flows at seal compression into the mating surface irregularities and creates hereby the best seal performance possible.

PTFE coating can achieve leak rates around 10<sup>-6</sup> mbar.l/s, measured with the vacuum method.

Metal type plating, like silver, indium, and tin to name a few, can achieve leak rates better than 10<sup>-9</sup> mbar.l/s up to 10<sup>-12</sup> mbar.l/s.

## 6. Compound Selection - Metal C- and O-rings

### Heat Treatment

It is recommended to heat treat all non spring energised metal c- and o-rings. The seals will perform better in the heat treated condition.

Heat treatment of super alloys such as Inconel X750, Inconel 718, Haynes 214, will increase the yield strength of the material. This influences directly the seal performances, because of increasing seating load and a better spring back.

The increased seating load will press the soft plating better into the surface irregularities, thereby creating a better seal.

The higher spring back means that the intimate contact between the seal and the mating surface is maintained longer in case of flange deflection.

Such flange deflection can be a result of high temperatures, high pressures and/or a combination thereof.

Heat treatment is mostly not required for spring energised c-rings and metal o-rings. However some demanding applications in oil and gas environment do require heat treatment to prevent material embrittlement. (Heat treatment according to Nace.)

Annealing and heat treatment also improves the seal's resistance against fatigue under cyclic loads. Structural integrity will be maintained for an extended period of time. Age hardening, annealing and solution and precipitation heat treatment is possible.

Metal o-rings and some spring energised c-rings made from austenitic stainless steels, are not precipitation hardenable. These seals can only be supplied in the work hardened condition. For demanding applications and for temperatures above +400°C, it is advised to use high alloy steels only.

**Heat Treatment Codes for Jacket and Spring Materials**

Material Code	HT-1	HT-2	HT-3	HT-4	HT-5	HT-6	HT-7	HT-8
1 Nickel alloy X-750	X	X		X				
2 Nickel alloy 718	X	X		X	X			
3 321 SS	X							
4 Nickel alloy 600	X		X					
5 304 SS	X							
6 304 SS, high tensile	X							
7 316 SS	X							
8 Hastelloy	X							
9 302 SS	X							
A ELGILLOY	X							X
B HAYNES 214	X						X	
C ALUMINIUM 1050	X		X					
D ALLOY 625	X					X		
E NIMONIC 90	X							
F HASTELLOY C-276	X				X			
G HAYNES 188	X							

- HT-1 Work Hardened
- HT-2 Age Hardened, short cycle
- HT-3 Annealing
- HT-4 Solution and Precipitation Heat treatment
- HT-5 Nace Heat treatment, Hardness max 40 HRC, Alloy 718
- HT-6 Nace Solution Annealing
- HT-7 Stress Relief
- HT-8 Age Hardened, Hardness max for NACE 62 HRC

### 6. Compound Selection - Metal C- and O-rings

#### Types of Metal C- and O-ring Seals

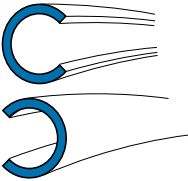
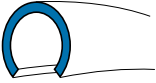
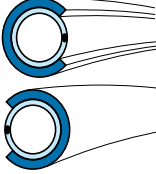
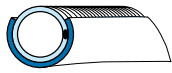
Metal C-rings			
	Code	Description	Features
	CI CE	Metal C-ring Internal (CI) or External (CE) Pressure Face Seal	Designed for high pressure (system pressure energised). They require low bolting load and have good spring back properties
	CA	Metal C-ring, Radial Seal for Axial Pressure	Designed to seal shaft to bore. Close tolerances on both shaft and bore are required.
	CSI CSE	Spring Energised Metal C-ring, Internal (CSI) or External (CSE) Pressure Face Seal	Designed for high pressure and excellent tightness performance (system pressure energised). They require high bolting load and have good spring back properties.
	CSA	Spring Energised Metal C-ring, Radial Seal for Axial Pressure	Designed to seal shaft to bore. Close tolerances on both shaft and bore are required.

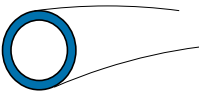
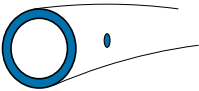
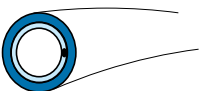
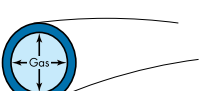
Metal O-rings			
	Code	Description	Features
	OI OE	Metal O-ring Internal (OI) or External (OE) Pressure Face Seal	Designed for lower pressure ranges. Avoids ingress of the working fluid into the seal, Moderate load, moderate pressure capability.
	OVI OVE	Metal O-ring internally (OVI) or externally (OVE) vented Face Seal	Designed for higher pressure. Besides the own seating load the seal is also energised by the system pressure.
	OSI OSE	Metal O-ring externally (OSE) or internally (OSI) spring-energised Face Seal and Radial Seal	Designed for extreme low leakage at moderate pressures.
	OGI OGE	Metal O-ring externally (OGE) or internally (OGI) gas-energised Face Seal	For high temperature and moderate pressure applications.

### 6. Compound Selection - Metal C- and O-rings

#### Load and Spring Back

The selection of the most suitable seal for extreme service conditions is often a delicate trade off between load and spring back of the seal. The compression load or seating load has a direct relation with the obtainable tightness where as the spring back of the seal determines how well this tightness is maintained with varying temperatures and pressures.

For a given seal cross section and seal type it is generally true that with maximum load the spring back is lowest. And of course that seal with minimum load will generate the highest spring back.

Looking at a metal o-ring made from stainless steel, one with a thin wall and the other with a thick wall, the one with the thin wall will require lower load to be compressed to groove depth than the one with the thick wall, where the spring back of the latter will be lower than the one with the thin wall.

Again looking at the same cross section metal o-ring, a seal made from Inconel X750 or Inconel 718 will have a higher load and higher spring back than a similar wall thickness metal o-ring made from stainless steel.

Going over to metal c-rings, there is a certain similarity with spring back and seating load. The big difference is that metal c-rings compared with the same cross section metal o-rings, typically generate a lower load, and thus a better spring back than metal o-rings.

To overcome the low load of metal c-rings, the spring energised metal c-ring was developed. This seal generates a relative high and uniform seating load with a relative high spring back.

#### Compression or Seating Load

The compression or seating load is expressed in N/mm seal circumference. The higher the load, the better the sealing performance will be. Soft plating requires lower load than harder plating.

Rough surface finish of the sealing faces require a higher load to obtain similar seal performance.

Non plated seals typically require extreme high loads to obtain technical tightness. It will be difficult, regardless the applied load to obtain a high tightness with unplated seals.

#### Tightness, Plating

Depending on the required tightness, medium to be sealed and temperature, a different plating or coating may be selected.

For tightness better than 10<sup>-9</sup> mbar.l/s a soft plating is always required. Indium and Tin are soft platings. PTFE is a soft coating too, but the obtainable tightness is limited to 10<sup>-6</sup> mbar.l/s., because of the own porosity of PTFE.

Silver, Gold and Copper are medium soft and require a higher load seal to obtain tightness ranges of 10<sup>-9</sup> mbar.l/s. Silver is the most common used plating. Nickel plating, being the hardest plating requires a high load seal selection.

Plating Code	Plating/Coating
S	Silver – max. 430°C
G	Gold – max. 930°C
C	Copper – max. 930°C
N	Nickel – max. 1200°C
L	Lead – max. 200°C
T	PTFE – max. 290°C
SN	Tin – max. 200°C
IN	Indium – max. 130°C

Thickness Code	Plating Thickness in µm
30	10-30
50	30-50
70	50-70

#### Flange Rotation or Lift Off

Big diameters and high temperatures play a decisive role in the selection of a metal seal. Flange rotation or lift off occurs under high pressure. The higher the pressure and the bigger the flange diameters, subjected to this pressure, the bolts will be subjected to a quite high stress and strain, resulting in flange rotation or lift off.

For such service conditions the biggest possible cross section for the given diameter should be selected, in order to have the best possible spring back characteristics.

#### Summary Seal Design

- The groove surface finish for any selected seal should be equal or better than Ra = 1,8. For tightness equal or better than 10<sup>-9</sup> mbar.l/s, a surface finish better than Ra = 0,8 should be applied.
- Always select the biggest possible cross section for a given diameter.
- Selected the softest plating allowed for the application. If bold load permits, choose the highest seal load available when medium soft plating such as silver, gold or copper is selected.
- For temperatures above 350°C it is advised to use Inconel as base materials.
- For pressures above 35 MPa it is advised to use c-ring type seals or vented o-rings, both with or without spring energising, depending on the required tightness.
- For high temperature applications and when an o-ring type seal is required a gas filled seal may be the better option.



## 6. Compound Selection - Metal C- and O-rings

### Groove and Seal Dimensions – Metal O-rings

Internal Pressure Face Seals (OI, OVI, OGI, OSI)										
Seal Dimensions				Groove Dimensions					Load	SB
AS			MT	DC	DG	GD	WG	R		
Axial Section	Tolerance on AS	Material Code	Material Thickness	Diametrical Clearance	Groove Diam. (range)	Groove Depth (min/max)	Groove Width (min)	Radius (max)	N/mm Circumference*	Spring Back in mm
0,89	+0,08/-0,03	M	0,15	0,20	6,35-25	0,64-0,69	1,40	0,25	140	0,03
1,19	+0,08/-0,03	H	0,20	0,25	10-50	0,94-1,02	1,78	0,30	100	0,03
1,57	+0,08/-0,03	L	0,15	0,28	10-200	1,14-1,27	2,29	0,38	60	0,06
		M	0,25	"	"	"	"	"	140	0,05
		H	0,36	"	"	"	"	"	200	0,04
2,39	+0,08/-0,03	L	0,15	0,33	13-200	1,88-2,01	3,18	0,51	40	0,06
		M	0,25	"	"	"	"	"	100	0,05
		H	0,46	"	"	"	"	"	200	0,04
3,18	+0,08/-0,0	M	0,25	0,43	25-400	2,54-2,67	4,06	0,76	60	0,08
		H	0,51	"	"	"	"	"	180	0,05
3,96	+0,10	M	0,41	0,61	75-650	3,18-3,30	5,08	1,27	90	0,10
		H	0,51	"	"	"	"	"	135	0,08
4,78	+0,13	M	0,51	0,71	100-800	3,84-3,99	6,35	1,27	90	0,14
		H	0,64	"	"	"	"	"	200	0,10
6,35	+0,13	M	0,64	0,76	200-1200	5,05-5,28	8,89	1,52	100	0,20
		H	0,81	"	"	"	"	"	250	0,15
9,53	+0,13	M	0,97	1,02	300-2000	8,26-8,51	12,7	1,52	150	0,25
		H	1,24	"	"	"	"	"	300	0,20
12,70	+0,15	M	1,27	1,27	800-3000	11,05-11,43	16,51	1,52	200	0,30
		H	1,65	"	"	"	"	"	350	0,20

\* Load and spring back figures are based on Inconel X750 in the age hardened condition. 321 stainless steel will only generate 1/3 of the given Inconel figures. Actual load figures and to a lesser extend spring back can differ hugely from the given data. Tolerances on groove depth, plating, diametrical clearance and differences in material batches can create differences of up to 100% for the smaller cross sections, down to 50% for the bigger cross section.

## 6. Compound Selection - Metal C- and O-rings

### Groove and Seal Dimensions – Metal O-rings

**Attention:** Internal pressure seal: Diameter Seal Outside = Reference

**Formula:**  $DSO = DG - DC - (2 \times \text{Plating Thickness})$

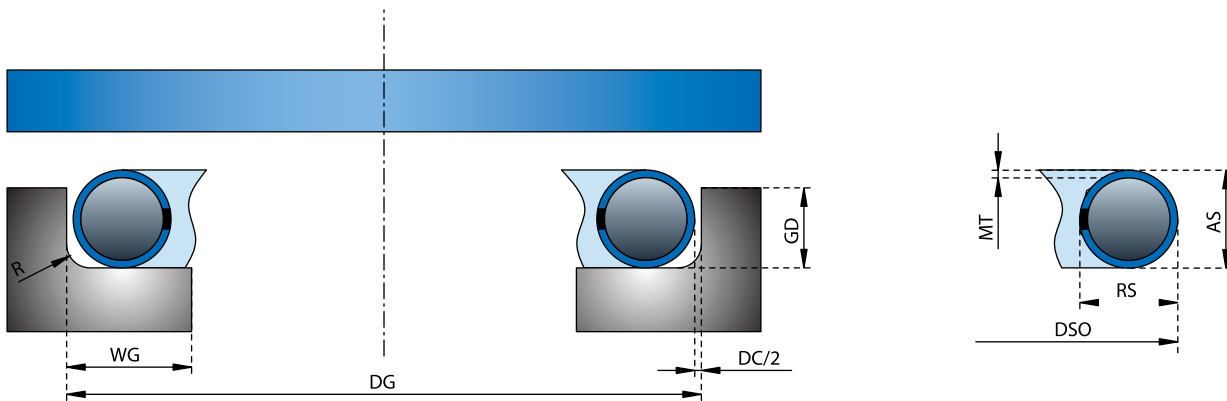

### Standard Materials and Codes

Jacket		Spring	
Code	Material	Code	Material
1	Alloy X-750*	0	None
3	321 SS	1	Alloy X-750*
4	Alloy 600	2	Alloy 718
		9	302 SS

\* X-750 will become obsolete. Other materials on request.

## 6. Compound Selection - Metal C- and O-rings

### Groove and Seal Dimensions – Metal O-rings

External Pressure Face Seals (OE, OVE, OGE, OSE)										
Seal Dimensions				Groove Dimensions					Load	SB
AS			MT	DC	DG	GD	WG	R		
Axial Section	Tolerance on AS	Material Code	Material Thickness	Diametrical Clearance	Groove Diam. (range)	Groove Depth (min/max)	Groove Width (min)	Radius (max)	N/mm Circumference*	Spring Back in mm
0,89	+0,08/-0,03	M	0,15	0,20	6,35-25	0,64-0,69	1,40	0,25	140	0,03
1,19	+0,08/-0,03	H	0,20	0,25	10-50	0,94-1,02	1,78	0,30	100	0,03
1,57	+0,08/-0,03	L	0,15	0,28	10-200	1,14-1,27	2,29	0,38	60	0,06
		M	0,25	"	"	"	"	"	140	0,05
		H	0,36	"	"	"	"	"	200	0,04
2,39	+0,08/-0,03	L	0,15	0,33	13-200	1,88-2,01	3,18	0,51	40	0,06
		M	0,25	"	"	"	"	"	100	0,05
		H	0,46	"	"	"	"	"	200	0,04
3,18	+0,08/-0,03	M	0,25	0,43	25-400	2,54-2,67	4,06	0,76	60	0,08
		H	0,51	"	"	"	"	"	180	0,05
3,96	+0,10	M	0,41	0,61	75-650	3,18-3,30	5,08	1,27	90	0,10
		H	0,51	"	"	"	"	"	135	0,08
4,78	+0,13	M	0,51	0,71	100-800	3,84-3,99	6,35	1,27	95	0,14
		H	0,64	"	"	"	"	"	200	0,10
6,35	+0,13	M	0,81	0,76	200-1200	5,05-5,28	8,89	1,52	100	0,20
		H	0,64	"	"	"	"	"	250	0,15
9,53	+0,13	M	0,97	1,02	300-2000	8,26-8,51	12,70	1,52	150	0,25
		H	1,24	"	"	"	"	"	300	0,20
12,70	+0,15	M	1,27	1,27	800-3000	11,05-11,43	16,51	1,52	200	0,30
		H	1,65	"	"	"	"	"	350	0,20

\* Load and spring back figures are based on Inconel X750 in the age hardened condition. 321 stainless steel will only generate 1/3 of the given Inconel figures. Actual load figures and to a lesser extend spring back can differ hugely from the given data. Tolerances on groove depth, plating, diametrical clearance and differences in material batches can create differences of up to 100% for the smaller cross sections, down to 50% for the bigger cross section.

## 6. Compound Selection - Metal C- and O-rings

### Groove and Seal Dimensions – Metal O-rings

**Attention:** External pressure seal: Diameter Seal Inside = Reference

**Formula:**  $DSI = DG + DC + (2 \times \text{Plating Thickness})$

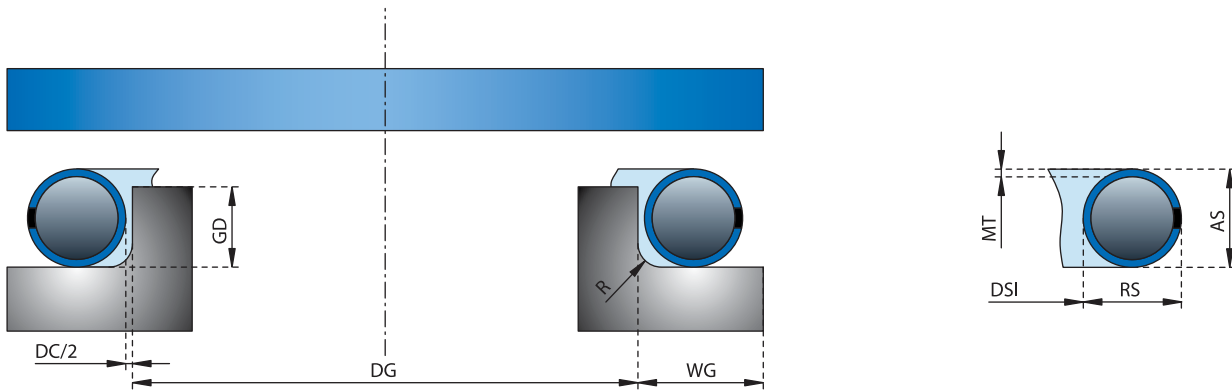

### Standard Materials and Codes

Jacket		Spring	
Code	Material	Code	Material
1	Alloy X-750*	0	None
3	321 SS	1	Alloy X-750*
4	Alloy 600	2	Alloy 718
		9	302 SS

\* X-750 will become obsolete. Other materials on request.

## 6. Compound Selection - Metal C- and O-rings

### Groove and Seal Dimensions – Metal C-rings

Internal Pressure Face Seal (CI)											
Seal Dimensions						Groove Dimensions				Load	SB
AS		RS	Material Code	MT	DC	DG	GD	WG	R		
Axial Section	Tolerance on AS	Radial Section		Material Thickness	Diametrical Clearance	Groove Diameter (range)	Groove Depth (min/max)	Groove Width (min)	Radius (max)	N/mm Circumference*	Spring Back in mm
0,79	+/-0,05	0,71	M	0,15	0,05	6-25	0,64-0,69	1,02	0,25	30	0,04
			H	0,18	"	"	"	"	50	"	
1,19	+/-0,05	0,96	M	0,15	0,07	8-50	0,94-1,02	1,40	0,30	20	0,03
			H	0,2	"	"	"	"	35	"	
1,57	+/-0,05	1,26	M	0,15	0,10	10-200	1,27-1,37	1,91	0,38	10	0,05
			H	0,25	"	"	"	"	40	"	
2,39	+/-0,05	1,91	M	0,25	0,15	13-400	1,91-2,01	2,67	0,51	35	0,04
			H	0,38	"	"	"	"	65	"	
2,79	+/-0,05	2,25	M	0,25	0,15	200-500	2,23-2,31	3,10	0,55	30	0,12
3,18	+/-0,08	2,54	M	0,38	0,20	25-600	2,54-2,67	3,43	0,76	45	0,15
			H	0,51	"	"	"	"	100	0,13	
3,96	+/-0,08	3,17	M	0,41	0,25	32-750	3,18-3,30	4,32	1,27	40	0,20
			H	0,61	"	"	"	"	110	0,17	
4,78	+/-0,10	3,82	M	0,51	0,30	75-900	3,84-3,99	5,08	1,27	65	0,22
			H	0,76	"	"	"	"	150	0,18	
5,60	+/-0,10	4,50	M	0,51	0,30	75-1000	4,48-4,65	5,90	1,27	55	0,22
6,35	+/-0,10	5,08	M	0,64	0,40	100-1200	5,08-5,28	6,6	1,52	75	0,30
			H	0,97	160	"	"	"	"	"	0,27
7,90	+/-0,10	6,32	M	0,64	0,50	100-1500	6,32-6,58	8,22	1,52	65	0,30
9,53	+/-0,10	7,62	M	0,97	0,60	300-2000	7,62-8,03	9,65	1,52	120	0,40
			H	1,27	"	"	"	"	250	0,32	
12,70	+/-0,13	10,16	M	1,27	0,80	600-3000	10,16-10,67	12,7	1,52	150	0,55
			H	1,65	"	"	"	"	250	0,48	

\* Load and spring back figures are based on Inconel X750 in the age hardened condition. Actual load figures and to a lesser extend spring back can differ hugely from the given data. Tolerances on groove depth, plating, diametrical clearance and differences in material batches can create differences of up to 100% for the smaller cross sections, down to 50% for the bigger cross section.

### 6. Compound Selection - Metal C- and O-rings

#### Groove and Seal Dimensions – Metal O-rings

**Attention:** Internal pressure seal: Diameter Seal Inside = Reference

**Formula:**  $DSO = DG - DC - (2 \times \text{Plating Thickness})$

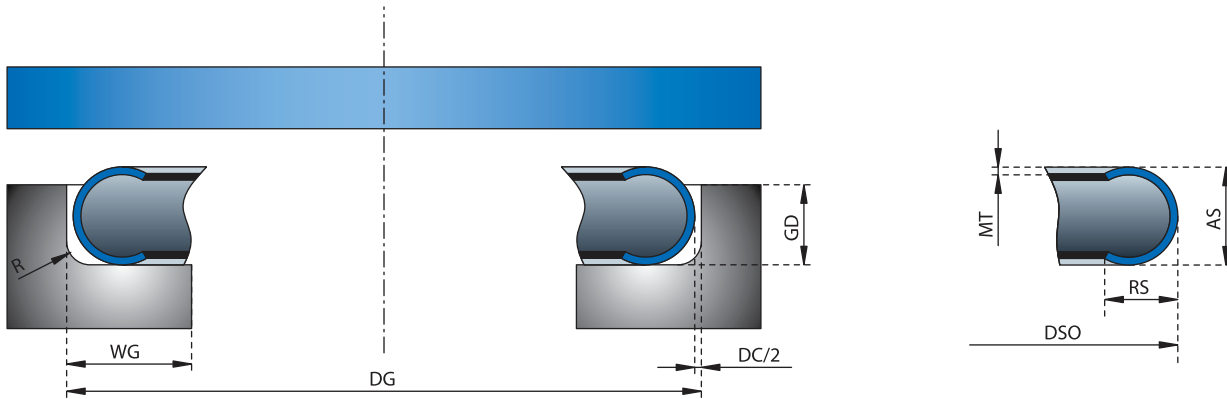

#### Standard Materials and Codes

Jacket		Spring	
Code	Material	Code	Material
1	Alloy X-750*	0	-
2	Alloy 718	0	-
5	304 SS	0	-

\* X-750 will become obsolete. Other materials on request.

## 6. Compound Selection - Metal C- and O-rings

### Groove and Seal Dimensions – Metal C-rings

External Pressure Face Seal (CE)											
Seal Dimensions						Groove Dimensions				Load	SB
AS		RS	Material Code	MT	DC	DG	GD	WG	R		
Axial Section	Tolerance on AS	Radial Section		Material Thickness	Diametrical Clearance	Groove Diameter (range)	Groove Depth (min/max)	Groove Width (min)	Radius (max)	N/mm Circumference*	Spring Back in mm
0,79	+/-0,05	0,71	M	0,15	0,05	6-25	0,64-0,69	1,02	0,25	30	0,04
			H	0,18	"	"	"	"	50	"	
1,19	+/-0,05	0,96	M	0,15	0,07	8-50	0,94-1,02	1,40	0,30	20	0,03
			H	0,20	"	"	"	"	35	"	
1,57	+/-0,05	1,26	M	0,15	0,10	10-200	1,27-1,37	1,91	0,38	10	0,05
			H	0,25	"	"	"	"	40	"	
2,39	+/-0,05	1,91	M	0,25	0,15	13-400	1,91-2,01	2,67	0,51	35	0,04
			H	0,38	"	"	"	"	65	"	
2,79	+/-0,05	2,25	M	0,25	0,15	200-500	2,23-2,31	3,10	0,55	30	0,12
3,18	+/-0,08	2,54	M	0,38	0,20	25-600	2,54-2,67	3,43	0,76	45	0,15
			H	0,51	"	"	"	"	100	0,13	
3,96	+/-0,08	3,17	M	0,41	0,25	32-750	3,18-3,30	4,32	1,27	40	0,20
			H	0,61	"	"	"	"	110	0,17	
4,78	+/-0,10	3,82	M	0,51	0,30	75-900	3,84-3,99	5,08	1,27	65	0,22
			H	0,76	"	"	"	"	150	0,18	
5,60	+/-0,10	4,50	M	0,51	0,30	75-1000	4,48-4,65	5,90	1,27	55	0,22
6,35	+/-0,10	5,08	M	0,64	0,40	100-1200	5,08-5,28	6,6	1,52	75	0,30
			H	0,97	"	"	"	"	160	0,27	
7,90	+/-0,10	6,32	M	0,64	0,50	100-1500	6,32-6,58	8,22	1,52	65	0,30
9,53	+/-0,10	7,62	M	0,97	0,60	300-2000	7,62-8,03	9,65	1,52	120	0,40
			H	1,27	"	"	"	"	250	0,32	
12,70	+/-0,13	10,16	M	1,27	0,80	600-3000	10,16-10,67	12,7	1,52	150	0,55
			H	1,65	"	"	"	"	250	0,48	

\* Load and spring back figures are based on Inconel X750 in the age hardened condition. Actual load figures and to a lesser extend spring back can differ hugely from the given data. Tolerances on groove depth, plating, diametrical clearance and differences in material batches can create differences of up to 100% for the smaller cross sections, down to 50% for the bigger cross section.

### 6. Compound Selection - Metal C- and O-rings

#### Groove and Seal Dimensions – Metal O-rings

**Attention:** Internal pressure seal: Diameter Seal Outside = Reference

**Formula:**  $DSI = DG + DC + (2 \times \text{Plating Thickness})$

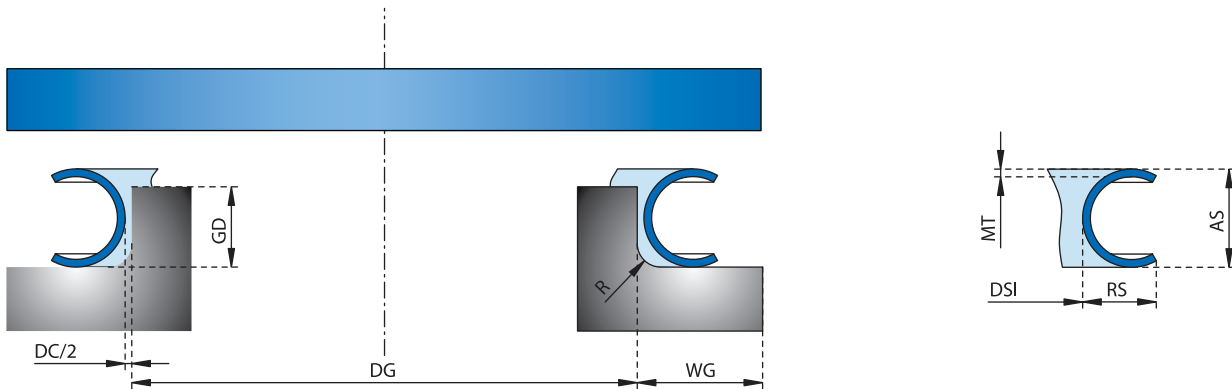

#### Standard Materials and Codes

Jacket		Spring	
Code	Material	Code	Material
1	Alloy X-750*	0	-
2	Alloy 718	0	-
5	304 SS	0	-

\* X-750 will become obsolete. Other materials on request.



### 6. Compound Selection - Metal C- and O-rings

#### Groove and Seal Dimensions – Metal C-rings

#### Spring Energised Internal Pressure Face Seals (CSI)

Seal Dimensions						Groove Dimensions				Load	SB
AS		RS		MT	DC	DG	GD	WG	R		
Axial Section	Tolerance on AS	Radial Section	Material Code	Material Thickness	Diametrical Clearance	Groove Diameter (range)	Groove Depth (min/max)	Groove Width (min)	Radius (max)	N/mm Circumference*	Spring Back in mm
1,57	+/-0,05	1,52	M/H	0,15	0,15	20-280	1,27-1,32	2,05	0,35	200	0,10
2,00	+/-0,05	1,85	M/H	0,25	0,20	20-300	1,60-1,68	2,50	0,40	180	0,12
2,39	+/-0,05	2,24	M/H	0,25	0,20	25-400	1,91-2,01	3,10	0,50	160	0,15
2,79	+/-0,05	2,64	M/H	0,25	0,25	25-500	2,23-2,34	3,60	0,50	200	0,18
3,18	+/-0,08	2,90	M/H	0,38	0,30	25-600	2,54-2,67	4,10	0,75	160	0,20
3,96	+/-0,08	3,60	M/H	0,41	0,41	32-750	3,18-3,30	5,10	1,20	210	0,25
4,78	+/-0,10	4,49	M/H	0,51	0,46	75-900	3,84-3,99	6,20	1,20	250	0,28
5,60	+/-0,10	5,19	M/H	0,51	0,48	75-1000	4,48-4,70	7,30	1,20	200	0,30
6,35	+/-0,10	5,81	M/H	0,64	0,51	100-1800	5,08-5,28	8,30	1,50	340	0,36
7,90	+/-0,10	7,25	M/H	0,64	0,70	150-3000	6,32-6,58	10,40	1,50	300	0,40
9,53	+/-0,10	8,66	M/H	0,97	0,75	300-3000	7,62-8,03	12,40	1,50	430	0,43
12,70	+/-0,13	11,53	M/H	1,27	1,00	600-7600	10,16-10,67	16,50	1,50	500	0,56

\* Load and spring back figures are based on Inconel /Inconel Jacket and spring. Actual load figures and to a lesser extend spring back can differ hugely from the given data. Tolerances on groove depth, plating, diametrical clearance and differences in material batches can create differences of up to 100% for the smaller cross sections, down to 50% for the bigger cross section. Load figures only valid for "M" (medium duty) spring.

**Attention:** Internal pressure seal: Diameter Seal Outside = Reference

**Formula:**  $DSO = DG - DC - (2 \times \text{Plating Thickness})$

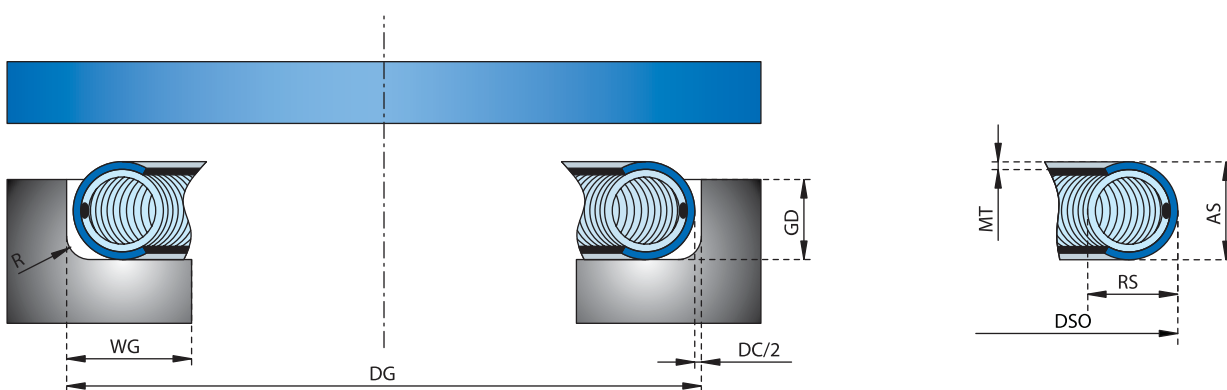

#### Standard Materials and Codes

Jacket		Spring	
Code	Material	Code	Material
1	Alloy X-750*	1	Alloy X-750*
2	Alloy 718	2	Alloy 718
5	304 SS	9	302 SS
-	-	A	Elgiloy
-	-	E	Nimonic

\* X-750 will become obsolete. Other materials on request.

### 6. Compound Selection - Metal C- and O-rings

#### Groove and Seal Dimensions – Metal C-rings

Spring Energised External Pressure Face Seals (CSE)

Seal Dimensions						Groove Dimensions				Load	SB
AS		RS	Material Code	MT	DC	DG	GD	WG	R	N/mm Circumference*	Spring Back in mm
Axial Section	Tolerance on AS	Radial Section		Material Thickness	Diametrical Clearance	Groove Diameter (range)	Groove Depth (min/max)	Groove Width (min)	Radius (max)		
1,57	+/-0,05	1,52	M/H	0,15	0,15	20-280	1,27-1,32	2,05	0,35	200	0,10
2,00	+/-0,05	1,85	M/H	0,25	0,20	20-300	1,60-1,68	2,50	0,40	180	0,12
2,39	+/-0,05	2,24	M/H	0,25	0,20	25-400	1,91-2,01	3,10	0,50	160	0,15
2,79	+/-0,05	2,64	M/H	0,25	0,25	25-500	2,23-2,34	3,60	0,50	200	0,18
3,18	+/-0,08	2,90	M/H	0,38	0,30	25-600	2,54-2,67	4,10	0,75	160	0,20
3,96	+/-0,08	3,60	M/H	0,41	0,41	32-750	3,18-3,30	5,10	1,20	210	0,25
4,78	+/-0,10	4,49	M/H	0,51	0,46	75-900	3,84-3,99	6,20	1,20	250	0,28
5,60	+/-0,10	5,19	M/H	0,51	0,48	75-1000	4,48-4,70	7,30	1,20	200	0,30
6,35	+/-0,10	5,81	M/H	0,64	0,51	100-1800	5,08-5,28	8,30	1,50	340	0,36
7,90	+/-0,10	7,25	M/H	0,64	0,70	150-3000	6,32-6,58	10,40	1,50	300	0,40
9,53	+/-0,10	8,66	M/H	0,97	0,75	300-3000	7,62-8,03	12,40	1,50	430	0,43
12,70	+/-0,13	11,53	M/H	1,27	1,00	600-7600	10,16-10,67	16,50	1,50	500	0,56

\* Load and spring back figures are based on Inconel /Inconel Jacket and spring. Actual load figures and to a lesser extend spring back can differ hugely from the given data. Tolerances on groove depth, plating, diametrical clearance and differences in material batches can create differences of up to 100% for the smaller cross sections, down to 50% for the bigger cross section. Load figures only valid for "M" (medium duty) spring.

**Attention:** Internal pressure seal: Diameter Seal Inside = Reference

**Formula:** DSI = DG + DC + (2 x Plating Thickness)

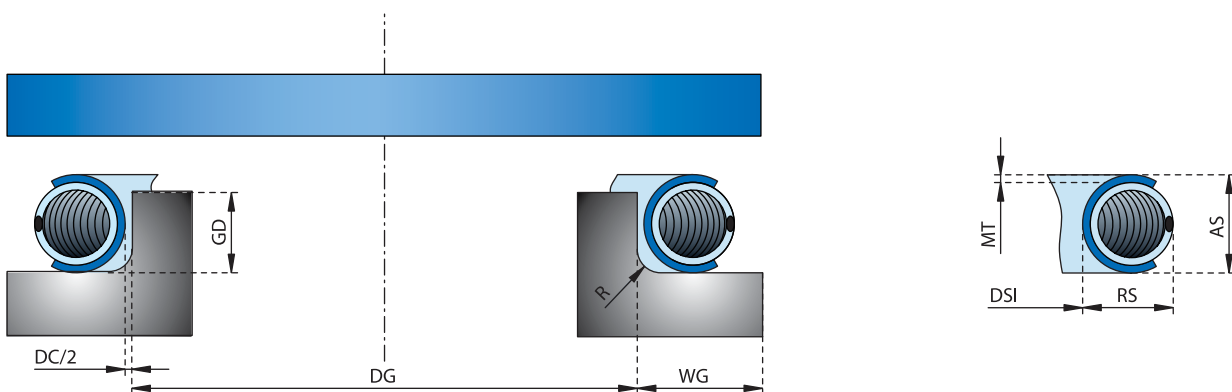

#### Standard Materials and Codes

Jacket		Spring	
Code	Material	Code	Material
1	Alloy X-750*	1	Alloy X-750*
2	Alloy 718	2	Alloy 718
5	304 SS	9	302 SS
-	-	A	Elgiloy
-	-	E	Nimonic

\* X-750 will become obsolete. Other materials on request.

### 6. Compound Selection - Metal C- and O-rings

#### Groove and Seal Dimensions – Metal C-rings

#### Radial Seals for Axial Pressure (CA)

Groove Dimensions							Seal Dimensions					
	BD		SD		WG	R		RS	MT	DSO	DSI	
Bore Diameter (range)	Bore Diameter	Tolerance on BD	Shaft/Rod Diameter	Tolerance on SD	Groove Width (min)	Radius (max)	Material Code	Radial Section	Material	Diameter Seal Outside	Diameter Seal Inside	Tolerance on DSO and DSI
12,70-38,00	SD + 3,12	+0,03	BD - 3,12	-0,03	1,3	0,38	1.57M	1,64	0,15	BD + 0,08	DSO - 3,28	+/-0,03
38,01-45,00	SD + 3,07	+0,03	BD - 3,07	-0,03	1,3	0,38	1.57M	1,64	0,15	BD + 0,10	DSO - 3,28	+/-0,03
30,00-38,00	SD + 4,70	+0,03	BD - 4,70	-0,03	1,98	0,51	2.39M	2,42	0,25	BD + 0,08	DSO - 4,85	+/-0,03
38,01-85,00	SD + 4,65	+0,03	BD - 4,65	-0,03	1,98	0,51	2.39M	2,42	0,25	BD + 0,10	DSO - 4,85	+/-0,03
50,00-85,00	SD + 6,25	+0,03	BD - 6,25	-0,03	2,64	0,76	3.19M	3,22	0,38	BD + 0,10	DSO - 6,45	+/-0,03
85,01-150,00	SD + 6,15	+0,05	BD - 6,15	-0,05	2,64	0,76	3.19M	3,22	0,38	BD + 0,15	DSO - 6,45	+/-0,05
150,01-200,00	SD + 6,05	+0,05	BD - 6,05	-0,05	2,64	0,76	3.19M	3,22	0,38	BD + 0,20	DSO - 6,45	+/-0,05
85,00-150,00	SD + 7,72	+0,05	BD - 7,72	-0,05	3,28	1,27	3.96M	4,01	0,38	BD + 0,15	DSO - 8,09	+/-0,05
150,01-250,00	SD + 7,62	+0,05	BD - 7,62	-0,05	3,28	1,27	3.96M	4,01	0,38	BD + 0,20	DSO - 8,09	+/-0,05
100,00-150,00	SD + 9,32	+0,05	BD - 9,32	-0,05	3,96	1,27	4.78M	4,81	0,51	BD + 0,15	DSO - 9,63	+/-0,05
150,01-300,00	SD + 9,22	+0,05	BD - 9,22	-0,05	3,96	1,27	4.78M	4,81	0,51	BD + 0,20	DSO - 9,63	+/-0,05
150,00-300,00	SD + 12,40	+0,05	BD - 12,40	-0,05	5,28	1,52	6.35M	6,40	0,64	BD + 0,20	DSO - 12,80	+/-0,05

Bore/Shaft concentricity: for bore < 85 mm: 0,015 mm. For bore >85 mm: 0,03 mm.  
Leading edge, shaft and bore side required.

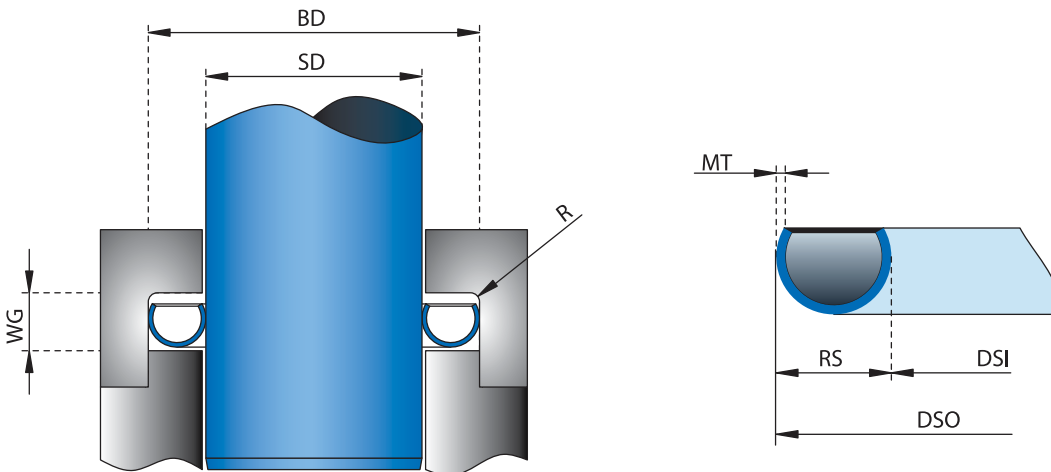

**Attention:** Axial pressure seal: Diameter Seal Outside = Reference

The seal diameter is always the outside diameter without plating.  
Select the desired cross section in relation with the bore diameter.

- Starting from the shaft size 80,70 the DSO (diameter seal outside) equals shaft size 80,70 + 6,45 DSO = 87,15.
- Starting from the bore diameter 87,00 the DSO (diameter seal outside) equals bore size 87,00 + 0,15 DSO = 87,15.
- Plating thickness on radial seals should be limited to 50 microns. Seal diameters remain unchanged for plated seals.

#### Standard Materials and Codes

Jacket		Spring	
Code	Material	Code	Material
1	Alloy X-750*	1	Alloy X-750*
2	Alloy 718	2	Alloy 718
5	304 SS	9	302 SS
-	-	A	Elgiloy
-	-	E	Nimonic

\* X-750 will become obsolete. Other materials on request.

## 6. Compound Selection - Metal C- and O-rings

### Groove Tolerances for Face Type Seals

The actual as produced seal diameter shall be as close as possible to the groove diameter.

By compressing the seal in the groove, the seal outside diameter for internal pressure seals will try to grow and the seal inside diameter for external pressure will try to shrink.

This phenomena is covered by the DC or diametrical clearance. The DC will give allowance for this increase or decrease of the seal diameter.

The seal tolerance and also groove tolerance shall be kept as small as possible. It is better for the seal performance to keep the DC in compressed condition as small as possible.

Ideally, once compressed the seal outer diameter should slightly touch the groove outer diameter or for an external pressure seal the inner seal diameter should slightly touch the groove ID.

**Internal Pressure  
Groove Outer Diameter Tolerances**

Seal Cross Section	O-ring	C-ring	C-ring Spring Energised
0,79	+ 0,05	+ 0,05	-
0,89	+ 0,10	+ 0,05	-
1,19	+ 0,10	+ 0,08	-
1,57	+ 0,10	+ 0,08	-
2,00	-	-	+ 0,10
2,39	+ 0,15	+ 0,10	+ 0,10
3,18	+ 0,15	+ 0,10	+ 0,13
3,96	+ 0,15	+ 0,13	+ 0,15
4,78	+ 0,20	+ 0,15	+ 0,15
5,60	-	+ 0,20	+ 0,20
6,35	+ 0,20	+ 0,20	+ 0,20
7,90	+ 0,20	+ 0,20	+ 0,20
9,53	+ 0,25	+ 0,25	+ 0,25
12,70	+ 0,25	+ 0,25	+ 0,25

**External Pressure  
Groove Inner Diameter Tolerances**

Seal Cross Section	O-ring	C-ring	C-ring Spring Energised
0,79	- 0,05	- 0,05	-
0,89	- 0,10	- 0,05	-
1,19	- 0,10	- 0,08	-
1,57	- 0,10	- 0,08	-
2,00	-	-	- 0,10
2,39	- 0,15	- 0,10	- 0,10
3,18	- 0,15	- 0,10	- 0,13
3,96	- 0,15	- 0,13	- 0,15
4,78	- 0,20	- 0,15	- 0,15
5,60	-	- 0,20	- 0,20
6,35	- 0,20	- 0,20	- 0,20
7,90	- 0,20	- 0,20	- 0,20
9,53	- 0,25	- 0,25	- 0,25
12,70	- 0,25	- 0,25	- 0,25

### 6. Compound Selection - Datasheets

All ERIKS standard and some special O-ring compounds have data sheets with measured values of specific gravity, hardness, tensile strength, elongation at break, compression set, low temperature, and heat ageing in different test circumstances. Any specific data sheet can be obtained upon request.

For several reasons data sheets can sometimes lead to considerable confusion. Manufacturers generally state values measured on test slabs or test buttons. Though these test slabs are made of the same rubber compound as the O-ring, some factors however, are completely different: vulcanisation time, vulcanisation temperature, post-curing time, and size. The vulcanisation time of such a slab can be 20 minutes, whereas the moulding/vulcanisation time of an O-ring - for economical reasons - can only be 2 minutes. Measuring results from a slab will give different values than measuring on an O-ring.

ERIKS has therefore decided that whenever possible most of their data sheets should show values based on measurements made on O-rings. This gives the customer a better picture of the properties to be expected from the O-ring. To put it in other words: the data sheet with values measured on slabs demonstrates what properties the O-ring could have, if produced under the most ideal conditions. ERIKS, however, states the real sealing performance of the O-rings.

This can be illustrated as follows: in most of the data sheets you will find the compression set values measured on slabs of .25 inch. (6 mm) thickness, e.g. 12%. If measured under the same conditions, an O-ring of .139 inch (3.53 mm) will have a value of 19 to 25%. For determining the service life ERIKS has based their measurements on O-rings with a cross section of .139 inch (3.53 mm). The other cross sections have been extrapolated from these values.

These differences also apply to the other values stated. It is therefore very dangerous to compare values of data sheets without knowing the exact testmethod. It is always better to carry out tests on the O-ring itself in the application rather than on a test specimen.



[www.o-ring.info](http://www.o-ring.info)  
for all our data sheets

### 6. Compound Selection

#### O-ring compounds - Field of Application

Most of the preceding parts in this handbook have dealt with selecting the best rubber compound for a given application. Here is information to understand the factors involved in the process and to provide some guidance in selecting the correct material. Only basic compounds are mentioned. A lot of special compounds are available, please ask the local ERIKS division for assistance.

#### Water and Steam Application

Most elastomers can be used for water applications up to 212°F (100°C). Water appears to be an innocuous fluid, people are often surprised to learn that it can bring problems if it is not sealed with the proper O-ring. The mere immersion in water has an adverse effect on the mechanical properties of rubber. After a long period of water immersion, many rubber compounds will swell. In a static application, this may be quite acceptable. Such a seal will not leak. And it can be replaced with a new one after disassembly. An advanced amount of swelling implies a larger volume and consequently more friction. Used as a long term dynamic seal, this gradual swelling of an O-ring in water can cause a slow but very annoying increase in friction. In tests, ethylene propylene rubber has virtually no swell. This material is recommended for O-rings for sealing against water and steam for temperatures up to 150°C (300°F).

#### ERIKS has compounds in:

EPDM PC 55914, HNBR, and AFLAS®.

In FFKM a number of Perfluoroelastomer compounds are available which exhibit perfect sealing properties in steam surroundings. Silicone (VMQ) can also be compounded in such a way that it can be used pressureless in a steam environment up to 250°C (480°F).

#### Note:

When sealing steam or hot water with ethylene propylene, it is important to remember that it will deteriorate when exposed to petroleum lubricants. When lubrication is required, silicone oil, glycerin, or ethylene glycol are suggested. When water changes into steam, the O-ring must maintain an effective seal as the temperature increases. This sometimes causes the rubber to become spongy as a consequence of which all sealing properties are lost. Some compounds, however, are steam resistant.

#### Food Application

Rubber in contact with foods must meet special requirements. There are a number of institutions who regulate the rules and tests. The main institutions are: FDA and NSF in the USA; KTW and BfR in Germany, WRAS in the UK, and KIWA in the Netherlands.

This book primarily discusses the FDA-program because it is the most demanding requirement.

#### Metal Detectable Compounds

Metal detectable seals are the latest advancement used for contamination detection and containment. These compounds can be widely used across a range of industries including Food and Beverage, Pharmaceutical and Dairy with the respective compliances according to FDA and 3A (Class 1). Broken products can be detected and rejected resulting in less product loss. The compounds are detectable by conventional metal detectable products with particle sizes as small as 2mm. So they are able to be used as part of a HACCP process. The temperature range of possible compounds is -60°C to +220°C.



### 6. Compound Selection - FDA



#### FDA Compliancy

##### General information about FDA

For many years ERIKS has had a leading role in the production and marketing of high quality seals. ERIKS has also developed a vast range of elastomeric compounds that are formulated to comply with the regulations issued by the 'United States Food and Drug Administration' (FDA). These regulations are stipulated in Title 21, Chapter 1, subchapter B, section 177.2600 of the 'Federal Food and Cosmetic Act'. These regulations define which rubber polymers and compounding ingredients can be used in rubber articles, intended for repeated contact with food and preventing the use of dangerous substances that might cause cancer.

##### Types of FDA compliancy

Two important types (class 1 and class 2) of FDA compliance exist, depending on the percentage of carbon black that is added to the compound.

Class 1 : for aqueous and greasy media;

Class 2 : for aqueous media.

USP class 6 was especially developed for the pharmaceutical industry. ERIKS offers 5 compounds of this type of USP, all meeting very strict requirements.

#### Certification

ERIKS guarantees 'conformity' by:

- strict production methods,
- an FDA sticker is put on the packaging,
- a certificate of conformity can be obtained with every delivery.



**In general ERIKS guarantees that the FDA materials are 'FDA compliant' which means they are composed with ingredients according the FDA regulations.**

#### Migration tests

Some compounds have been tested by independent laboratories. Rubber articles intended for repeated use in contact with aqueous food shall meet the following specifications: 'The food contact surface of the rubber article in the finished form in which it is to contact food, when extracted with distilled water at reflux 20 milligrams per square inch during the first 7 hours of extraction, not to exceed 1 milligram per square inch during the succeeding 2 hours of extraction'.

Rubber articles intended for repeated use in contact with fatty foods shall meet the following specifications: 'The food-contact surface of the rubber article in the finished form in which it is to contact food, when extracted with n-hexane at reflux temperature, shall yield total extractives not to exceed 175 milligrams per square inch during the first 78 hours of extraction, nor to exceed 4 milligrams per square inch during the succeeding 2 hours of extraction'.

### 6. Compound Selection - FDA - General Compounds



#### Vulc-O-rings FDA class 1

Vulc-O-rings are produced in small quantities. Inside diameter range from 30 mm up to 5.000 mm in the different cross section diameters from 1,78 up to 25 mm.

No chemical additive is added in the bonding of the core ends. Datasheets are available upon request.

Selecting the right elastomer is a balance of material and design.

All ERIKS compounds listed below are produced from listed ingredients. We distinguished the following grades:

#### High Performance O-rings with Certificates

Compound Number	Material ASTM D1418	Colour	Hardness IRHD±5	FDA 177.2600 aqueous & fatty foods	USP Class VI	KTW, DVGW, NSF, WRAS, ACS, W-270, KIWA	3A	EC 1935	ADI free	Temp. resistance °C
329303	Neoprene	black	75	X				X	X	-35/+100
366312 (*)	Nitrile-NBR	blue	60	X			X	X	X	-30/+120
366470	Nitrile-NBR	black	70	X			X	X	X	-30/+120
366302	Nitrile-NBR	black	75	X			X	X	X	-30/+120
366472	Nitrile-NBR	white	75	X				X	X	-30/+120
366480	Nitrile-NBR	black	80	X				X	X	-30/+120
366490	Nitrile-NBR	black	90	X				X	X	-30/+120
886972	HNBR	white	77	X				X	X	-30/+150
886172	HNBR	black	70	X				X		-30/+150
886214 (**)	HNBR	red	69	X				X	X	-30/+150
559260	EPDM	black	60	X				X		-40/+140
559311 (*)	EPDM	blue	67	X			X	X	X	-40/+140
55641	EPDM	black	70	X						-55/+150
559270	EPDM	black	70	X				X	X	-55/+150
559272	EPDM	white	70	X				X	X	-55/+150
559273	EPDM	black	70	X	X		X	X	X	-40/+150
55111	EPDM	black	70	X		X		X	X	-55/+150
559274	EPDM	white	70	X	X			X	X	-40/+150
559302	EPDM	black	70	X	X		X	X	X	-50/+150
559187	EPDM	black	75	X			X	X		-40/+140
559280	EPDM	black	80	X				X	X	-40/+140

(\*): metal detectable compounds

(\*\*): Bio-Hygienic®





### 6. Compound Selection - FDA - General Compounds

#### High Performance O-rings with Certificates

Compound Number	Material ASTM D1418	Colour	Hardness IRHD±5	FDA 177.2600 aqueous & fatty foods	USP Class VI	FDA 177.1550	3A	BfR	EC 1935	ADI free	Temp. resistance °C
514660	FKM	black	60	X					X	X	-15/+200
514670	FKM	black	70	X					X	X	-20/+200
514328	FKM	blue	70	X			X		X	X	-15/+204
514642	FKM	green	70	X					X	X	-20/+200
514672 (*)	FKM	white	70	X					X	X	-15/+200
514674	FKM	blue	70	X					X	X	-20/+200
514002	FKM	green	75	X					X	X	-20/+200
514010	FKM	white	75	X	X		X		X	X	-20/+200
514304	FKM	white	75	X			X		X	X	-20/+200
514172	FKM	black	75	X			X		X	X	-20/+200
514641	FKM	black	75	X					X	X	-20/+200
514682	FKM	white	80	X					X		-15/+200
514683	FKM	black	75	X					X		-15/+200
514312	FKM	black	75	X	X		X		X	X	-20/+204
Genuine Viton® A 514680	FKM	black	80	X					X	X	-20/+200
Teflex® Viton®	FKM/FEP/PFA	black	75	X	X	X			X	X	-20/+200
Genuine Viton® A 514690	FKM	black	90	X					X	X	-20/+200
Genuine Viton® A 514694	FKM	blue	90	X					X	X	-20/+200
Silicone 714742	VMQ	white	40	X					X	X	-60/+200
Silicone 714747	VMQ	transl.	40	X					X	X	-60/+200
Silicone 714748	VMQ	red	40	X					X	X	-60/+200
Silicone 714762	VMQ	white	60	X					X	X	-60/+200
Silicone 714767	VMQ	transl.	60	X	X				X	X	-60/+200
Silicone 714768	VMQ	red	60	X					X	X	-60/+200
Silicone 714217	VMQ	white	60	X	X		X	X	X	X	-60/+200
Silicone 714001	VMQ	transp.	70	X	X			X	X	X	-60/+200
Silicone 714330 (*)	VMQ	blue	69	X			X		X	X	-60/+220
Silicone 714002	VMQ	Transp.	75	X	X			X	X	X	-60/+200
Silicone 714206	VMQ	red	75	X					X	X	-60/+220
Silicone 714006	VMQ	red	75	X			X		X	X	-60/+220
Silicone 714782	VMQ	white	80	X					X	X	-60/+200
Silicone 714787	VMQ	transl.	80	X					X	X	-60/+200
Silicone 714788	VMQ	red	80	X					X	X	-60/+200
Teflex® Silicone	VMQ FEP/PFA	red	70	X	X	X			X	X	-60/+200
Kalrez® 6221	FFKM	white	70	X	X					X	260
Kalrez® 6230	FFKM	black	75	X	X					X	260

(\*): metal detectable compounds



### 6. Compound Selection Kalrez® - FDA

#### O-rings Kalrez® FDA Kalrez® Perfluoroelastomer Parts for Pharmaceutical and Food Handling Applications

Kalrez® parts made from compounds 6221 and 6230 provide superior chemical resistance and low contamination from extractables in pharmaceutical and food handling applications where FDA compliance is required. Compounds 6221 and 6230 are especially suited for Water For Injection (WFI) systems, Steam In Place (SIP) cleaning, and other critical systems.

#### Thermal Stability

Unlike other elastomeric seals made with FDA compliant elastomers, Kalrez® perfluoroelastomer parts are thermally stable up to 260°C, permitting use in applications such as Stage II Sterilization processes, where other elastomers lose their sealing capabilities.

#### Aggressive Water Resistance

In aggressive pharmaceutical and semiconductor processing environments, seal failure from excess swelling, embrittlement, or decomposition can cause unscheduled downtime or product contamination. Elastomeric materials that come in contact with highly pure and aggressive water (e.g. WFI) must be chosen with care in order to prolong seal life. The perfluoroelastomer compounds used in Kalrez® parts have been shown to have extremely low to non-detectable extractable levels in aggressive water systems. Because the perfluoroelastomer polymer in Kalrez® parts is fully saturated, it is also well suited for Ozonated Deionized Water service. Kalrez® parts also exhibit very low swell and loss of mechanical properties after repeated steam cycling.

#### General Chemical Resistance

The overall chemical resistance of EPDM's, silicone elastomers, and fluoroelastomers (FKM) is limited by their respective polymer structures. Kalrez® parts, on the other hand, offer the same universal chemical resistance as PTFE, but unlike PTFE, they have elastomeric properties, which help them maintain their sealing capabilities. Table 1 lists the chemical compatibility of Kalrez® perfluoroelastomer parts and other elastomers used as sealing materials in the pharmaceutical and food handling industries.

Table 1- Elastomer Chemical Compatibility \*

Chemical	Kalrez®	EPDM	VMQ	FKM
Acetic acid	A	A	A	B
Acetone	A	A	C	U
Citric acid	A	A	A	
Hydrogen peroxide	A	B	B	B
Isopropyl alcohol	A	A	A	
Metthyl ethyl ketone	A	A	U	U
Mineral oil	A	U	B	A
NaOH	A	A	B	B
Nitric acid	A	B	B	A
Sodium Hypochlorite	A	B	B	A
Soybean oil	A	C	A	A
Steam (<150°C)	A	A	C	U
Steam (>150°C)	A	C	U	U
Toluene	A	U	U	A
Xylene	A	U	U	A
Maximum Service Temp.	260°C	135°C	200°C	200°C

A = little or no effect ; B = slight swelling and/or loss of physical properties ; C = moderate to severe swelling and/or loss of physical properties/limited functionality ; U = not suitable or recommended.

\* Data has been drawn from DuPont Performance Elastomers tests and industry sources. Data is presented for use only as a general guide and should not be the basis of design decisions. Contact DuPont Performance Elastomers or ERIKS for further information.

Table 2- Typical Physical Properties \* \*

Compound	Kalrez® 6221	Kalrez® 6230
Colour	White	Black
Durometer hardness, Shore A, points±5	70	75
100% Modulus, psi (MPa)	1,050	1,020
Tensile strength at break <sup>(1)</sup> , psi (MPa)	2,200	2,400
Elongation at break <sup>(1)</sup> , %	150	170
Compression set <sup>(2)</sup> , 70h at 160°C	20	18

(1) ASTM D412, (500 mm/min) ; (2) ASTM D395 B, Size 214 O-rings

\*\* Typical physical properties should not be the basis of design decisions.

Contact DuPont Performance Elastomers for further information.

Ask about the special ERIKS brochure on High Purity Seals!

### 6. Compound Selection - FDA

#### O-rings Kalrez® FDA

Kalrez® perfluoroelastomer parts are not routinely tested using the USP testing protocol. Cured samples made only from compounds 6221 and 6230 have been tested in accordance with USP protocols and meet the requirements of a USP Class VI polymer. USP testing was done to support use of Kalrez® parts in pharmaceutical processing and food processing applications. While USP Class VI compliant materials are not required for pharmaceutical and food processing applications, many pharmaceutical and food processing customers, including customers seeking ISO-9000 certification, have requested compliance. Testing of any finished article that incorporates Kalrez® perfluoroelastomer parts is the responsibility of the manufacturer or seller of the finished article if certification that meets USP standards is required.

#### Note:

Please contact ERIKS engineers for determining the right Kalrez® O-ring for an application

#### Medical use

Caution: Do not use Kalrez® perfluoroelastomer parts in medical applications involving implantation in the human body or contact with internal body fluids or tissues. For other medical applications, see DuPont Performance Elastomers Medical Applications Policy, H-69237. DuPont Performance Elastomers will not sell or support products for implantation in the human body or contact with internal body fluids or tissues. DuPont Performance Elastomers makes no representation, promise, express warranty or implied warranty concerning the suitability of these materials for use in implantation in the human body or in contact with internal body fluids or tissues. The content of DuPont Performance Elastomers materials is not certified for implantats.

#### FDA and USP compliancy

The U.S. Food and Drug Administration (FDA) confirmed the compliance of Kalrez® 6221 and 6230 for repeated use in contact with food by Food Contact Notification (FCN) 000101. FCN 000101 was established through the FDA

Premarket Notification Process for food contact substances as described in section 409(h) of the Federal Food, Drug, and Cosmetic Act (21U.S.C. 348(h)) and is the primary method by which the FDA authorizes the use of food additives that are food contact substances. FCN 000101 requires materials to have extractable levels less than 0.2 mg/in<sup>2</sup>. Kalrez® 6221 and 6230 have also been tested in accordance with United States Pharmacopeia Class VI (USP Class VI) and met those requirements.

#### Proven suitability for food and pharma processing

DuPont Performance Elastomers welcomes the new legislation as an opportunity to reaffirm the suitability of Kalrez® 6221 and 6230 perfluoroelastomer parts for repeat use food contact applications. The FCN requires Kalrez® 6221 and 6230 to meet extractable levels not to exceed 0.2 milligrams per square inch. This provides further confirmation of the low risk of contamination from Kalrez® parts and the long term sealing solution for challenging food and pharmaceutical applications.

#### Statement of Compliance

Kalrez® parts made from compounds 6221 and 6230 meet the extractive requirements of 21 CFR 177.2600(E) and may be used for repeated use in compliance with the Food, Drug and Cosmetics Act and all applicable food additive regulations. Kalrez® parts made from compounds 6221 and 6230 have been tested in accordance with the United States Pharmacopeia Class VI (USP Class VI) testing protocol. Testing using the protocols cited above was performed by an external testing facility in compliance with 21 CFR, Part 58 Good Laboratory Practice for Nonclinical Laboratory Studies. 6221 and 6230 offer excellent steam cycling resistance and reduce extractables from sealing materials to trace levels.

**Kalrez® 6221 and 6230 have extractable levels comparable to PTFE**

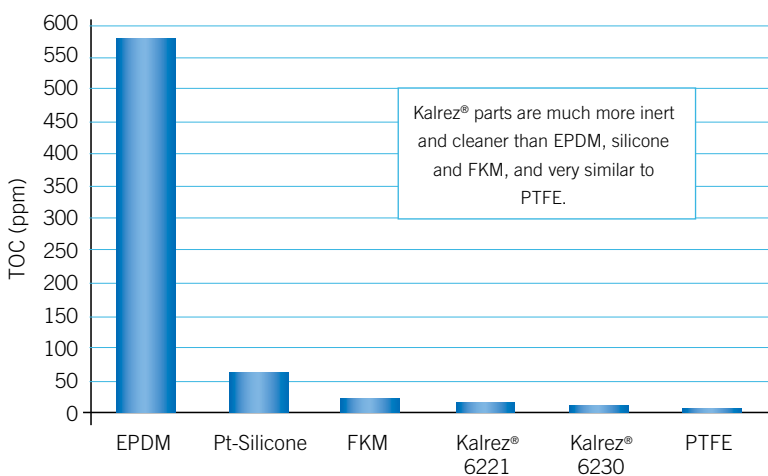

EPA method 415; TOC tests performed on 1" sanitary seals, immersed in 50 ml of sterile WFI at 100°C/24 hrs. The solution was then diluted to 100 ml and analyzed.

### 6. Compound Selection Potable Water - Certification

#### **KTW:**

KTW was adopted as a standard for drinking water. KTW controls the migration of harmful substances. A number of these constituents are subjected to limits. The O-rings are classified under the scope D2.

**See our data sheets gas/water on [www.o-ring.info](http://www.o-ring.info)**

#### **WRAS:**

WRAS controls the harmful constituents in rubber, like metal extraction and micro organisms.

**See our data sheets gas/water on [www.o-ring.info](http://www.o-ring.info)**

#### **NSF:**

**NSF = National Sanitation Foundation. This standard is mainly applied in the USA.**

ERIKS has a number of compounds with NSF compliance.

**See our data sheets gas/water on [www.o-ring.info](http://www.o-ring.info)**

#### **ACS:**

French homologation

#### **DVGW certificates**

ERIKS has several compounds for applications in the gas industry with DVGW-certificates.

The following table lists a summary of the DVGW norms.

We offer materials following DIN EN 549 and DIN EN 682.



### 6. Compound Selection

#### Vacuum Applications

The rate of flow of gases from the pressure side to the vacuum side of an O-ring seal depends to a great extent on how the seal is designed. Increased squeeze by reducing the groove dimensions reduces the leak rate dramatically.

Increased O-ring squeeze reduces permeability by increasing the length of the path the gas has to travel (width of O-ring) and decreasing the area available to the entry of the gas (groove depth). Increased squeeze can be realized with smaller grooves. Increasing squeeze also tends to force the rubber into any small irregularities in the mating metal surface, and thus prevents leakage around the O-ring. Therefore, surfaces against which an O-ring in a vacuum application must seal should have a surface roughness value smoother than usual. Surface finishes of 16 RMS are quite common.

Lubricating the O-ring with a high vacuum grease also reduces the leakage. The vacuum grease aids the seal by filling the microscopic pits and grooves, thus reducing leakage around the O-ring.

Although a very high squeeze is necessary to reduce leakage to an absolute minimum in an O-ring seal, this kind of design may require heavy construction. When a shallow gland is desirable, it must be wide enough to receive the full O-ring volume, also at higher operating temperatures.

The vacuum level denotes the degree of vacuum evidenced by its pressure in torr (or mm. Hg).

Rough vacuum 760 torr to 1 Torr, Medium vacuum 1 torr to  $10^{-3}$  Torr, High vacuum  $10^{-3}$  torr to  $10^{-6}$  Torr, Very high vacuum  $10^{-6}$  torr to  $10^{-9}$  Torr, Ultra high vacuum below  $10^{-9}$  Torr.

For effective vacuum sealing the compound must possess certain properties: low compression set, low permeability to gas, and it should contain few softeners. The best choice is Butyl, but this is very unusual as O-ring compound, followed by a fluoroelastomer.

Extracted plasticizers can leave a film on the instruments.

In static vacuum applications it is recommended to design for a squeeze of the O-ring of at least 25-30% to absorb the irregularities of the metal surface.

It is of great importance that a compound is used with the lowest possible compression set, because temperature fluctuations may impair the sealing properties even further.

ERIKS has compounds that are well suited for vacuum applications:

#### Vacuum Applications

Polymer type	Loss of Weight
Butyl	0,18
CR	0,13
EPDM	0,76
Fluorsilicone	0,28
NBR	1,06
Polyurethane	1,29
Silicon	0,31
FKM	0,07

Loss of weight at  $10^{-6}$  Torr after 2 weeks at 23°C / 73°F.

## 6. Compound Selection

### Degassing

When using O-rings in high vacuum, permeability and degassing of O-rings play an important role and therefore these aspects have to be taken into account. The lower the permeability of the rubber, the easier it is to maintain the vacuum.

Some rubber compounds still contain relatively volatile substances after vulcanisation, which egress from the compound in particular high vacuum applications. Degassing is the loss of volatile elastomeric compounds in vacuum application. This results in some volume loss of the seal material which will lead to seal failure.

The results are:

Vacuum seals are improved by gradual changes to system pressure, the installation of elastomers with greater hardness and higher density, and lowering the system temperature which will result in lower degassing.

For this reason Fluoroelastomers and Perfluorinated elastomers are often used in vacuum applications.

Vacuum applications in combination with service requirements such as high temperature, radiation resistance, and exposure to combinations of fluid media will require careful analysis to select the proper O-ring.

### Contact with plastics

O-rings are more and more being used as a seal in contact with plastics. The problem being faced when the rubber comes in contact with plastics, is the migration of softeners or other "process aids" from the rubber into the plastic. The offending ingredients are usually the ester plasticizers used in some rubber compounds. Additives in the plastic can also migrate into the O-ring, causing substantial change of properties. After the migration of softeners into the plastic, "surface cracking" may arise, resulting in a deterioration of tensile strength. Not all plastics are susceptible to this phenomenon to the same extent. Plastics which are the most susceptible to these softeners are: ABS, Noryl, and Polycarbonate.

Tests have shown that EPDM peroxide cured, FKMs, neoprene, and some silicones are the best choice.

ERIKS also has an EPDM compound 55914PC that will work well.

### High Purity Compounds

In many modern industries high-purity O-rings are used more and more for an optimal progress of the production process. Fluoroelastomer parts are widely used in wet chemical and plasma environments in the fabrication of integrated circuits. Traditional seals often contain carbon black as a reinforcing filler. Many speciality fluoroelastomer compounds contain inorganic or metallic fillers to achieve improved seal performance in aggressive environments. Use of these metal fillers, while beneficial to seal life, can increase particle generation and extractable contaminants.

O-rings made with high purity fluoroelastomers and perfluoroelastomers are designed to meet the demanding contamination needs of the semiconductor industry. From applications in lithography to etching and cleaning, O-rings manufactured with high purity fluoroelastomers offer unmatched extractable contamination performance versus traditional fluoroelastomer O-rings.

Thanks to specific production, compounding, inspection, and ambient factors, several levels of purity are available.

**Consult our website for actual information:**

**[www.o-ring.info](http://www.o-ring.info)**

### Note:

- Clean Room packaging on demand
- ERIKS can deliver high-purity compounds in silicone, Viton®, and Kalrez® for the semicon industry.

### 6. Compound Selection

#### Permeability / Contact with Gases

All rubber compounds are more or less permeable to gas. The rate of permeability to gas of the various compounds varies. Permeability is the tendency of a gas to pass or diffuse through the elastomer. This should not be confused with leakage, which is the tendency of a medium to go around the seal. All elastomers are permeable to some extent allowing air or other gases under pressure or volatile liquids, to penetrate into the seal material and gradually escape on the low pressure side. Permeability may be of prime importance in vacuum service and some pneumatic applications. Permeability is increased as temperatures rise and is decreased by compression of the sealing material. The permeability rate of various gases through different rubber materials varies in an unpredictable way. Even the same basic compounds show large differences. Several gases give different values for the same compound. Permeability is also affected by application parameters such as cross section, pressure, and temperature. It is typical that harder compounds, generally containing more carbon black, exhibit better values. When using NBR a higher ACN percentage is more advantageous.

Laboratory tests have demonstrated that permeability of lubricated O-rings is lower than dry O-rings. These test also show that more strongly squeezed O-rings show lower permeability. In fact, the permeability of a given base polymer will vary according to the proportions of the copolymer. The best choices are Butyl, Fluoroelastomer (FKM 51414), and Nitrile with a high percentage of ACN. Butyl is very unusual as an O-ring compound.

The following list indicates other compounds ranging from the lowest permeability to the highest:

- AU: Polyurethane
- NBR: Nitrile
- FKM: Fluorocarbons
- FFKM: Perfluorinated Elastomers
- EPDM: Ethylene Propylene
- SBR: Styrene/Butadiène
- NR : Natural Rubber

Silicone and Fluorosilicones have even higher gas permeability. Ask for information about gas permeability rates of other ERIKS compounds.

#### Gas permeability

The following table gives the gas permeability coefficient for different media and compounds:

Gas permeability								
Gas permeability coefficient 10 <sup>-17</sup> m <sup>2</sup> / (s x Pa)	IIR	AU	NBR (38% ACN)	NBR (33% ACN)	NBR (28% ACN)	CR	NR	VMQ
Air 60°C / 140°F	2,0	2,5	2,5	3,5	7,5	6,0	25,0	330
Air 80°C / 175°F	5,0	7,0	5,5	7,0	21,0	12,0	40,0	410
Nitrogen 60°C / 140°F	1,5	2,5	1,0	2,0	4,0	4,5	18,0	280
Nitrogen 80°C / 175°F	3,5	5,5	2,5	5,5	7,0	8,0	33,0	360
CO <sub>2</sub> 60°C / 140°F	13	26	30	56	58	58	160	950
CO <sub>2</sub> 80°C / 175°F	29	73	48	63	97	71	210	1500

### 6. Compound Selection

#### High Pressure Gases / Explosive Decompression

In high pressure applications above 1500 psi (100 bar), gases tend to fill the microscopic small pores in the rubber. When using O-rings in high gas (or volatile liquid) pressures or sudden pressure drops, the permeability of elastomers has to be considered.

If gas under high pressure has the opportunity to penetrate to a sufficient degree into the elastomer, this penetrated gas (or volatile liquid) will expand when a sudden pressure drop occurs and will want to leave the elastomer. The greater the pressure, the larger the amount of gas forced into the rubber. When the pressure suddenly drops, the gas expands in the O-ring and will find its way into the atmosphere. The gas may escape harmlessly into the atmosphere, or it may form blisters on the surface. Small cracks deep into the O-ring will consequently develop. Some of these may rupture, leaving cracks or pits and will damage the seal. This phenomenon is called Explosive Decompression.

Generally it is assumed that this phenomenon can occur in cases of pressure drops greater than approx. 400 psi (ca. 30 bar or 3 MPa.). Variables to consider are the gas, pressure, temperature, and the rubber compound. Generally carbon dioxide (CO<sub>2</sub>) causes more problems than nitrogen does. Improvement can be realized in gradual reduction of the pressure and use of rubber with a higher hardness and a higher density. Resistance can be improved by increasing hardness up to 90-95 Shore A. Another method is to decrease the cross section of the O-ring, though this method is not always successful. Nitrile and Fluoroelastomer are the best standard materials for this application.

#### ERIKS has compounds in:

Aflas® for applications with gas and steam.  
FKM 514162 in 94 IRHD, special for oil and gas industry.  
Only by using highly selected rubber compounds and by carefully mixing all ingredients, an "explosive decompression resistant" material can be achieved. Naturally all these compounds are also extrusion resistant.

#### Offshore Applications

In offshore conditions O-rings are exposed to extreme pressures, temperatures, and aggressive media.  
The critical circumstances become even greater by very aggressive oil additives, varying temperatures, gap extrusion, and explosive decompression. Under such conditions only special compounds will be acceptable.  
ERIKS compounds:  
NBR-95, extremely extrusion resistant, tested by the American Petroleum Institute.

AFLAS-90, High molecular Aflas® with increased extrusion resistance and very good compression set. Ideally suited for applications with amines and strong lyes. Can be used up to 200°C (390°F).

HNBR-XNBR 90, a blend of HNBR and XNBR 90 IRHD, ensuring an extreme wear resistance combined with a very high extrusion resistance. Can be used to 150°C (300°F). Also available in 80 IRHD.

#### Compatibility of elastomers with Mineral Based Oils

A well known rapid method for material selection for O-ring applications in mineral oils is the selection based on the aniline point of the oil. The ASTM D 471 test reference oils cover a range of aniline points found in lubricating oils.  
Test Oil ASTM No.1, has a high aniline point 124°C (225°F) and causes slight swelling;  
Test Oil IRM 902, has a medium aniline point 93°C (200°F) and causes intermediate swelling;  
Test Oil IRM 903, has a low aniline point 70°C (157°F) and causes high or extreme swelling of O-ring compounds.

Note: The aniline point of a petroleum oil appears to characterize the swelling action of that oil on rubber vulcanisates. In general, the lower the aniline point, the more severe the swelling action caused by the oil. In static O-ring applications, 20% volume swell may be acceptable, in dynamic applications volume swell may need to be less than 10%.

Any other commercial oil with the same or similar aniline point can be expected to have a similar effect on a O-ring as the corresponding ASTM test oil. However, it has been found that the aniline point method is not always reliable. Some commercial oils, having the same aniline point, can differ significantly because they contain different additives. **It is recommended to conduct compatibility tests on materials in question in the oil that will be used in the application.**

B-test fluids make an extraction of the low molecular softeners of the rubber compound. The more softeners in a compound the more an O-ring hardens and shrinks in an application. Shrinking in O-ring applications is not acceptable. Leakage can be the result.

A popular B-test fluid is a mixture of 42.25% toluene, 25.35% iso-octane, 12.7% di-iso- butylene, 4.3% ethanol, 15% methanol and 0.5% of water.



### 6. Compound Selection

#### Mineral Oils, Hydraulic Fluids

These oils are most frequently used in industry. Their greatest disadvantage is their toxic character and incombustibility. These products are not exactly defined, but they are a mixture of various hydrocarbons. The following guidelines can be given for the several kinds of rubber.

General: Almost all hydraulic fluids contain active additives which can attack the elastomers, certainly at high temperatures. NBR is the workhorse of these fluids. The higher the ACN content in the NBR, the better the resistance. Standard NBR types tend to harden from 110°C (230°F) and higher when additional cross linkage occurs.

#### ERIKS compounds for hydraulic fluids

- NBR: All types can be used.  
Please request a list of available types.
- HNBR: Can be used up to 150°C (300°F), especially compounds which are peroxide cured.
- Neoprene: Shows strong swelling in paraffin oils, as a result of which there is hardly any demand for this rubber.
- FKM: Can generally be used up to 200°C (400°F). Resists many additives, with the exception of certain amines. These amines may cause the rubber to harden quickly. That is why peroxide cured FKM types (FKM GF type) or FFKM are applied in these cases. Also AFLAS® has excellent resistance at very high pressures.
- Silicone: Silicone O-rings can be applied in highly viscous oils only, but are very sensitive to active additives.
- Fluorosilicone: very good up to 175°C (350°F), can also be used till -60°C (-76°F).
- ACM: Generally good resistance to oils up to 150°C (300°F).
- ECO: Epichlorhydrin has good petroleum oil resistance and a wide temperature range -51°C (-60°F) to +150°C (+300°F).
- Polyurethane: Very high resistance, though very sensitive to hydrolysis.

#### Synthetic Oils, Hydraulic Fluids

These fluids have some advantages over mineral oils.

They exhibit better thermal stability, a wider range of application temperature, and lower volatility. On the other hand, prices are higher. A detailed listing of fluids would be too extensive.

Following are a listing of general rules on fluid resistance:

The polar elastomers like NBR, FKM, ACM, HNBR, ECO, and AU have good resistance.

Resistance to hydraulic fluids cannot always be predicted, because the additives often play the major role in chemical attack. As in most cases these additives are not always known, it is always recommend to perform a test to be certain.

#### HFA and HFB Fluids

These fire resistant oils are more aggressive. Specially formulated NBRs should provide an acceptable level of swelling.

ERIKS has several compounds in NBR.

If a minimum amount of swelling is required, fluorocarbons such as FKM 51414 should be used. The best possible option is the FKM 514075 compound thanks to its minimal compression set. Standard polyurethane is limited to 50°C (122°F) due to its sensitivity to hydrolysis.

#### Vegetable Oils

These are oils made from seeds, fruits, or plants, like olive oil, palm oil, and rape seed oil. They have the advantage of being biodegradable and non-toxic. Because recent advancements in hydraulic fluids have made them biodegradable, hydraulic fluids have become more and more popular.

They have, however, a low temperature resistance 80°C (176°F). Therefore, high temperature resistant elastomers are not necessary.

In most cases NBR will perform well, though NBR compounds containing a lot of plasticizers may sometimes begin to swell. The use of polyurethane is limited, though short-time use will only show little swelling. Degradation will mostly occur, certainly after hydrolysis develops.

EPDM and butyl exhibit good chemical resistance, though swelling may occur up to 40%. They can therefore only be used in static applications.

ERIKS has compounds in NBR 70 36624 (70 IRHD); NBR 90 47702 (90 IRHD); also special NBR compounds for FDA, WRC, and KTW applications.

#### Note:

This information on resistance is for reference only. The end-user is responsible for ensuring compatibility.

### 6. Compound Selection

#### Hydraulic and Transmission Oils and ACN content

High ACN content with a low plasticizer level provides excellent resistance to petroleum oils. Low ACN content with high plasticizer level gives better flexibility at lower temperatures. A peroxide-cure provides the best compression set resistance at elevated temperatures. These properties are important for use in hydraulic applications.

ERIKS has several NBR compounds with high ACN content for the extreme demands of heavy equipment, for automatic transmission fluid (ATF), crude oil, as well as NBR with low ACN content for flexibility at very low temperatures.

#### Silicone Fluids

Silicone fluids are chemically very stable. Referring to fluid compatibility tables, all types of seal elastomers, except silicone rubber, may be used for silicone oils and greases. There are some exceptions; however, silicone fluids have a tendency to remove plasticizers from elastomer compounds, causing them to shrink. The effect is most severe with low viscosity fluids and high temperature applications. Because of this, military nitrile compounds and any other nitriles with a low temperature limit below -40°F (-40°C) should not be used to seal silicone fluids, because low temperature nitriles must contain plasticizers.

Other compounds should be tested before being used to be certain they will not shrink more than one or two percent.

Silicone rubber has a poor chemical compatibility rating in contact with silicone fluids. This is because silicone rubber tends to absorb silicone fluids, resulting in swelling and softening of the O-ring. Occasionally, however, it is desirable to seal a silicone fluid with a silicone rubber O-ring. This combination is generally acceptable if the viscosity of the silicone fluid is 100,000 centistokes or more, and if the maximum temperature will not exceed 150°C (300°F).

#### Summary of the resistance for mineral and biological degradable oils

Mineral oils	Elastomer to use
Type:	
H	NBR, FKM, HNBR, AU
H-L	NBR, FKM, HNBR, AU
H-LP	NBR, FKM, HNBR, AU
H-LPD	NBR, FKM, HNBR, AU
H-V	NBR, FKM, HNBR, AU
Waterbased oils	Elastomer to use
Type:	
HFA (>80% water)	-5° +55°C - NBR, FKM, AU
HFB (40% water)	-5° +60°C - NBR, FKM, AU
HFC (35% water)	-20° + 60°C - NBR
HFD-R	-20° + 150°C - EPDM (aeronotique)
HFD-S	-20° + 150°C - FKM
Biological oils	Elastomer to use
Type:	
HETG	for agriculture up to 80°C: AU, NBR, HNBR
HEPG	for protected waterareas up to: 80°C AU, NBR, ANBR, FKM* +80°C: HNBR, FKM* (*only peroxide cured FKM's)
HEES	up to 80°C: AU, NBR, HNBR, FKM +80°C: HNBR, FKM* (*only peroxide cured FKM's)

## 6. Compound Selection

### Contact with Fuels

Fuels are very complex fluids when considering elastomers. Fuels are a blend of aromatic and aliphatic hydrocarbons with the addition of alcohol. It is always recommended to do tests, though Fluoroelastomer, Epichlorhydrin (ECO) and special NBR compounds are most generally used.

For a survey of the Fluoroelastomer compounds please refer to the general Fluoroelastomer brochure which will be sent upon request.

The UL (Underwriters Laboratories, Inc.) A Not For Profit Organization, sponsored by the American Insurance Association, tests and lists many safe electrical and fire protection devices and equipment for use with hazardous liquids and chemicals. For many years they have tested and reexamined elastomer compounds, as being suitable for use with gasoline, naphta, kerosene, liquified petroleum gases, and fuel oils. UL listed O-ring compounds may be used with assurance for gasoline and LPG stations valves, pumps and metering devices, LPG gas bottles, valves, and other types of equipment requiring reliable seals.

### Fuels for Automobile Engines

There are several automotive fuels on the market; leaded and unleaded gasoline with and without MTBE, each type of which can vary in composition and gasohol content. Gasohol is a mixture of gasoline with 10 to 20 percent alcohol. The alcohol may be either ethyl (also called ethanol or grain alcohol) or methyl (methanol or wood alcohol).

The best rubber compound to use depends not only on the fuel itself, but also on the temperature range anticipated and the type of usage, i.e. whether in a static or a dynamic application. In automotive fuel applications, extremely high temperatures are not anticipated, but in northern climates, temperatures as low as -40°C (-40°F) or even -55°C (-65°F) are sometimes encountered.

Most of the compounds recommended for use in fuel have poor low temperature capability in air, but in a fluid that swells them, low temperature capability improves.

### Fuels for Aviation Systems

Aviation fuel systems are low temperature applications. NBR compounds must have good low temperature flexibility, generally low ACN, and higher plasticizer content. Fluorosilicone is also used in aircraft fuel systems and is resistant down to -80°C (-112°F).

### Extreme Temperatures

When air or other gases must be contained at temperatures below -55°C (-65°F), the recommended low temperature limit for most silicone rubbers, special compounds must be used. If the permeability rate of silicone rubbers is too high for the application, bear in mind that the rate decreases as temperature goes down, then an alternative compound must be selected. For applications requiring moderately high temperatures as well as low, it is feasible to use two O-rings, a silicone rubber O-ring to maintain the seal at low temperature plus a fluorocarbon to reduce permeability when the seal is warmer. If a low temperature O-ring must have resistance to a fluid that attacks silicone rubber, then an O-ring in fluorsilicone rubber is recommended. This material has excellent resistance to a wide range of fluids, is usable up to 177°C (350°F) or higher in many applications, and will often seal at temperatures as low as -73°C (-100°F).

Other compounds will often seal at temperatures below their normal low temperature limit by increasing the squeeze. This procedure, however, is generally limited to static face type designs. A heavy squeeze makes a radial seal difficult to assemble.

### 6. Compound Selection

#### Extremely High Temperatures

Extremely high temperatures cause physical and/or chemical attack which may lead to seal failure. Due to extreme heat energy the O-ring will start swelling in the groove, which increases friction at dynamic applications. In many cases the O-ring hardens considerably and the compression set value is different than at lower temperatures. At high temperatures thermoplastic materials may even start flowing so that leakage occurs.

Best choice: a series of special compounds have been developed to provide optimal sealing performance under these conditions. These compounds are: AFLAS®, Fluoroelastomers, Perfluoroelastomers, Silicone, or Fluorosilicone. PTFE, as a thermoplastic material, can be the best choice if elasticity is not required. Perfluoroelastomers can withstand continuous temperatures of 326°C (620°F). Standard compounds NBR and EPDM can be formulated such that a better temperature resistance is achieved. For example, the ERIKS EPDM PC 55914 provides an exceptionally high temperature resistance for EP-type elastomers.

Certain fluoropolymers degrade above 300°C and may release harmful gases if the temperature continues to rise. Please also note that high temperatures will noticeably deteriorate many properties of the compound: permeability to gas, tensile strength, and compression set.

#### ERIKS has compounds:

- up to 200°C (390°F) all fluoropolymers FKM, Teflex-FKM, Teflex-Silicon;
- up to 220°C (430°F) FFKM, Silicone 714177, Fluorosilicones FS 60, FS 70, FS 75, FS 80;
- up to 280°C (540°F) FFKM and special Silicone compounds;
- up to 327°C (620°F) FFKM.

Please be also aware that the temperature resistance greatly depends on the sealing time and chemical environment. Consult ERIKS for assistance in selecting other compounds or consult the material data sheets.

#### Extremely Low Temperatures

Low temperatures reduce molecular activity causing elastomeric compounds to appear harder. At extreme low temperatures elastomers achieve a glass like state and become very brittle, but may still seal and often resume their normal flexibility without harm when warmed. This condition is reversible as temperatures rise. The temperature at which this glass like state occurs can be determined by testing.

The standards for this testing are recorded in ISO 812, ASTM D2137, BS 90 part 25, and ASTM D746.

Extreme cold makes the O-ring shrink in the groove which causes the seal to contract which may cause the seal to leak. If the temperature falls even further, the O-ring will continue to shrink and become brittle - it will be able to be broken upon impact.

The best choice may be Silicone which remains flexible in temperatures down to -50°C (-58°F). Please note that silicone has a very poor chemical resistance and a high permeability to gas. Fluorosilicone is the solution when fuels or oils are involved. It is generally used in aircraft fuel systems and is resistant down to -80°C (-112°F).

PTFE can be used to -170°C (-275°F) but does not have any elasticity properties. It will also start flowing under pressure very quickly (cold flow). PTFE with fillers can reduce this problem noticeably. The metal spring-loaded seal can be useful. Spring-loaded PTFE seals will provide good sealing performance under these conditions. Please ask for the ERIKS technical brochures. Also Teflex, FEP encapsulated

O-rings combine a low temperature resistance (Silicone) with a very good chemical resistance. The low temperature resistance can also be increased by applying more squeeze on the O-ring. This can of course only be done when using static seals.

#### ERIKS has compounds in:

- FKM and NBR to -40°C (-40°F);
- EPDM 55914 and EPDM 55914 PC to -50°C (-56°F);
- Silicone 714177 to -60°C (-76°F);
- Special Fluorosilicone for low temperatures to -90°C (-130°F);
- Metal spring activated FEP O-ring to -200°C (-325°F)

The TR-10 value is a good indicator of the low temperature limit of a dynamic seal or a static seal exposed to pulsating pressure. In a static steady pressure application, an O-ring will generally function to a temperature approximately 8°C or (15°F) lower than the TR-10 temperature. Please note that the TR-10 minimum temperatures as mentioned in the ERIKS data sheets are test values only. Experience has taught that the service temperature is about 10°C (18°F) lower than the TR-10 values indicated.

#### Note:

See also page 39 for Viton® information.

### 6. Compound Selection

#### Coefficient of Friction

Friction causes wear, and seals do not form an exception to this rule. The level of wear is determined by 4 factors: lubricating properties of the medium, surface roughness of the metal, pressure and temperature, and the characteristics of the elastomer.

Generally, breakout friction is many times greater than running friction, but this varies with several factors, primarily the hardness of the O-ring. When only the hardness is changed, an increase will raise breakout friction and a decrease will lower breakout friction.

For special applications where external lubrication is impossible there are several compounds having self-contained lubricants.

This internal lubrication is the incorporation of a friction reducing ingredient into the rubber formula. Since this changes the formula, internally lubricated materials are assigned special compound numbers. Internal lubricants may be such materials as graphite, molybdenum disulfide, powdered PTFE or, more commonly, an organic lubricant. This lubricant migrates through the O-ring and gradually congregates on the surface.

There also exist processes which can modify the surface of an NBR O-ring. The coefficient of friction decreases by up to 50%. The surface is not faced to ensure that all rubber properties are kept. This procedure is also very eco-friendly and can also be applied for drinking water applications.

The so-called AF treatment for Viton®, EPDM, and silicone provides a surface oxidation which builds up an oily film on the rubber. Here too, when the rubber comes in contact with oil, the coefficient of friction can be reduced up to 50%.

#### Abrasion and Wear Resistance

Abrasion resistance is a general term which indicates the relative wear of a compound. It concerns scraping or rubbing of the O-ring surface and is therefore of importance for O-rings used as dynamic seals. This is a very complex problem and cannot be deeply discussed in this edition. Please consult the local ERIKS representative.

The ideal contact surfaces should be 8 to 16 RMS without longitudinal or circumferential scratches.

Best surfaces are honed, burnished, or hard chromeplated. Finishes of dynamic contacting surfaces have a lot to do with the life of the O-ring seals. Appropriate surface finishes are important. Limits of maximum roughness for glands are given because rougher finishes will cause excessive wear. Finer finishes reduce lubrication to the O-ring and may result in stick slipping and irregular wear. Surface roughness values less than 5 micro inches ( $R_a = 0,15 \mu\text{m}$ ) are not recommended for dynamic O-ring seals. The surface must be rough enough to hold small amounts of oil. Finishes below 5 RMS wipe too clean for good moving seal life.

Only some of the elastomers are recommended for O-ring service where moving parts actually contact the O-ring. It is of interest that harder compounds, up to 85 IRHD, are normally more resistant to abrasion than softer compounds. Of course, abrasion resistance must be considered in the light of other requirements such as surface finish and lubrication. The best wear resistance is offered by PUR (Polyurethane) and special XNBR compounds which have proved their value in the offshore world.

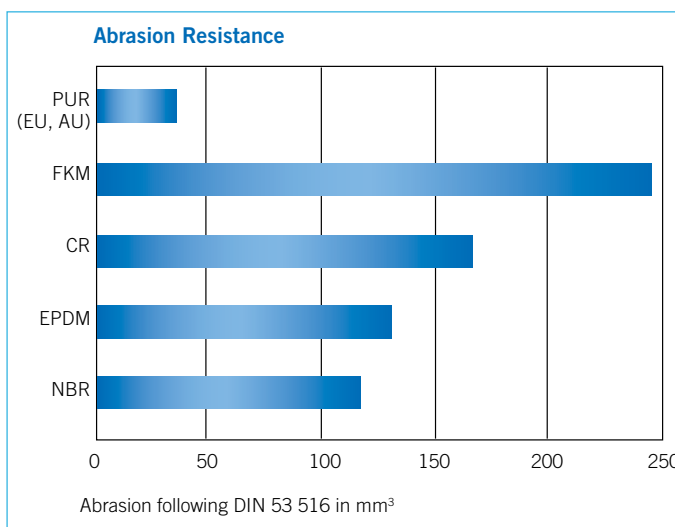

### 6. Compound Selection

#### Contact with Ozone

Ozone is becoming an increasingly inconvenient factor when using O-rings. The large concentrations which develop in summer deteriorate certain elastomers very quickly. Many elastomers like Viton®, silicone, neoprene and EPDM are very suitable for high ozone concentrations. However NBR, the elastomer most commonly being used, is highly sensitive to ozone. At limited concentrations of 50 ppm, little cracks, perpendicular to the direction of stretch, occur in NBR seals. There are a number of possibilities to prevent this:

- Use Viton® because of broad stockrange.
- Use HNBR.
- Use a compound such as NBR/PVC. The lower compression set of NBR/PVC versus NBR should, however, be taken into account.
- Use neoprene CR 32906.
- Use different compounds, (mostly at higher prices e.g. FKM).
- Use ozone resistant NBR.
- Use white compounds for high ozone.

#### Radiation

One of the most important properties of an elastomer, used as an O-ring, is its resistance to compression set. With exposure to gamma radiation, the compression set is most severely effected (of radiation types, gamma radiation has the worst effect on elastomeric materials). After experiencing 108 rads, all elastomers will take over 85% compression set, enough loss of memory that leakage can be expected. At 107 rads, there are big differences between compounds, while at 106 rads, the effects on all compounds are minor.

Therefore in the range of 107 rads an O-ring compound must be selected with care, while at higher levels they should not be considered. At lower levels, factors other than radiation will be more significant. It is therefore important to test a seal in conditions similar to those it will encounter in service. Ask Eriks for data on radiation resistance of O-ring compounds.

#### Electrical Conductivity / Shielding

Elastomers can range from electrically insulating to conductive. This particularly depends on the additives which are added to the elastomers. Specifically:

- insulating: more than  $10^9$  Ohm x cm (almost all rubbers)
- limited conductivity:  $10^5$  to  $10^9$  Ohm x cm (neoprene)
- conductive: lower than  $10^5$  Ohm x cm (special compounds)

It is often essential to shield electronic devices from electromagnetic interference (EMI) to prevent electromagnetic energy from escaping or to ground electronic devices. Conductive elastomers have been developed to provide hermetic sealing in combination with shielding and grounding. These materials can be fabricated into O-rings, Quad-Rings®/X-Rings, molded shapes, sheet stock and die-cuts.

#### Electrical Properties

Polymer	Specific Resistance (Ohm)		Resistivity	
	from	up to	from	up to
NBR	$10^4$	$10^{10}$	15	17
FKM	$10^{10}$	$10^{14}$	20	35
MVQ	$10^{15}$	$10^{16}$	20	40
EPDM	$10^6$	$10^{16}$	10	25
CR	$10^2$	$10^{13}$	5	15
FFKM	$10^{17}$	$5 \times 10^{17}$	16	18
MVQ	0,002	5	-	-
MFQ	0,004	0,1	-	-
EPDM	0,006	10	-	-
FKM	0,006	0,006	-	-

### 6. Compound Selection

#### Colored O-rings

Color compounds offer identification for positive assembly and traceability during and after service. Generally O-rings are black (except silicone), because most of them are filled with carbon black. Carbon black gives the best mechanical sealing properties. In certain cases, however, white additives, like titanium dioxide, can also be used. Green and brown are often used for Viton®, and for silicone red, iron oxide is generally known. In principle any color can be manufactured subject to sufficient quantities ordered.

Presently also fully transparent silicone O-rings can be made. O-rings can also be identified by applying a colored dot on the surface which may ease in differentiating products.

A colored dot can also be applied during the vulcanization process. This dot cannot be removed. The dot is of the same quality as the O-ring and no negative reactions will occur.

Another technique to recognize the rubber material is used by certain FKM Viton® O-rings. By adding a special substance, a tracer, the O-ring will be fluorescent under UV-light which makes identification of the O-ring easier.



#### O-rings in drive belt applications

O-rings are frequently used for drive belts in relatively low power applications on audio visual equipment.

O-rings are designed to maintain a seal while being compressed, whereas a drive belt must maintain its shape and dimensions against a constant stretching load. Therefore, the material of the O-ring used for a drive belt must provide resistance in a number of areas:

- Resistance to creep, the tendency of rubber to slowly stretch or relax.
- Resistance to severe flex, common at high rotational speed.
- Resistance to the abrasion that occurs as the belt travels over the pulleys and sprockets at high speed.

Critical environmental factors may include the presence of ozone, extreme operating temperatures, and other factors.

For optimum results the following are recommended:

- Limit the O-ring stretch to 10-15% of the outside diameter.
- Semi-circular grooves should be half rounded and have a radius equal to the O-ring cross section.
- The diameter of the sheave should be larger than 4 times the O-ring cross section.
- Abrasion resistance is important.

Most O-rings used in drive belt applications are made from Ethylene Propylene or Polyurethane. Polyurethane can exhibit good service life when stretched 20-25%. Depending on the application various elastomeric compounds may also be used effectively. Please contact an ERIKS representative for additional information.

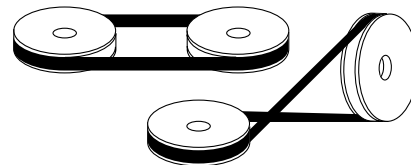

### 6. Compound Selection

#### Linear Expansions

Elastomers have different expansion rates than plastics or steel. So the design of the grooves have to be adapted to that.

#### Thermal Expansion

Material	Thermal Stability	$\times 10^{-5} / ^\circ\text{C}$
FKM	200°C / 392°F	16
NBR	120°C / 250°F	23
VMQ	230°C / 450°F	59-79
FFKM	300°C / 570°F	23
EPDM	150°C / 300°F	16
Stainless	-	1.04
Aluminium	-	1.3
TEFLON	230°C / 450°F	5-8
KEL-F	280°C / 540°F	4-7
Polyimide	275°C / 530°F	5

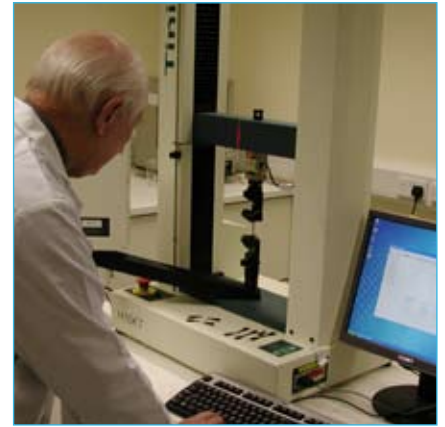

#### Gas Permeability

The following table gives the gas permeability coefficient for different media and compounds.

#### Gas permeability

Gas permeability coefficient $10^{-17} \text{ m}^2 / (\text{s} \times \text{Pa})$	IIR	AU	NBR (38% ACN)	NBR (33% ACN)	NBR (28% ACN)	CR	NR	VMQ
Air 60°C / 14°F	2,0	2,5	2,5	3,5	7,5	6,0	25,0	330
Air 80°C / 175°F	5,0	7,0	5,5	7,0	21,0	12,0	40,0	410
Nitrogen 60°C / 140°F	1,5	2,5	1,0	2,0	4,0	4,5	18,0	280
Nitrogen 80°C / 175°F	3,5	5,5	2,5	5,5	7,0	8,0	33,0	360
CO <sub>2</sub> 60°C / 140°F	13	26	30	56	58	58	160	950
CO <sub>2</sub> 80°C / 175°F	29	73	48	63	97	71	210	1500



### 6. Compound Selection- SurfaPlus

#### SurfaPlus Modification

SurfaPlus surface treatment is the solution for the high frictional resistance of elastomers.

Rubber (also classified as an elastomer) plays a leading role in the fascinating world of sealing. And with good reason - this material has a large number of excellent characteristics. Rubber is flexible and resilient, strong, easy to manufacture and to use, resistant to a wide range of media and temperatures and attractively priced.

One disadvantage is that the frictional resistance of rubber, particularly in dynamic applications, can lead to wear and the generation of (excessively) high frictional heat at the seal. Also the sticking of O-rings in the packaging causes a lot of problems in automatic assembly. The introduction of ERIKS new 'SurfaPlus' surface treatment programme for rubber products relegates these problems to the past.

This brochure introduces the most common surface treatment products for rubber products. Each is capable of making a significant contribution to the improved performance of your seals. We will also inform you about the early stages of a new development and explain that specific targets can be attained via the use of various treatments. Thus it is of great importance that the surface treatment chosen for your specific application is tested in advance. Contact your nearest ERIKS branch for advice without obligation about an ERIKS 'SurfaPlus' surface treatment for rubber products. Our specialists will be happy to explain all the various options. Material specifications are available for all the surface treatments.

The extensive ERIKS 'SurfaPlus' surface treatment programme for rubber products offers you countless ways of improving your seals for specific applications. We will explain the most frequently used treatments here.

#### 1. Lowering frictional resistance in dynamic applications

We use a spray applied PTFE based coating to lower the frictional resistance of rubber. The use of this coating involves a complex pre-treatment process ranging from cleaning to sintering. This must be carried out with great care. The coating thickness for use in dynamic applications is 0.020 mm. The level of adhesion of the PTFE layer to the mother material is particularly high.

#### 2. Problem free automatic assembly with O-rings

To avoid O-rings in bulk packaging sticking to each other (possibly causing problems to arise when the rings are used for automatic assembly in mass production) we coat these seals with a thin layer of PTFE. Because large numbers are involved in this type of application price plays an important role.

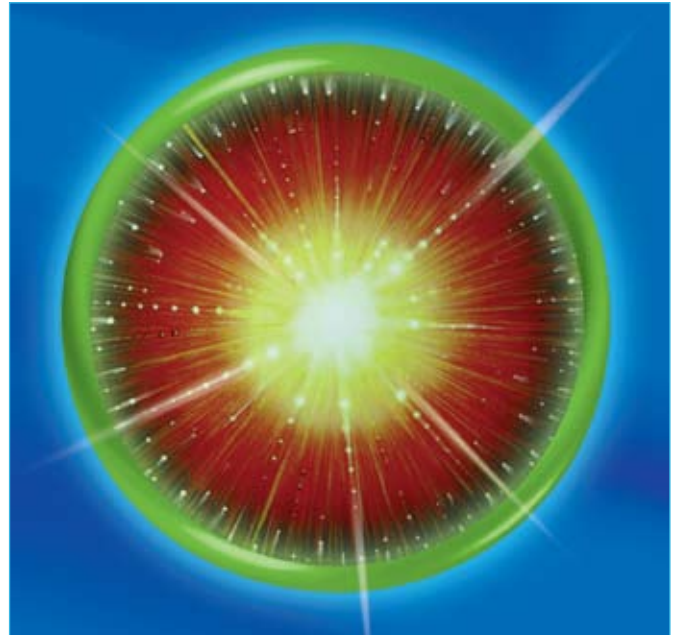

Thus ERIKS has selected dip-spin application and a thickness of approximately 0.005 mm. The coating dries to a splotchy, milky appearance. This coating (SP 10105) is FDA approved in conformance with HHS 21 CFR 175.300 and 177.1520. A polysiloxane coating can also be chosen for this application. However this coating must be spray applied and sintered, so the price is somewhat higher than the thin the PTFE coating mentioned above. On the other hand the polysiloxane provides the smoothest surface. We are continuously developing new coating systems such as our PTFE based SP 10107 - a fully transparent coating for coloured rubber components.

#### 3. Increasing chemical resistance

In many applications PTFE seals are used to resist chemicals in the medium to be sealed. A big disadvantage of PTFE is that it is not resilient and is not always suitable as a sealing material. In many instances the solution is a rubber seal coated with a 0,02 up to 0,03 mm thick PTFE layer. By doing this you combine the outstanding properties of an elastomer (such as the good compression set, tensile strength etc) with those of the chemical resistant PTFE. Products coated with this PTFE based ERIKS 'SurfaPlus' coating have an elongation of at least 100%!

In addition to this frequently used PTFE treatment, a fluoroelastomer coating may also be applied to rubber products to increase chemical resistance. This method is mainly used on very large rubber products made of NBR or EPDM, because it is cheaper than making the entire product from fluoroelastomer. The coating thickness is approximately 0.050 mm.

### 6. Compound Selection - SurfaPlus

#### 4. Surface cleaning ('labsfrei')

In many applications no contamination is allowable, including that from rubber seals. For applications such as the semiconductor industry, food and pharmaceuticals and the automotive industry, seals are thoroughly cleaned using a plasma treatment. Here the surface of the seal is subjected to an ultra-fine cleaning process using a reactive gas under vacuum. Incidentally this process can also be used for treating synthetic materials and metals.

#### 5. Easy cleaning

CIP or SIP are used for cleaning in many processes. Rubber seals coated with 0.020 mm thick PTFE from the ERIKS 'SurfaPlus' rubber surface treatment range are recommended for these methods.

#### Advantages:

- The product that is to be sealed adheres less strongly to the PTFE surface, making cleaning the machine quicker and easier.
- The seal is not damaged by low-pressure cleaning and/or hot water with a cleaning agent.

#### 6. Preventing ageing

NBR products that are coated with PTFE are resistant to the penetration of ozone and UV radiation and thus are very suitable for use in the open air and in electrical equipment.

#### 7. The right colour, easily recognisable and visually attractive

A number of the coatings described can be manufactured in the RAL colour of your choice. This applies particularly to a number of our PTFE coatings and for our fluoroelastomer treatment. These are mainly used in decorative applications.

#### The many advantages of SurfaPlus surface treatment for rubber products

- aids assembly: eases assembly of all rubber products; ideal for automatic assembly of O-rings.
- dry lubrication: improves running characteristics in cases of poor lubrication - even dry running is possible.
- better cleaning: no clinging of product making cleaning easier. Good resistance to SIP and CIP.
- chemical resistance: PTFE based coatings increase the chemical resistance of rubber sheet.
- stops ageing: slower rate of ozone influenced ageing.
- colour: coating with the colour you require is possible if volumes are sufficient.
- FDA approval: PTFE based coatings with FDA approval for food and pharmaceutical products.
- clean room': including making rubber products 'Labsfrei' for automotive, semiconductor and food & pharmaceutical applications.
- flexibility: rubber products with a 'SurfaPlus' coating have 100 to 150% elongation.

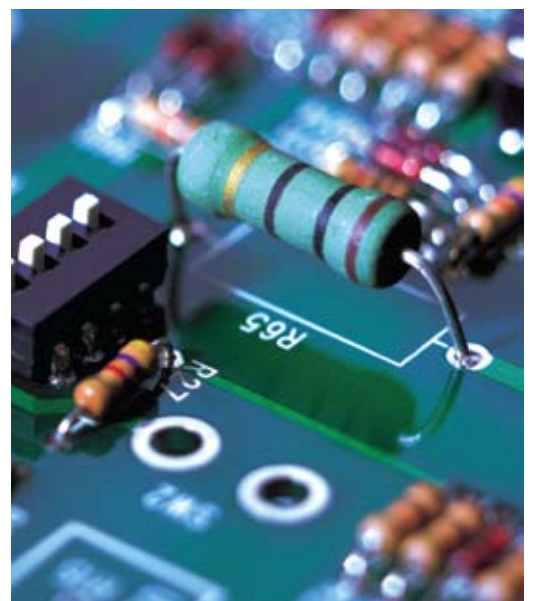
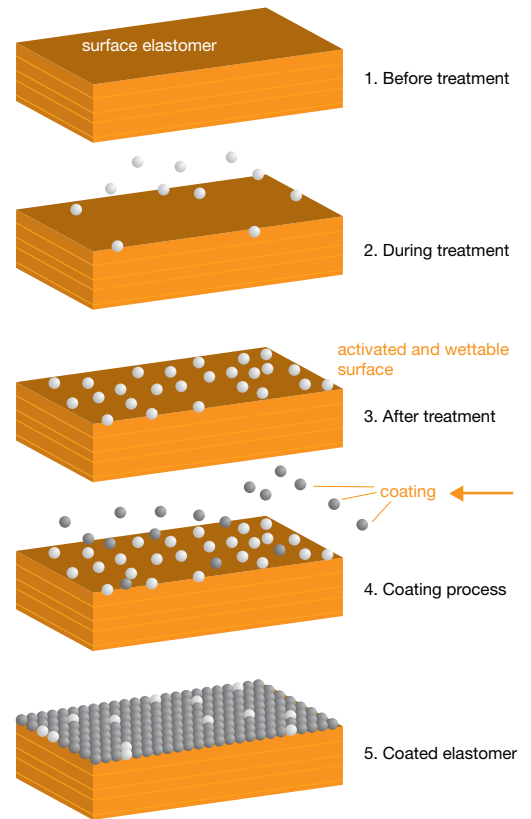

### 6. Compound Selection - SurfaPlus

**Brief summary of the available 'SurfaPlus' surface treatments for rubber products**

ERIKS designation	coating thickness	most common applications	remarks
PTFE	5 mu	to aid assembly, friction reduction for light applications	FDA approval, dries splotchy
PTFE SP 10020	20 mu	to aid assembly, friction reduction in general applications, improving chemical resistance other colours possible	particularly strong coating; for general use; standard colour grey,
Polysiloxan SP 30605	5 mu	to aid assembly, particularly for O-rings and moulded products	provides smoothest surface
Plasma SP 24000	na	cleaning of rubber products, for clean room production, food and pharmaceutical	making 'labsfrei', increases surface hardness by a few Shore points
FKM SP 83050	50 mu	increasing chemical resistance	only viable for very large moulded shapes or profiles, available in several colours
MOS <sub>2</sub> SP 40505	5 mu	to aid assembly, mainly for O-rings	powder coating, easy to apply and economical. Chalks.

Disclaimer:

Not all of the above mentioned surface treatments will show all their benefits on every elastomer.

As with any material, evaluation of any compound and their surface treatment under end-use conditions prior to specification is essential. Since conditions of product use and disposal are outside of our control, we make no warranties, express or implied, and assume no liability in connection with any use of this information. Do not hesitate to contact your local ERIKS application engineer – we will be delighted to be of assistance to you.

### 8. NEW: SurfaPlus® NANO-F:

ERIKS latest technique is a constant further development of already existing surface treatments under consideration of latest technological advances.

This innovative treatment made it possible to engage with the molecular structure of the surface of elastomers. ERIKS is able to change the properties of the surface permanently without alloying the physical properties.

Due to the fact that SURFAPLUS NANO-F is not a coating, the dimensional tolerances of the treated part do not change according to the thickness of a certain coating.

This innovative technique is as well suitable for automatic mounting as for reducing the coefficient of friction.

Even undercuts or complex geometries are no problem – that's why SURFAPLUS NANO-F is also suitable for moulded parts.

This treatment can also be executed on plastics.

At the same time SURFAPLUS NANO-F activates the surface of the treated part – that leads to better results at later glueing, flocking or painting.

Although this is a new and complex technology, ERIKS is able to offer this treatment on a equal price-level in comparison to common coatings and treatments – for low as well as for high volume applications.

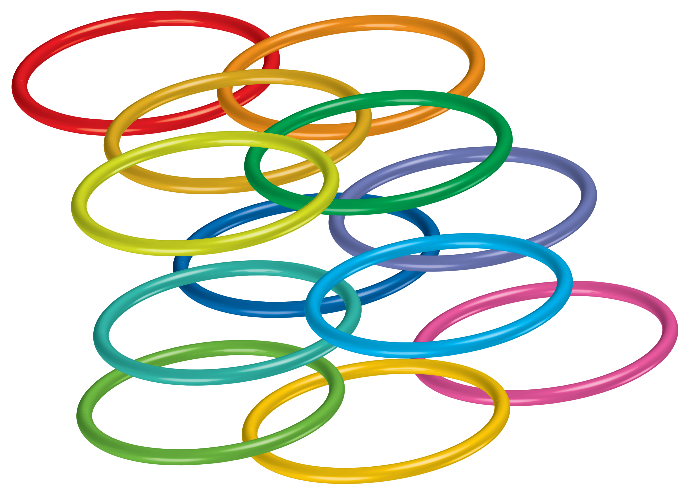

### 6. Compound Selection - Bio-Hygienic®

#### 1. What is Bio-Hygienic®?

A family of pro-active silver filled elastomers which give a continuous protection against microorganisms.

#### Problem

Our world is full of microorganisms. Some are not dangerous and help the digestion; some are in foodproducts like cheese and beer. Others are dangerous and can provoke diseases like MRSA (the hospital bacteria).

Rubberparts and seals are a source for microbial growth due to the fact rubber contains additives which are a breeding ground for microorganisms. These rubberparts are also mainly used in a humid environment, conditions which are ideal for growth.

#### Solution

Bio-Hygienic® compounds contain active silverdiocides which stop the growth of bacteria. As soon as the bacteria or the microbes makes contact with rubber, it absorbs the free silver ions which are at the surface of the rubber. Bio-Hygienic® kills the bacteria or microbes by deterioration of the cellular wall. In addition, the pH-value in the cell is changed in a way that they no longer multiply.

Bio-Hygienic® remains active after a long time even after CIP/SIP cleaning procedures.

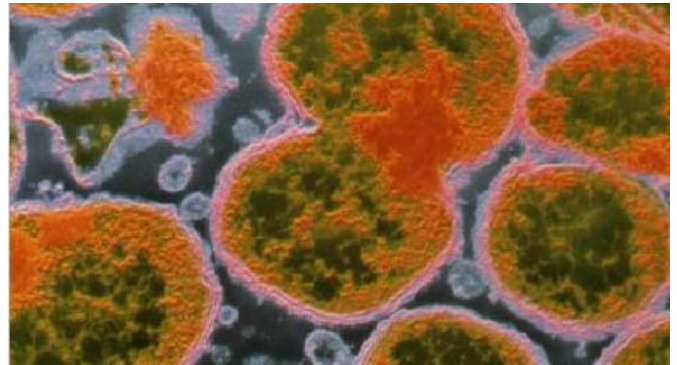

On standard rubber compounds microorganisms develop easily which leads to impurities and odours..



Bio-Hygienic®: the active silverdiocides stop the bacterial growth.

#### Bio-Hygienic® additives are certified by the following bodies:

- FDA Food and Drug Administration
- EPA Environmental protection Agency
- FIFRA Federal Insecticide, Fungicide and rodenticide Act
- EFSA European Food Safety Agency

## 6. Compound Selection - Bio-Hygienic®

### 2. ERIKS standard compounds

Bio-Hygienic® compounds are produced following strict norms certifying an homogenous repartition of the ions. The compounds are frequently tested in our laboratory.

ERIKS offers the following Bio-Hygienic® compounds:

- HNBR 70 shore, auburn, peroxide cured
- EPDM 70 shore, white peroxide cured
- VITON® 70 shore, auburn
- MVQ Silicone 70 shore, transparent FDA
- MVQ Silicone 70 shore, transparent USP

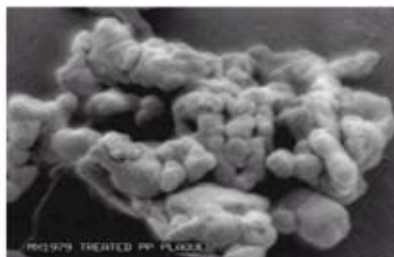
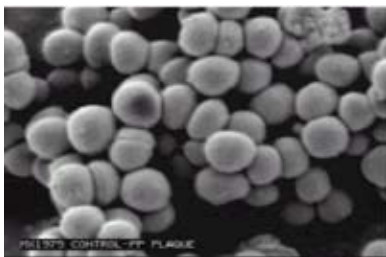

Bacterial growth...

... not anymore with Bio-Hygienic®!

### 3. Advantages of Bio-Hygienic®

- The silver ions remain active after many cleaning procedures
- Seals are often located where CIP/SIP hardly comes.  
With Bio-Hygienic® this potential threat is covered
- Low maintenance costs
- Odourless, tasteless
- Withstand up to 200°C depending on the compound
- Can be manufactured in many forms

## 6. Compound Selection - Bio-Hygienic®

### 4. Delivery program

- Sanitary seals for DIN 11851
- Inflatable seals
- TPeRX® profiles
- O-rings
- Custom made rubberparts
- Tri-Clover fittings
- Hoses in rubber and PUR



## 7. Specifications - MILSPEC's

Specifications are important. Therefore even though it may be difficult to prepare, a performance specification is recommended. Avoid specifying how to compound materials or how to process compounds. A well qualified supplier knows the materials and processes to produce the best compound for an application. However it should be understood that if one physical property of a compound is changed or adjusted by compounding, all of its other properties may be affected and it will no longer be the same compound. This is important for O-rings meeting Military Specifications. Once the specification is designated, all its requirements must be met. Even if a new compound will meet all the physical and chemical requirements of a given Military Specification, it is still impos-

sible to certify that it meets that MILSPEC because the MILSPEC is covered by a Qualified Products List (QPL) which means all test results must be verified and approved by the U.S. Government. They will not allow a variation to a Military Specification and it will be necessary to run a complete evaluation of the new compound to all the requirements. ERIKS offers compounds approved to nearly every industry wide specification for elastomeric seals. Those specifications include military, aerospace, ASTM, SAE, automotive, petroleum industry, and commercial. The most widely used specifications are the AN, M, MS, and NAS. This reference table is arranged by drawing number. Currently many MILSPEC's are being converted to non-military AMS spec's.

Popular military/aerospace specifications

Drawing number	Specification	Fluid	Recommended Temp. range °F	Elastomer	Comments
AS 3569	AMS 7270	Aircraft fuels	-67 +302	Nitrile	Formerly AN 123951 - AN 123040
AS 3570	AMS 7274	Petroleum based aircraft lubricating oil	-67 +302	Nitrile	Formerly AN 123851 - AN 123950
AS 3578	AMS 7271	Aircraft fuels	-58 +257	Nitrile	Formerly MS 9020 and MS 9021
AS 3582	AMS 3304	Dry heat and petroleum based lube oils	-85 +400	Silicone	Not recommended for high pressure dynamic applications
M 25988/1	MIL-R-25988 Class 1, Grade 70 I	Aircraft fuels and lubricants	-70 +392	Fluorosilicone	Blue color as required by MILSPEC. Not recommended for high pressure dynamic applications.
M 25988/2	MIL-R-25988 Class 3, Grade 75 I	Aircraft fuels and lubricants	-70 +437	Fluorosilicone	Blue color as required by MILSPEC. Higher modulus and temperature resistance
M 25988/3	MIL-R-25988 Class 1, Grade 60 I	Aircraft fuels and lubricants	-70 +392	Fluorosilicone	Blue color as required by MILSPEC. Lower hardness. For low pressure applications
M 25988/4	MIL-R-25988 Class 1, Grade 80 I	Aircraft fuels and lubricants	-70 +392	Fluorosilicone	Blue color as required by MILSPEC. Higher hardness.
M 83248/1	MIL-R-83248 Class 1 I	Aircraft fuels and lubricants	-20 +400	Fluorosilicone	Excellent resistance to compression set.
M 83248/2	MIL-R-83248 Class 2 I	Aircraft fuels and lubricants	-20 +400	Fluorosilicone	Higher hardness.
M 83461/1A	MIL-P-83461 I	MIL-H-5606	-65 +275	Nitrile	Better dynamic performance and longer service life at 257 °F.
MS 28775	MIL-P-25732 I	MIL-H-5606	-65 +275	Nitrile	MIL-H-5606 is a petroleum-based hydraulic fluid used in military aircraft. Inactive for new designs. See M 83461/1A.
MS 28900	AMS 3209	Ozone	-40 +212	Neoprene	For weather resistant seals. (Nonstandard sizes).
MS 29512 MS 29513	MIL-P-5315 I	Aircraft fuels	-65 +158	Nitrile	This drawing covers tube fitting sizes only. This drawing covers all sizes except the tube fitting sizes.
MS 29561	MIL-R-7362, Type I	Synthetic diester jet engine lubricants (MIL-L-7808)	-65 +257	Nitrile	This drawing covers all sizes except the . tube fitting sizes
MS 9385 MS 9386	AMS 7267	Dry heat and petroleum-based lube oils	-85 +500	Silicone	This drawing covers tube fitting sizes only. This drawing covers all sizes except the tube fitting sizes.
NAS 617	MIL-R-7362, Type I	Synthetic diester jet engine lubricants (MIL-L-7808)	-65 +257	Nitrile	This drawing covers all sizes except the tube fitting sizes

### 7. Specifications

There are some major points which must always be considered when preparing any specification. Different size parts give different results and all parts with varying cross section or shape will not meet specific properties set up on another particular part or on test specimens cut from a standard test sheet. Therefore always use standard test specimen or the same cross section of the O-ring. It is also recommended that standard test methods be used whenever possible. ERIKS data are specified according ISO, ASTM, and DIN Test standards.

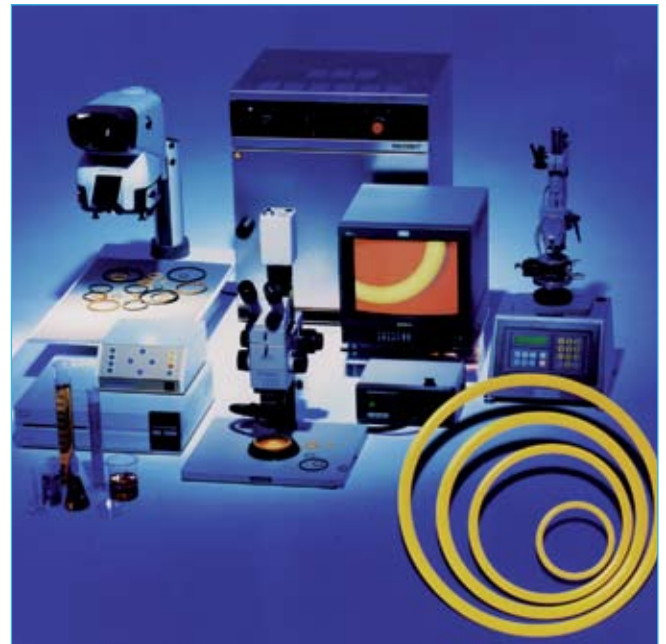



### 7. Specifications - ASTM D2000

#### ASTM D2000 Specification

One of the most versatile specifications in the Rubber Industry is ASTM D2000. In this specification the various classes, grades, and suffixes are used to define specific properties of elastomers.

#### ASTM D2000 protocol

Because there are at least as many elastomer compound choices as there are metallic products, how can one make an informed elastomer seal selection?

The relative performance capabilities of elastomers can be generally defined by a test protocol identified as American Society for Testing and Materials (ASTM) D-2000. This protocol positions an elastomer as a function of its thermal stability and oil resistance, both measured under well-defined test conditions.

Significant differences exist in the performance capabilities of the different elastomers. Those with more limited performance are recognized as mid-performance elastomers, including butyl rubber, chloroprene rubber (CR), ethylene propylene rubber (EDPM), and acrylonitrile-butadiene rubber (NBR).

Those with the broadest capabilities are high-performance elastomers. They include fluoroelastomers and perfluoroelastomers.

Yet, ASTM D2000 does not address resistance to harsh media and aggressive environments encountered in the chemical industry. These include acids, bases, solvents, heat-transfer fluids, oxidizers, water, steam, etc. Unlike ASTM #3 oil used in the ASTM D2000 protocol, chemical plant media may attack the elastomer's back-bone, crosslinks, and/or fillers leading to loss of resiliency (memory) and seal failure.

Although ASTM D2000 is a good predictive starting point, one must accurately identify the media to correctly select an elastomer for many applications.

The following example shows a typical ASTM D2000 callout. Below is a breakdown explaining what the different positions mean.

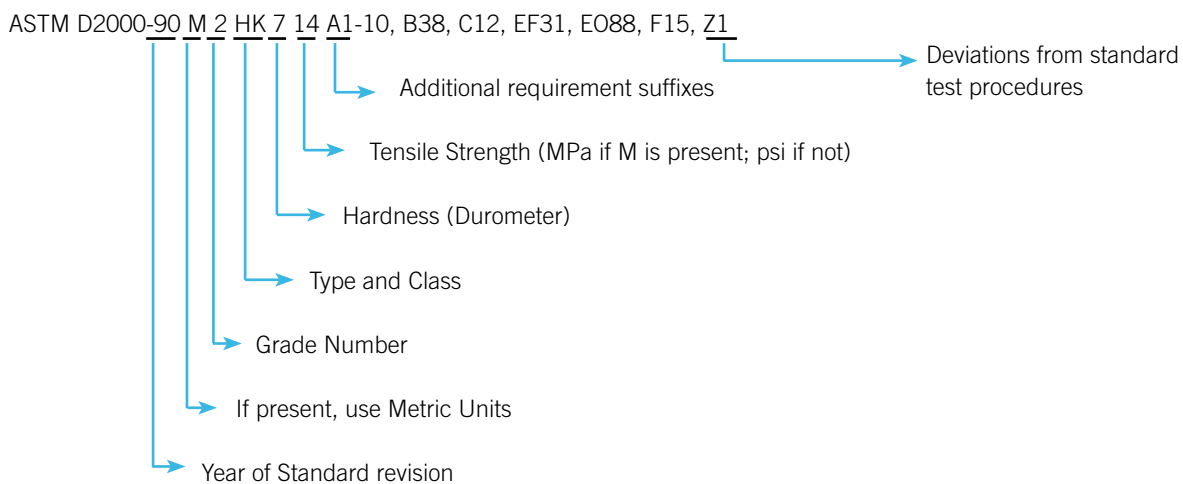

### 7. Specifications - ASTM D2000

Confusion often seems to start at the number 90. This just defines the revision year of ASTM D2000 to which the particular line callout makes reference. The appearance of an 'm' (or lack of) determines the units to be used for properties such as tensile strength, temperature or tear strength. If an M begins the line callout, SI units (metric) will be used - MPa (tensile), °C, kN/m (tear). If it is not there, English units are employed so that tensile will be in psi, temperatures in °F, and tear strength in psi.

After the M, a Grade Number is selected that defines the test requirements to which a material of a given Type and Class can be tested. A grade of 1 indicates only basic properties are required while numbers 2-9 imply additional testing requirements such as low temperature brittleness or special heat aging tests. (Note: not all grade numbers are applicable to all material types and classes).

The various material Types and Classes available are best summarized in the following table:

Material Designation (type and class)	Type of Polymer Most Often Used
AA	Natural, Reclaim, SBR, Butyl, EPDM, Polyisoprene
AK	Polysulfides
BA	EPDM, High Temp SBR and Butyl Compounds
BC	Chloroprene
BE	Chloroprene
BF	NBR
BG	NBR, Urethanes
CA	EPDM
CE	Chlorosulfonated Polyethylene (Hypalon®)
CH	NBR, Epichlorohydrin
DA	EPDM
DF	Polyacrylic (Butyl acrylate type)
DH	Polyacrylic
FC	Silicones (High Temp)
FE	Silicones
FK	Fluorosilicones
GE	Silicones
HK	Fluorocarbons

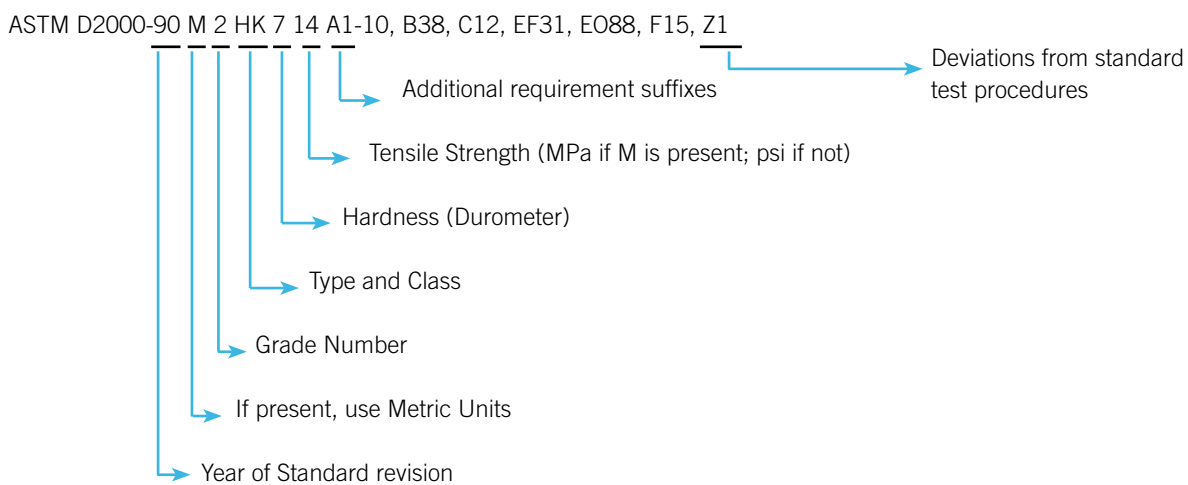

### 7. Specifications - ASTM D2000

Next in line are three numbers used to state hardness range and minimum tensile strength requirements. The first number 7 indicates the nominal hardness 70 (in Shore A units) of the described material plus or minus 5 points. In this case the material required would be 70±5 Shore A hardness. Similarly, if a 6 was used, the material specified would be 60°±5° Shore A hardness. The next two digits are used to define the minimum tensile strength to be possessed by the material. Since the call-out is metric, the 14 requires that the material supplied have a minimum tensile strength of 14 MPa. If the M was not present, the units would be in psi so the 14 would be replaced by 20 (14 MPa =2031psi; use the first two digits of the tensile strength in psi).

In most applications, however, basic properties are not enough to ensure an acceptable material.

Specialized testing is often required and this is where suffixes come into use. Suffixes are letter-number combinations that, together with a grade number, describe specific tests and performance criteria which an elastomer must pass. Below is a listing of the relationship between suffix letters and the type of test each calls out:

A	Heat Resistance
B	Compression Set
C	Ozone or Weather Resistance
D	Compression-Deflection Resistance
EA	Fluid Resistance (Aqueous)
EF	Fluid Resistance (Fuels)
EO	Fluid Resistance (Oils and Lubricants)
F	Low Temperature Resistance
G	Tear Resistance
H	Flex Resistance
J	Abrasion Resistance
K	Adhesion
M	Flammability Resistance
N	Impact Resistance
P	Staining Resistance
R	Resilience
Z	Any Special Requirement (Specified in Detail)

The numbers connected with each suffix letter describe the test method to be used (including time) and the test temperature.

Due to space limitations we will not go into these subtitles. Z-requirements are typically used to skew hardness range (eg; 75 ±5), tighten limits on a given test, specify color (default is black), or add additional tests designed by another party. Looking back at the original example for this particular application the callout is: A 70+5 hardness, black fluorocarbon with a minimum tensile strength of 14MPa. The material will also have to pass the limits outlined in the grade 2 column (of the 1990 revision of D2000) for Heat Resistance, Compression Set, Ozone Resistance, Fuel Immersion, Lubricating Oil Immersion, Low Temperature Resistance, and a specified Z-requirement.

#### Example:

#### **2 BG 720 B14 EO14 EO34 EF11 EF21 F17 EA14 , NBR shore A 70 ± 5**

2	Quality number
B	Type (based on heat resistance)
G	Class (based on swell resistance in test oil IRM 903)
7	Hardness shore A 70 ± 5
20	Tensile strength 2000 psi (13,8 MPa)
B	Compression set (Test ASTM D395)
1	Testing time: 22 hours
4	Testing temperature: 212 F° (100°C)
EO	Swelling in test oil ASTM No1 (ASTM D471)
1	Testing time: 70 hours
4	Testing temperature: 212°F (100°C)
EO	Swelling in test oil IRM 903 (test ASTM D471)
3	Testing time: 70 hours
4	Testing time: 212°F (100°C)
EF	Swelling in test fuel No.1 (Reference Fuel A) Isooctane (test ASTM D471)
1	Testing time: 1 hour
1	Testing temperature: 70°F (21°C)
EF	Swelling in test fuel Nr. 2 (Refer. Fuel B) Isooctane/Toluol 70:30 (test ASTM D471)
2	Testing time: 70 hours
1	Testing temperature: 70°F (21°C)
F	Low temperature testing (test ASTM D746), Method B
1	Testing time: 3 minutes
7	Testing temperature: -40°F (-40°C)
EA	Swelling in water, (test ASTM D471)
1	Testing time: 70 hours
4	Testing temperature: 212°F (100°C)

(For reference test results ASTM Rubber Handbook Section 9 Volume 09.01

### 8. Qualifications

Functional requirements should always be given first. A functional test is worth more than a physical and chemical property test. Thus the first step is to set the original physical property limits which will assure that the mechanical properties desired in the O-ring are present. Be aware of the fact that there is a difference between the original physical properties and the aged physical properties.

#### Original Physical Properties:

##### Hardness

Determine the IRHD hardness best suited for the application and round off to 40°, 50°, 60°, 70°, 80°, 90° or 95°-shore A or IHRD. A  $\pm 5$  point tolerance is established to allow the manufacturer a realistic working range and permit normal variations experienced in measuring hardness.

##### Tensile Strength

Determine the minimum tensile strength necessary for the application. Always take into consideration the inherent strength of the elastomers most likely to be used to meet the specification. Most silicones have a much lower tensile strength than other elastomers. Once the minimum tensile strength has been set, multiply it by 1.20. This is the limit set for tensile strength variation of  $\pm 15\%$  experienced between production batches of a compound.

##### Elongation

Investigate and determine the maximum amount of stretch a seal must undergo for assembly in the application. Multiply this figure by 1.25 to allow a safety factor and to provide for normal production variation of  $\pm 20\%$ .

##### Modulus

Choose a minimum modulus which will assure a good state of cure, good extrusion resistance, and a good recovery from peak loads. Modulus is directly and related to tensile and elongation, and refers to the stress at a predetermined elongation, usually 100%.

##### Specific Gravity

A value for specific gravity should not be set in the qualification section of the specification but the value must be reported "as determined". The realistic figure will then be used in the control section.

#### Age Physical Properties

Determine the resistance of the O-ring to the anticipated service environment. This is done by measuring the change in volume and physical properties of test samples after exposure to various conditions for a specified time at a specified temperature. Recommended times, temperatures, and test fluids for accelerated tests can be found in ASTM D471. It is usually desirable to use the actual service fluid. Because these fluids are not as controlled as test fluids, there can be some variations. This fluid variation accounts for differences in test results.

##### Hardness Change

Hardness Change is usually controlled to avoid excessive softening (causing extrusion from pressure) or hardening (causing cracking).

##### Tensile Strength Change

A reasonable tolerance limit is usually set as insurance against excessive deterioration and early seal failure. Each individual fluid dictates its own specific limits. Experience will probably dictate these limits. However, 10% tolerance is not realistic since much wider variance in tensile strength can be experienced on two test specimens cut from the same sample.

##### Elongation Change

Experience will dictate this limit as noted under tensile change.

##### Volume Change

Determine the maximum amount of swell which can be tolerated in the O-ring application (usually 15% to 20% for dynamic and 50% for static applications). Determine the maximum amount of shrinkage which can be tolerated in the O-ring application (usually 3% for both dynamic and static). Include a dry-out test after the immersion test to provide a control for dry-out shrinkage. Shrinkage of O-rings can be a cause of failure. It is necessary to stress the difference between test results on different size seals. An O-ring with a thinner cross section will not have the same volume swell as an O-ring with a thicker cross section when tested under the same conditions. This difference is at its peak during the first 70 hours of testing (most accelerated testing is specified within this period). Only after four to six weeks the volume swell of different cross section rings approaches an equilibrium value.

##### Compression Set

A realistic value for compression set is often all that is necessary to assure a good state of cure and resilience of a compound.

##### Low Temperature Resistance

Determine the lowest temperature at which the O-ring is expected to function. Most low temperature tests are designed to indicate the brittle point of a material which only tells at what temperature the compound is most likely to be completely useless as a seal in a standard O-ring design, but very little about the temperature at which it is useful. Only the TR-10 test gives information about the lowest temperature at which the compound exhibits rubber-like properties and therefore relates to low temperature sealing capabilities. O-rings in dynamic applications will seal at the TR-10 value. O-rings in static applications will function satisfactorily to about 10°C (ca. 15°F) below this value.

### 9. Test Procedures

There are standard ASTM, ISO, and DIN procedures for conducting most of the tests on rubber materials. It is important to follow these procedures carefully in conducting tests if uniform results are to be obtained. For instance, in pulling specimens to find tensile strength, elongation and modulus values, ASTM method D412 requires a uniform rate of pull of 20 inches (500 mm) per minute. In a test, tensile strength can be found to decrease 5% when the pulling speed is reduced to 2 inches per minute, and a decrease of 30% when the speed is reduced to 0.2 inches per minute.

Different international norms for elastomers exist. In the following table is a comparison of the DIN, ISO, and ASTM norms. These norms are comparative, but can be slightly different.

#### Test Specimens

ASTM test methods include description of standard specimens for each test. Often two or more specimens are permitted, but results from the different specimens will seldom agree. The way that properties vary with the size of the specimen is not consistent. For instance, as the cross section increases, nitrile O-rings produce lower values of tensile strength, elongation, and compression set. Likewise, ethylene propylene O-rings produce a similar pattern for tensile and elongation values but not for compression set. In Fluorocarbon compounds, only the elongation changes.

In fluid immersion tests, O-rings with a smaller cross section can be found to swell more than larger O-rings, while in explosive decompression tests the smaller cross sections will have better resistance to high pressure gas.

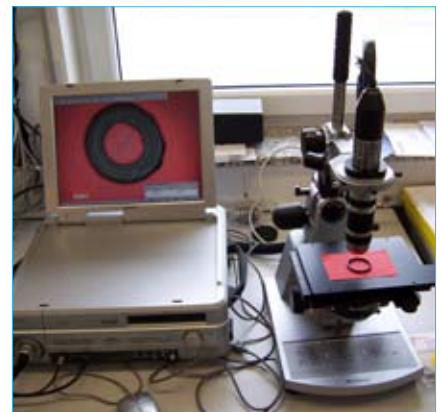
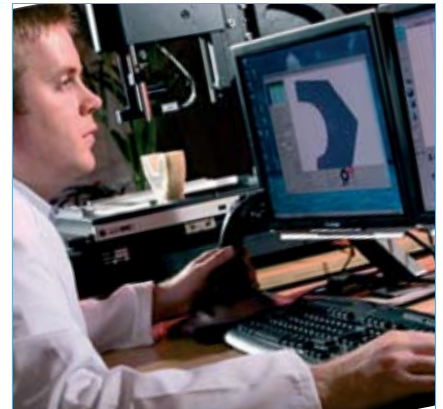
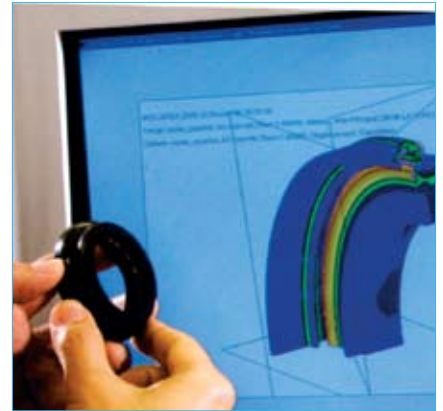

**International Standards for Elastomers**

DIN Standard	ISO Standard	ASTM Standard	Description
DIN 53519 T2	ISO 48 M	ASTM D 1415	Hardness, IRHD
DIN 53479	ISO 2781	ASTM D 1817	Specific Weight
DIN 53505	ISO 868	ASTM D 2240	Hardness, Shore A
DIN 53517	ISO 815	ASTM D 395 B	Compression Set
DIN 53504	ISO 37	ASTM D 412	Tensile Strength
DIN 53504	ISO 37	ASTM D 412	Elongation at Break
DIN 53518	ISO 2285		Tension Set
DIN 53521	ISO 1817	ASTM D 471	Immersion Test
DIN 53508	ISO 188	ASTM D 573	Aging in Air
	ISO 2921	ASTM D 1329	Low Temperature Behaviour, TR10-Test
DIN 53509	ISO 1431	ASTM D 1149	Ozone Resistance
DIN 53515	ISO 34-1	ASTM D 624	Tear Resistance

### 9. Test Procedures

#### How to properly deal with Hardness and Compression Set

**Hardness Testing** is the easiest test to carry out on O-rings, but a proper interpretation of the hardness may be difficult. The hardness commonly mentioned in the various data sheets refers to the standard measuring method by DIN or ASTM. This means that the test has been carried out on a standard slab of .08 inch (2 mm) or a button of .5 inch (12 mm) thickness. O-ring hardness measurements differ from measurements on slabs. In addition, the value per each individual O-ring cross section will vary as well: a small cross section of e.g. .08 inch (2 mm) will give higher values than a crosssection of .275 inch (7 mm) for the same compound.

To make it even more complex, a distinction must be made between the two measuring standards: Shore A and IRHD. IRHD is more and more being used for O-rings. Measuring results of both methods may differ. It is peculiar that the difference depends on the kind of rubber. HNBR will show more deviations than FKM.

What conclusion should consequently be made? With a view to the application, hardness is a parameter of relatively minor importance. The service life of an O-ring will not drastically be changed by a small difference in hardness. Please also note that data sheets always state  $\pm 5$  points on IRHD or Shore A values. It is recommended that when testing hardness, testing methods should always be the same (same equipment, same specimen). In these circumstances a comparison is useful.

**Hardness** Shore A readings taken on actual O-rings are notoriously variable because O-rings do not have flat surface and operators will vary in the accuracy with which they apply the indenter to the crown of the O-ring, the point that gives the best reliable reading. Therefore it is better to order compression set buttons from the same batch as the O-ring for the hardness test.



As to **compression set** it should be observed that one should carefully watch the information in the data sheet. In most cases the compression set stated has been measured on a slab or a button. This gives totally different values than measurements on actual O-rings. O-rings will show different values depending on the thickness of the sample. Small crosssections will give a higher value than large crosssections. The NBR and EPDM compression set values are commonly stated at 100°C (212°F); for EPDM PC at 150°C (300°F) and for VMQ and FKM at 200°C (390°F).

The lower the values, generally the better the sealing performance. See also the calculations of service life in which this subject is discussed extensively.

Compression set of the standard ERIKS O-rings is measured on an O-ring with a crosssection of .139 inch (3.53 mm). Consequently all qualities can be compared.

#### Changes in Environment

Changes in a fluid medium can occur due to the effect of heat and contaminants during service so that a rubber that is virtually unaffected by new fluid may deteriorate in the same fluid after it has been used for a certain time. For this reason it is sometimes better to run tests in used fluids.

#### Aging

Deterioration with time or aging relates to the nature of the bonds in the rubber molecules. Three principle types of chemical reactions are associated with aging.

- **Cracking.** The molecular bonds are cut, dividing the molecular chain into smaller segments. Ozone, ultraviolet light, and radiation cause degradation of this type.
- **Cross linking.** An oxidation process whereby additional intermolecular bonds are formed. This process may be a regenerative one. Heat and oxygen are principle causes of this type of attack.
- **Modification of side groups.**  
A change in the molecular complex due to chemical reaction. Moisture, for example, could promote this activity.

All mechanisms by which rubber deteriorates with time are attributable to environmental conditions. Selection and application of O-rings to provide acceptable service life is the main subject of this handbook.

### 9. Test Procedures

#### Service life of an O-ring Calculations of Service Life

For calculating the service life of O-rings ERIKS makes the assumption that the sealing life of an O-ring is zero, once the compression set has reached 100%. This indicates that the rubber has practically no elasticity and that the sealing force has become minimal so that leakage can easily develop.

The best method to determine these values is to carry out "long-term" tests at a certain temperature under a certain pressure in a certain media. This is generally done in air, being the most receptive to aging. Field tests have shown that within the same polymers name service life can vary widely e.g. 1000 to 6000 hours. Several compounds have been field tested by ERIKS for thousands of hours to determine the time at which the leakage occurs under specified conditions.

As mentioned before, the service life of O-rings depend on both the formulation quality and the product quality. The formulation quality indicates the maximum properties of the compound. This quality is generally tested on each batch. The product quality strongly depends on the production process control.

#### Life Tests

The extensive tests which preceded the determination of the O-ring service life have enabled ERIKS to give an indication of service life by means of short term tests i.e. life time tests.

A service life test is a laboratory procedure used to determine the amount and duration of the resistance of an article to a specific set of destructive forces or conditions. Today, it is possible to perform these tests under the same conditions as those prevailing in many actual situations. In this way a picture of the service life of the seal can be achieved.

Please observe that service life varies depending on the cross section and the temperature. The latest, most state-of-the-art computer programs can now predict these service life graphs by each individual cross section.

This chapter gives an example of the results of life time tests according ISO 815 for different NBR compounds: A, B, and C, 70 shore O-rings with cross section .139 inch (3,53mm). This shows that different NBR-70 compounds give different life times.

**Life tests for O-rings NBR 70° shore  
.139 inch (3,53 mm) / acc. ISO 815 / compression set 100% / hot air**



NBR compound	Compound A	Compound B	Compound C
At 140°F (60°C)	65.000 hr (6.5 yr.)	48.000 hr (4.8 yr.)	40.000 hr (4 yr.)
At 175°F (80°C)	17.000 hr (1.7 yr.)	10.000 hr (1 yr.)	9.500 hr (11 m.)
At 212°F (100°C)	3.000 hr (4 m.)	1.900 hr (2.3 m.)	1.800 hr (9 wk)
At 257°F (125°C)	740 hr (4 wk.)	500 hr (18 d.)	450 hr (16 d.)

\* Consult ERIKS for other lifetime tests.

### 9. Test Procedures

Life tests on 70 shore O-rings with a cross section of .139 inch (3,53 mm) in a sulphur cured EPDM and a peroxide cured EPDM give the following values. These values show the large difference in results between the two curing systems.

EPDM compound	Sulphur cured	Peroxide cured
At 140°F (60°C)	100.000 hr (10 yr.)	1000.000 hr (100 yr.)
At 175°F (80°C)	52.000 hr (5.2 yr.)	250.000 hr ( 25 yr.)
At 212°F (100°C)	8.500 hr (10 m.)	34.000 hr ( 3.4 yr.)

#### Factors for small c.s. .070 inch (1,78 mm)

At 175°F (80°C) : x 0.75  
 At 212°F (100°C) : x 0.65  
 At 257°F (125°C) : x 0.65

#### For large c.s. .275 inch (6,99 mm)

: x 1.80  
 : x 1.60  
 : x 1.50

Generally, in air, the service life for NBR 70 O-rings at 100°C (212°F) in the various compounds range from 2000 to 3000 hours. EPDM O-rings at 100°C (212°F) sulphur cured or peroxide cured range from 8.500 to 34.000 hours, depending on the compound. Other Eriks O-ring compound life test results are available. Please contact an ERIKS representative for more information.

These test results give the number of expected hours, during which the compression set reaches (100%) when tested in air. When testing in oils, the service life is considerably higher (not for EPDM). Warm air can be a very aggressive environment for rubber.

Since the interpretation of this data requires some explanation, please contact an ERIKS representative for more information.



### 9. Test Procedures

#### Extra service for O-rings

In addition to test procedures specified by ERIKS, there are also different possibilities for specific quality assurance systems:

- compression set testing
- hardness control following Shore A or IRHD
- surface control to Sortenmerkmal S (surface defect control)
- specific measurement to special tolerances
- special surface control
- tear strength test
- tensile strength test
- ozone testing
- lifetime testing
- chemical resistance tests
- infrared spectroscopy
- TGA-analysis
- FDA migration test
- TOC analysis
- FEA calculations
- Clean Room

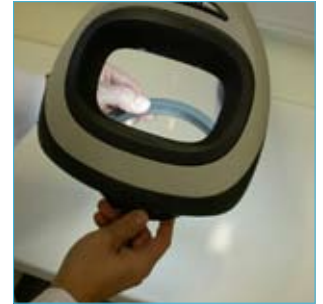

**These tests are carried out in our MTC  
(Material Technology Center)  
in Manchester, UK.**

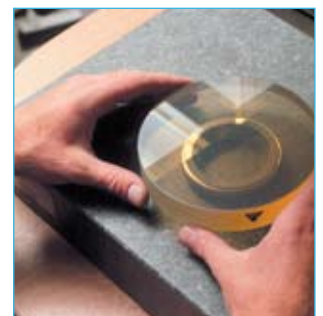
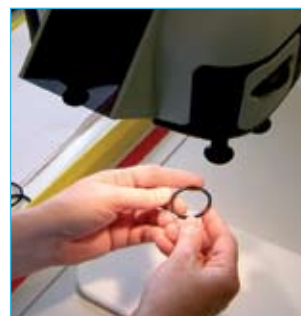
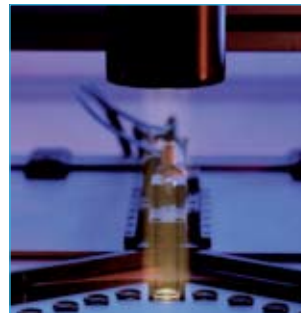

### 9. Test Procedures

#### Testing of hardness

The most used method for hardness testing of rubber parts is the Shore A. On O-rings or moulded parts the Microhardness in IRHD is more specific. The drawing shows the two methods.

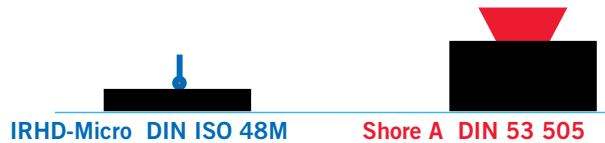

IRHD: the norm is measuring on a 2mm sheet during 30 seconds. The shore A is measured on a 6mm sheet during 3 seconds. The first method is very sensitive for surface imperfections, the second is difficult for measuring at small crosssections.

#### Compression set:

In designing an O-ring seal, it is important to determine the O-ring compound early, as the compound selected may have an influence on the gland design. The application determines the rubber compound, the primary factor being the fluid to be sealed. But the elastomer must also resist extrusion when exposed to the maximum anticipated pressure and be capable of maintaining good physical properties through the full temperature range expected.

This chapter discusses the next criteria that must be considered like compression set, hardness, tensile strength, chemical compatibility, thermal effects, pressure, and extrusion. Data and procedures enabling the designer to meet particular requirements or obtain specific performance from the seal will be found in this chapter.

#### Compression Set and Squeeze

Compression set is the percentage of deflection that the elastomer fails to recover after a fixed period of time under a specific squeeze and temperature. Compression set is a very important sealing factor, because it is a measure of the expected loss of resiliency or "memory" of a compound. Compression set is generally determined in air and measured as a percentage of original deflection. Although it is desirable to have a low compression set value, this is not so critical as it might appear because of actual service variables. For instance, an O-ring may continue to seal after taking a 100% compression set, provided the temperature and system pressure remain steady and no motion or force causes a break in the line of seal contact. Also, swelling caused by contact with the service fluid, may compensate for compression set. The condition most to be feared is the combination of high compression set and shrinkage. This will lead to seal failure unless exceptionally high squeeze is employed. Compression set is calculated as follows:

$$C = \frac{t_0 - t_1}{t_0 - t_s} \times 100 \%$$

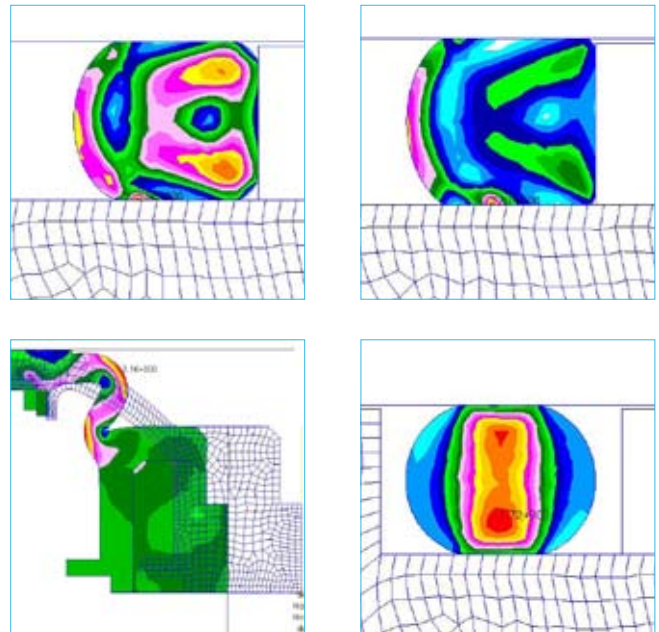

### 9. Test Procedures

#### Tensile strength and elongation:

In the tensile strength the tension limits of the rubber are determined. Tensile strength and elongation at break are the outcome of the test. The test is full DIN 53504 or ISO 37.

Elastomers are determined as follows:

- 0-5 MPa: low
- 5-10 MPa: middle
- 10-15 MPa: high
- 15-20 MPa: very high

The DIN 53504 or ISO 37 is made as follows:

- S2 rod
- speed: 200mm/min

#### Chemical resistance:

Chemical resistance tests which determine:

- volume increase
  - hardness change
  - change of network structure in the rubber
- are possible on all compounds.

Tests are carried out full DIN ISO 1817 and specific VDA test methods.

#### Aging properties/lifetime tests:

Due to tests on hardness, volume swell, tensile strength and elongation at different temperatures it is possible to define the heat resistance of seals in different compounds. Tests are carried out full ISO 188.

#### Ozon resistance:

Due to climate changes ozone at higher concentration can influence highly the lifetime of a seal or rubber part. Mainly NR and NBR at 3 to 5% elongation are very ozone sensitive. NBR with ozone protection gives much better results. Tests at different ozone concentrations, different elongations and different time (f.e. 48 hours) give comparative results. Ozone in these conditions gives scratches in the rubber. Tests are carried out full ISO 1431.

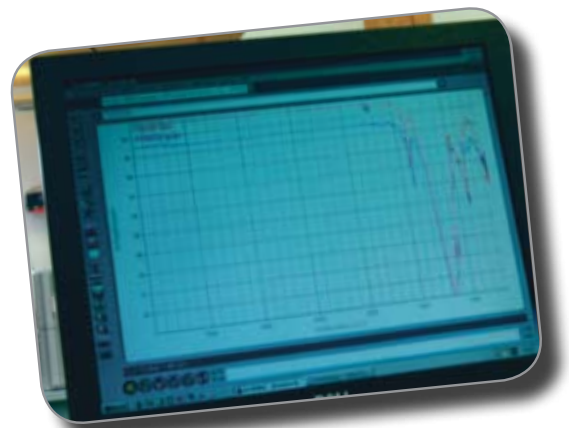

### 9. Test Procedures

#### TGA (thermographic analysis):

In this method a compound is burnt till only the ashes remain. At different temperature stages different ingredients burn and the weightchange is put in a diagram. This method gives a good idea of the composition of the compound.

#### Infrared spectroscopy (FT/R):

The resonance vibrations of the molecularconnections are registered by this method. In this way functional groups are defined and this allows to control the chemical composition of the elastomer.

#### Basler inspection machine: 100% inspection of O-rings:

Via Basler inspection machines the tolerances and the surface imperfections are controlled by a camera system

#### Cross section measurement:

Via a laser controlled system the coresection is controlled automatically

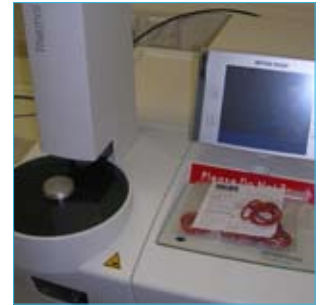

#### Surface Defects by magnification:

A 2x or 4x magnification allows us to control the surface defects of small quantities of seals.

#### Finite Element Analysis (FEA):

Our Finite Element Analysis capability allows us to provide an accurate mathematical prediction of seal performance. This technology allows us to model seal performance on the computer and ensure right first time solutions to sealing applications. The type of analysis we undertake can be as simple as that of calculating the maximum force required to insert a seal or as complex as predicted a seals performance after many years of service. We undertake customer specific projects that can combine our material testing and dynamic testing capabilities, in conjunction with FEA prediction, to provide data that provides a high level of confidence the seal will retain its integrity over the designed life of the application.

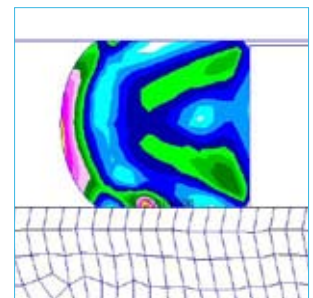
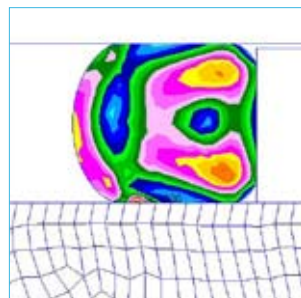

### 9. Test Procedures

#### Clean Room:

##### A clear vision on clean products

Due to a growing awareness in the field of purity, industry focuses more and more on effectively controlling manufacturing processes. Goal is to prevent technical components from being the cause of pollution in processes and systems. Pollution can originate from airborne solid particles, which can be visible or invisible. These particles are called aerosols. To avoid this type of pollution is an important factor in the pharmaceutical-, semiconductor and food industry.

#### ISO class 7

The size of a human hair is 100 µm on average. Nowadays it is possible to filter up to 0.5 µm with very good results and relatively little effort. This filtering takes place in the cleanroom. This sealed space is filled with air in which only a limited number of particles, with a size of 0.5 µm or more, float about. The current norm for the industry is ISO 14644-1. Within this norm Eriks uses ISO class 7 (also known as class 10,000) for her cleanroom. The cleaning and packing takes place in an, even tighter, class 100 environment which is accepted by 90% of the industry.

#### Cleanroom cleaning and packing

ERIKS is fully equipped to take over your cleaning and packing activities in one's own cleanroom. Out-gassing of rubber products by means of vacuum ovens is also an added ERIKS-value to the market.



### 10. Control

The purpose of control is to insure uniformity of purchased parts from lot to lot. Control may be based on the requirements of the qualification section or actual qualification test results. One should be careful not to be trapped by writing a specification based on test reports having only a single set of values. Any single set of tests made on a particular batch is very unlikely to reflect mean values that can be duplicated in everyday production. Control tests should be limited to only those properties really pertinent to the control section of the specifications.

**Dimensions** and surface quality are checked according AS 568A and AS 871 A , MIL-STD-413C, and DIN 3771 Part 1 and Part 4.

**Hardness** is often specified as a control and is frequently problematic because of inherent difficulties in measuring hardness with O-ring specimens rather than standard hardness discs. A tolerance of  $\pm 5$  points is the standard allowance for experimental error caused by reading and production variance in batches of the same compound. Hardness also has a potential for discrepancies between durometer gauges, most manufactures have a  $\pm 3$  hardness points tolerance range. Hardness is a parameter of relatively minor importance, the service life of an O-ring will not be significantly changed by a small difference in hardness.

**Elongation**, a tolerance of  $\pm 20\%$  is generally acceptable.

**Modulus**, a tolerance of  $\pm 25\%$  is standard. This is a more sensitive indicator of the condition of the compound than tensile strength and elongation. This means that it varies more from batch to batch, requiring a wider tolerance range.

**Specific Gravity**

A tolerance of  $\pm 0.02$  may be applied. ( $\pm 0.03$  for silicone)

**Volume Change**, a plus or minus tolerance on this property is frequently unrealistic because for expedience, the most critical time is usually specified for the test. This, combined with variance in commercial fluids and sample size, gives such an accumulation of negative factors, that it is not always feasible to use volume swell as a control.

#### TGA

To determine the composition of a rubber compound, thermogravimetric analysis (TGA) is a relative inexpensive method. ERIKS uses this TGA-analysis to control compounds by essentially fingerprinting the customer compound. In cooperation with the customers' quality-control department, specific TGA standards can be developed. The table below illustrates an example of TGA.

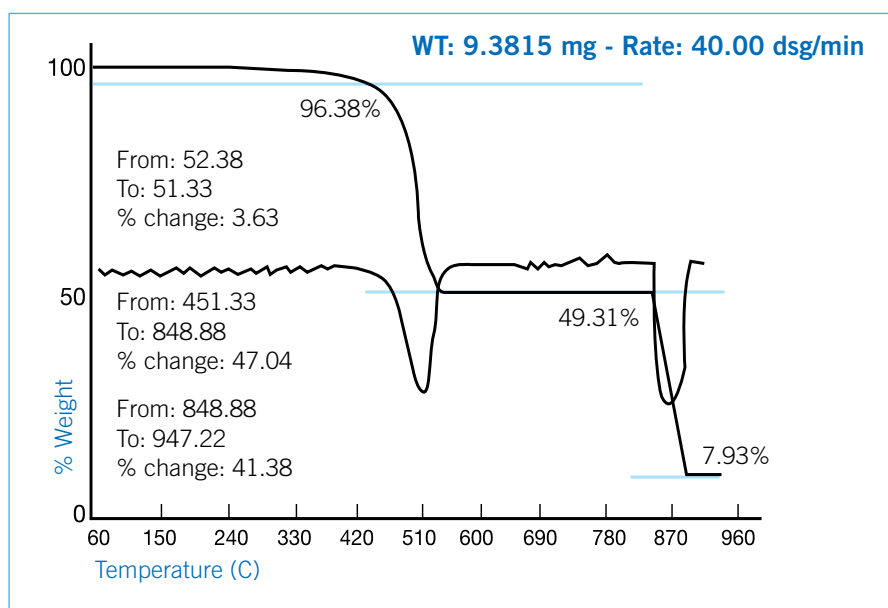

### 11. Storage and Age Control of Elastomers

#### Storage Life

According SAE-ARP5316 issue 1998-11, storage life is the maximum period of time, starting from the time of manufacture, that an elastomeric seal element, appropriately packaged, may be stored under specific conditions, after which time it is regarded as unserviceable for the purpose for which it was originally manufactured. The time of manufacture is the cure date for thermoset elastomers or the time of conversion into a finished product for the thermoplastic elastomers.

Shelf life of elastomers when stored properly is especially determined by the specific compound.

Table 3A-3 is taken from MIL-HDBK-695C and distinguishes 3 basic groups of elastomers. The values in this chart are minimal values.

In practice, longer storage periods may be used especially when 10 or 20 year categories are involved provided the parts are properly stored and periodic checks are performed.

Generally, polyethylene bags stored in cardboard containers or polyethylene lined craft paper bags insure optimal storage life.

Due to major improvements in compounding technique, storage life of relatively age-sensitive elastomers in normal warehousing conditions is considerable. MIL-HDBK-695C provides guidelines for recommended shelf life for different O-ring compounds.

**Table 3A-3 MIL-HDBK-695C**

Type of rubber	Common or Trade Name	ASTM D1418 Abbreviation	ASTM D2000 Abbreviation	MIL-STD-417 Designation
<b>20 YEARS OR HIGHER:</b>				
Silicone	Silicone	Q	FE	TA
Fluorosilicone	Silastic LS	FVMQ	FK	TA
Polysulfide	Thiokol	T	BK	SA
Fluorocarbons	Fluorel, Viton®	FKM	HK	-
Polyacrylate	Acrylic	ACM, ANM	DF, DH	TB
<b>UP TO 10 YEARS:</b>				
Chlorosulfonated Polyethylene	Hypalon	CSM	CE	-
Isobutylene/Isoprene	Butyl	IIR	AA, BA	RS
Polychloroprene	Neoprene	CR	BC, BE	SC
Polyether Urethane	Urethane	EU	BG	-
Polypropylene oxide	Propylene oxide	GPO	-	-
Ethylene/propylene	Ethylene propylene	EPDM	BA, CA	-
Ethylene/propylenediene	Ethylene propyleneterpolymercopolymer	EPM	BA, CA	-
Epichlorohydrin	Hydrin 100	CO	-	-
<b>UP TO 5 YEARS:</b>				
Butadiene/acrylonitrile	Nitrile, NBR	NBR	BF, BG, BK, CH	SB
Butadiene/styrene	SBR	SBR	AA, BA	RS
Cis-polybutadiene	Butadiene	BR	AA	RN
Cis 1, 4, polyisoprene	Natural, pale crepe	NR	AA	RN
Cis 1, 4, polyisoprene	Synthetic natural	IR	AA	RN
Polyester Urethane	Urethane	AU	-	-

### 11. Storage and Age Control of Elastomers

Experience has demonstrated that storage conditions are much more important in determining the useful life of O-rings than is time. SAE-ARP5316 addresses the general requirements for data recording procedures, packaging, and storing of aerospace elastomeric seals:

#### 1. Temperature

The storage temperature shall be below 100°F (38°C), except when higher temperatures are caused by temporary climate changes, and articles shall be stored away from direct sources of heat such as boilers, radiators, and direct sunlight.

#### 2. Humidity

The relative humidity shall be such that given the variations of temperature in storage, condensation does not occur. If the elastomers are not stored in sealed moisture proof bags, the relative humidity of the atmosphere in storage shall be less than 75% relative humidity, or if polyurethanes are being stored, shall be less than 65% relative humidity.

#### 3. Light

Elastomeric seals shall be protected from light sources, in particular direct sunlight or intense artificial light having an ultraviolet content. The individual storage bags offer the best protection as long as they are UV resistant.

Note: It is advisable that windows of storage rooms where elastomers are stored in bulk be covered with a red or orange coating.

#### 4. Radiation

Precautions shall be taken to protect stored articles from all sources of ionizing radiation likely to cause damage to stored articles.

#### 5. Ozone

As ozone is particularly damaging to some elastomeric seals, storage rooms shall not contain any equipment that is capable of generating ozone such as mercury vapor lamps, high voltage electrical equipment giving rise to electrical sparks or silent electrical discharges. Combustion gases and organic vapor shall be excluded from storage rooms as they may give rise to ozone via photochemical processes.

#### 6. Deformation

Elastomeric seals shall be stored free from superimposed tensile and compressive stresses or other causes of deformation. Where articles are packaged in a strain-free condition, they shall be stored in their original packaging. O-rings of large inside diameter shall be formed into at least three superimposed loops so as to avoid creasing or twisting.

Note: It is not possible to achieve this condition by forming just two loops, three are required.

#### 7. Contact with Liquid and Semi-Solid Materials

Elastomeric seals shall not be allowed to come in contact with liquid or semi-solid materials (for example, gasoline, greases, acids, disinfectants, and cleaning fluids) or their vapors at any time during storage unless these materials are by design an integral part of the component or the manufacturer's packaging. When elastomeric seals are received coated with their operational media, they shall be stored in this condition.

#### 8. Contact with Metals

Certain metals and their alloys (in particular, copper, manganese, and iron) are known to have deleterious effects on elastomers. Elastomeric seals shall not be stored in contact with such metals (except when bonded to them) but shall be protected by individual packaging.

#### 9. Contact with Dusting Powder

Dusting powders shall only be used for the packaging of elastomeric items in order to prevent blocking or sticking. In such instances, the minimum quantity of powder to prevent adhesion shall be used.

#### 10. Contact between Different Elastomers

Contact between different elastomers and elastomers of different seals shall be avoided.

#### 11. Elastomeric Seals bonded to Metal Parts

The metal part of bonded elastomeric seals shall not come in contact with the elastomeric element of another seal. The bonded seal shall be individually packaged. Any preservative used on the metal shall be such that it will not affect the elastomeric element or the bond to such an extent that the seal will not comply with the product specification.

#### 12. Stock Rotation

Elastomeric seal stock should be rotated on the FIFO (First In, First Out) principle.



### 11. Storage and Age Control of Elastomers

Further proposals for storage conditions and maximum life of elastomer parts can be found in the ISO 2230: Rubber products – Guidelines for storage. This guideline differs slightly from the one stated 2 pages before in the SAE-ARP5361 and MIL-HDBK-695C.

An appropriate packaging material should be free from substances having a degrading effect on the rubber. Heat-sealable opaque materials should be used unless it is not practicable or can distort the packaged product. Suitable materials are polyethylene (PE)-coated kraft paper, aluminium foil/paper/PE laminate and opaque PE film. PVC film or any other film containing plasticizer is not recommended for direct contact with rubber. PE is suitable as a single wrapping and should be at least 0,075 mm thick. Where there is a serious risk of ingress of moisture, aluminium foil/paper/PE laminate or other similar means of protection should be used to ensure protection.

**The storage of rubber parts, such as o-rings, should be indoors under specific conditions. The major differences from the SAE-ARP5361 guidelines are:**

- temperature below 25°C, away from direct sources of heat
- be patient at temperatures below 15°C due to risk of distortion due to handling of possible stiffened products – before products are placed in service, they should have been heated to 30°C
- relative humidity in storage should be less than 70%, for polyurethanes less than 65%

The ISO 2230 standard splits the maximum storage time into an initial storage period and an extended storage period which may be applied after representative samples of the stored products were inspected. Inspection should be in accordance with the relevant production specification. A visual inspection should not show permanent distortions (like creases or flats), mechanical damage (cuts, tears, abraded areas), surface cracking when viewed under a magnification of 10X or changes in surface condition such as hardening, softening or tackiness. Testing can show if the relevant performance characteristics are within the acceptable limits.

If the storage temperature is over or under 25°C the storage life will be influenced. Storage at a 10°C higher temperature will reduce the storage time by about 50% and storage at a 10°C lower temperature will increase storage time by about 100%!

**In general ERIKS recommends the following storage parameters:**

- Ambient temperature (preferably not higher than 25°C (77°F))
- Dry environment and exclusion of contamination
- Protect against direct sunlight
- Protect against radiation
- Protect against artificial light or other light sources containing UV-radiation
- Protect from ozone generating electrical devices
- Store parts without tension (never hang O-rings)

## 11. Storage and Age Control of Elastomers

### Initial and extension storage periods for unassembled components following ISO 2230

Abbreviation	Chemical name from ISO 1629	Common name
GROUP A – INITIAL STORAGE PERIOD 5 YEARS, EXTENSION STORAGE PERIOD 2 YEARS		
BR	Butadiene rubber	Polybutadiene
NR	Isoprene rubber, natural	Natural rubber
IR	Isoprene rubber, synthetic	Polyisoprene
SBR	Styrene-butadiene rubber	SBR
AU	Polyester urethane rubber	Polyurethane
EU	Polyether urethane rubber	Polyurethane
GROUP B - INITIAL STORAGE PERIOD 7 YEARS, EXTENSION STORAGE PERIOD 3 YEARS		
NBR	Acrylonitrile-butadiene rubber	Nitrile
XNBR	Carboxylic- acrylonitrile-butadiene rubber	Carboxylated rubber
HNBR	Hydrogenated NBR (with some unsaturation)	Hydrogenated nitrile
CO, ECO	Polychloromethyloxiran and copolymer	Epichlorohydrin
ACM	Copolymer of ethylacrylate (or other acrylates) and a small amount of a monomer which facilitates vulcanization	Acrylic
CR	Chloroprene rubber	Neoprene
IIR	Isobutene-isoprene-rubber	Butyl
BIIR	Bromo-isobutene-isoprene-rubber	Bromobutyl
CIIR	Chloro-isobutene-isoprene-rubber	Chlorobutyl
GROUP C - INITIAL STORAGE PERIOD 10 YEARS, EXTENSION STORAGE PERIOD 5 YEARS		
CSM	Chlorosulfonylpolyethylene	Chlorosulfonated polyethylene
EPDM	Terpolymer of ethylene, propylene and a diene with the residual unsaturated portion of the diene in the side chain	EPDM
FKM	Rubber having fluoro, perfluoroalkyl or perfluoroalkoxy substituent groups on the polymer chain	Fluorocarbon
VMQ	Silicone rubber having both methyl and vinyl substituent groups on the polymer chain	Silicone

### 12. O-ring Gland Design

Visit: [www.o-ring.info](http://www.o-ring.info)



Save time calculating and designing O-ring grooves and verify the O-ring sealing performance by checking parameters like o-ring compression, free groove volume, o-ring inner diameter stretch and even much more.

The ERIKS O-ring design calculator features the calculation of:

- o-ring dimensions for the use in a specific groove
- groove dimensions for the use of a specific o-ring
- evaluation of both, any combination of o-ring and groove

for axial seals with inner or outer pressure, piston seals and rod seals.

Worldwide unique online calculation tool taking into consideration of the thermal expansion of the groove and the O-ring. As well as the chemical volume swell or shrinkage of the O-ring.

Choose between more than 30 groove materials and 11 O-ring compounds!

Benefit from a modern user friendly design and be guided from design recommendations from info boxes.

- Easy to use
- PDF output
- Saving of your designs
- Easy search for ERIKS standard O-rings

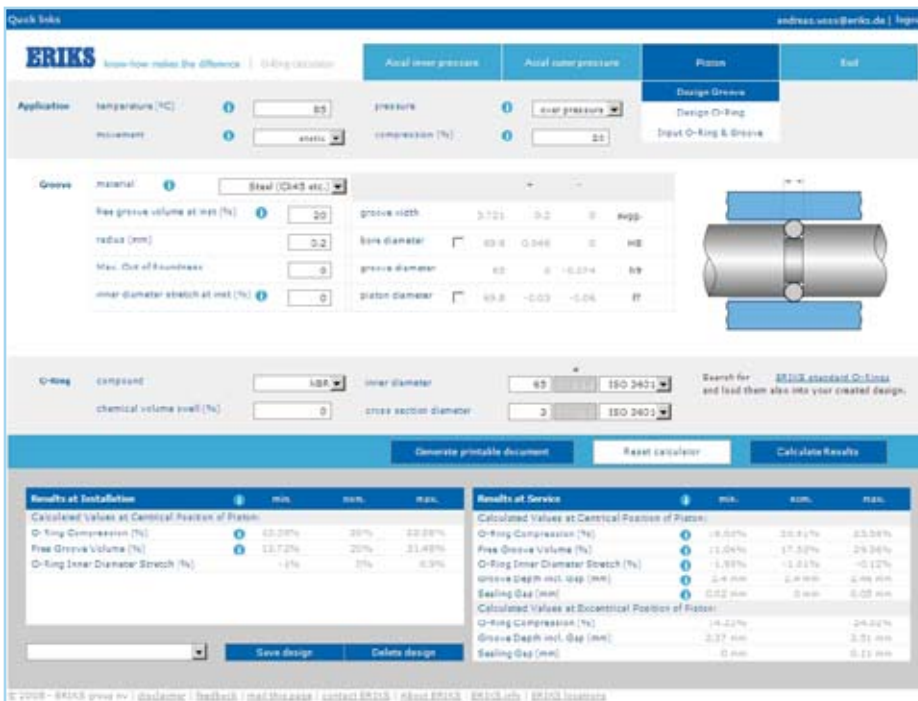

### 12. O-ring Gland Design

The following pages contain basic O-ring gland design information. Please contact the local ERIKS representative if an application does not clearly fall into these design parameters.

#### Static Applications

There are five types of static O-ring applications:

- Flange seal
- Radial seal
- Dovetail seal
- Boss seal
- Crush seal

#### Flange Seal (Axial Seal)

In flange seal glands, the two flanges are assembled with metal to metal contact. So in fact there is no remarkable gap and no risk for extrusion of the O-ring as long as the construction does not deform under system pressure. (fig. 1-26).

When system pressure is from the outside, the groove inside diameter is of primary importance and the groove width then determines the outside diameter. When system pressure is from the inside the reverse is true.

#### Radial Seal

Because the metal parts are pressed or screwed together there is always a clearance gap with risk for extrusion. (fig. 1-27).

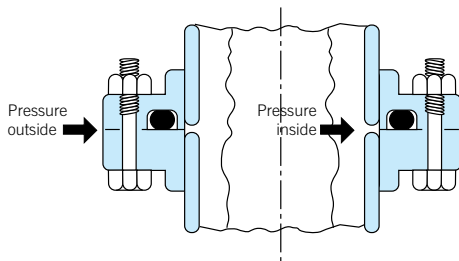

Fig. 1-26

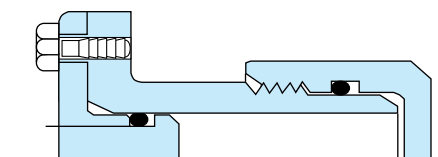

Fig. 1-27

#### Dovetail seal

Also here there is a metal to metal contact as long as the construction will not deform under system pressure. (fig. 1-30).

#### Boss seal

The groove dimensions are incorporated in the standard dimensions.

#### Surface Finish Static Grooves

Straight-sided grooves are best to prevent extrusion or nibbling. Five degree sloping sides are easier to machine and are suitable for lower pressures. Surface finishes up to 64 to 125 RMS with no burrs, nicks, or scratches are recommended.

The method used to produce the finish is important. If the finish is produced by machining the part on a lathe, or by some other method that produces scratches and ridges that follow the direction of the machinehead, a very rough surface will still seal effectively.

Other methods, however, such as end milling, will produce scratches that cut across the O-ring. Even these may have a rather high roughness value if the profile across them shows rounded scratches that the rubber can readily flow into.

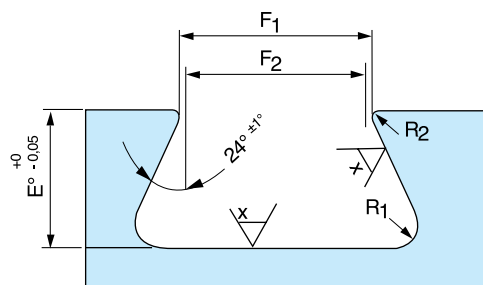

x = surface finish in  $\mu R_a$

Fig. 1-30

### 12. O-ring Gland Design

#### Dynamic Applications

There are three types of dynamic applications:

- Reciprocating Seal
- Oscillating Seal
- Rotating Seal

#### Application in reciprocating and oscillating motions

Groove dimensions for reciprocating and oscillating applications are the same.

Dynamic applications, due to the motion against the O-ring, are more complicated than static applications. Fluid compatibility must be more carefully scrutinized because a volume swell of more than 20% may lead to difficulties with high friction problems and only a minimum of shrinkage, at most 4%, can be tolerated to avoid leakage problems.

Because of the movement between the gland parts there always is a clearance gap with a potential risk for extrusion of the O-ring. O-ring seals are best in dynamic applications when used on short stroke, relatively small diameter applications. Long stroke, large diameter seals are more susceptible to spiral failure.

#### Application of O-rings in rotary motions

In a rotating application a shaft continuously rotates in the inside diameter of the O-ring, causing friction and heat. Because rubber is a poor conductor of heat, the O-ring can lose its properties. To minimize or reduce wear, the following could be done; however consult the local ERIKS representative:

- confirm amount of squeeze.
- use the smallest possible cross section.
- select an O-ring with internal lubrication or use low friction minerals.
- do not exceed a temperature of 212°F (100°C).
- do not use a shaft which is larger than the inside diameter of the O-ring.
- provide lubrication.
- do not let the O-ring rotate in the groove, only relative to the shaft.
- rough sealing surfaces of the groove will prevent rotation.
- check surface finish (may be too rough)

#### Installing the O-ring

Mating metal surfaces are generally of different metals, with one metal being softer than the other. The O-ring groove should be put in the softer of the metals. In the event that the metals wear on each other the harder metal will be less damaged, thus insuring a good sealing surface.

#### Surface Finish for Dynamic Grooves

Straight-sided grooves are best to prevent extrusion or nibbling. Five degree sloping sides are easier to machine and are suitable for pressures up to 1500 psi. (100 bar). The rubbing surfaces should be 8 to 16 RMS without longitudinal or circumferential scratches. Best surfaces are honed, burnished, or hard chrome plated. Finishes of dynamic contacting surfaces have a lot to do with the life of the O-ring seals. Appropriate surface finishes are important. Limits of maximum roughness for glands are given. Rougher finishes will cause excessive wear. Finer finishes reduce lubrication to the O-ring and may result in stick slipping and irregular wear. Surface roughness values less than 5 micro inches (0,15µmRa) are not recommended for dynamic O-ring seals. The surface must be rough enough to hold small amounts of oil. Finishes below 5 RMS wipe too clean for good moving seal life. Steel or cast iron cylinder bores are preferred. They should be thick enough not to expand or breathe with pressure, otherwise the radial clearance gap may expand and contract with pressure fluctuations-causing nibbling of the O-ring.

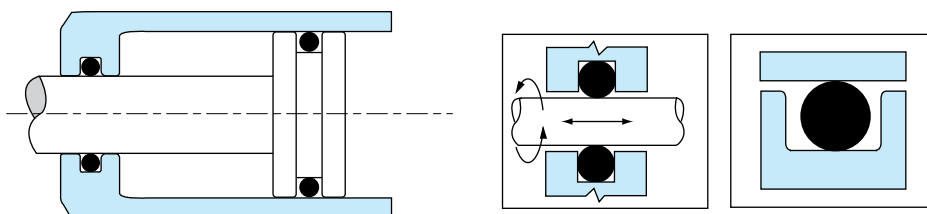

### 12. O-ring Gland Design

#### Friction

In normal applications harder materials provide less friction than softer materials. However, the higher the hardness of the O-ring, above 70 Shore A, the greater the friction. This is because the compressive force at the same squeeze, is greater than with softer materials.

Compound swell decreases the hardness and may increase friction. The lower the operating temperature the harder the seal becomes which can also increase friction. However, thermal contraction of the seal material which reduces effective squeeze may offset any increased friction caused by an increase of hardness.

Breakout friction is the force necessary to start relative motion. This is dependent upon the length of the time between cycles. It also depends on the surface finish of the metal, the rubber hardness, squeeze, and other friction-affecting factors. After standing 10 days, the breakout friction will be 2 to 5 times the friction of a seal under light load. Breakout friction can be reduced by utilizing softer O-ring or specially modified compounds.

Running friction depends on two factors: the force exerted on the ring's rubbing surface by the compression force of the squeeze and the force of the system's pressure against and tending to distort the O-ring into a "D" shape. The former depends on the hardness of the O-ring, its percentage-squeeze and the length of the rubbing surface.

The surface over which the O-ring will slide also becomes very important. It must be hard and wear resistant, it must be sufficiently smooth that it will not abrade the rubber, and yet there must be minute pockets to hold lubricant. Soft metals like aluminum, brass, bronze, monel, and some stainless steels should be avoided. Metallic moving surfaces sealed by an O-ring preferably should never touch, but if they must, then the one containing the O-ring groove should be a soft bearing material. If excessive clearance is created, extrusion will result. If adequate squeeze has not been applied, leakage will result.

If friction is excessive a variety of possible solutions exist:

- Select a different O-ring hardness.
- Select a different O-ring material with improved coefficient of friction.
- Increase the groove depth.
- Consider the use of an alternate design of seal.
- Viton® has much lower friction than NBR or EPDM or Silicone.
- Check to ensure squeeze is within the recommended range.
- Do not reduce the squeeze below recommended levels in an attempt to reduce friction. The reduction in squeeze will cause the application to leak.

#### Seal extrusion

If the radial clearance gap between the sealing surface and the groove corners (clearance gap) is too large and the pressure exceeds the deformation limit of the O-ring, extrusion of the O-ring material will occur.

When this happens, the extruded material wears or frays with cycling and the seal starts to leak.

For extrusion and direction of pressure information for static seals see fig. 1-26. In a reciprocating application the tendency for extrusion will increase if friction and system pressure act on the O-ring in the same direction. Groove design can reduce the tendency for extrusion. See figures 1-32 a & b.

If the friction of the moving metal surface across the O-ring is in the same direction as the direction of the pressure, the O-ring will be dragged into the clearance gap more readily and thus extrude at about 35% of the pressure normally necessary to cause extrusion. By placing the groove in the opposite metal part, the friction will work against pressure.

One of the best ways to reduce extrusion is to use the back-up ring (see page 147).

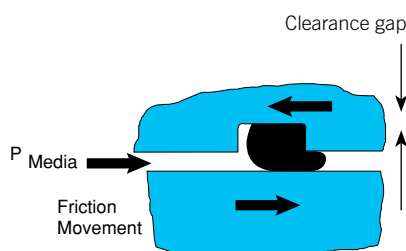

Fig. 1-32 a

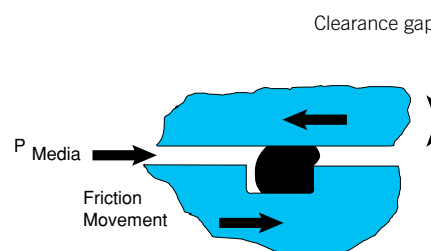

Fig. 1-32 b

### 12. O-ring Gland Design

#### Groove depth and clearance gap

The right groove depth in O-ring applications is very important because it strongly influences the squeeze of the O-ring cross section. In the tables the groove depth always includes the machined groove depth and the clearance gap. The clearance gap influences the rate of extrusion. Because it is very difficult to measure the groove depth it is better to make the calculation with the bore, plug and groove diameter as stated below.

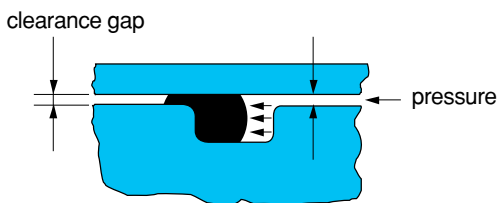
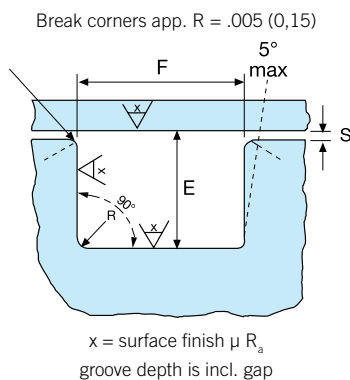

Fig. 1-19

#### Seal Design

Seals are divided into three primary categories: Static Face or Flange, Static Radial type, and Dynamic Radial type. Face or Flange type seals have no clearance gap, but consist of a groove cut into one flange with a flat mating flange bolted together to give a surface to surface contact. Static Radial Seals and Dynamic Radial Seals require the presence of a diametrical clearance gap for installation.



#### There are two types of radial designs:

1. Male or Plug - the O-ring groove is located on a plug which is inserted into the housing or cylinder (fig. 1-23)
2. Female or Tube - the O-ring groove is located in the housing or cylinder and a tube is installed through the O-ring I.D. (fig. 1-24).

Male or Plug Seal design is based on the following factors (refer to fig. 1-23).

- Bore Diameter (A)
- Plug Diameter (H)
- Groove Diameter (B)
- Groove Width (F) as shown in the dimension tables.
- Gland Depth (E) as shown in the dimension tables.

Mechanical Squeeze for the gland is determined by the bore diameter and the groove diameter in a plug or male type seal (fig. 23). The formula for determining the groove diameter(B) when the bore diameter(A) and gland depth(E) are known is:

$$B \text{ min.} = A \text{ min.} - 2 \times E \text{ max.}$$

$$B \text{ max.} = A \text{ max.} - 2 \times E \text{ min.}$$

Squeeze is measured from the bottom of the groove to the mating surface and includes the clearance gap. The following formula is used to determine the actual gland depth with tolerances:

$$\text{Max. Gland Depth} = \text{max. bore} - \text{min. groove diameter, divided by 2.}$$

$$\text{Min. Gland Depth} = \text{min. bore} - \text{max. groove diameter, divided by 2.}$$

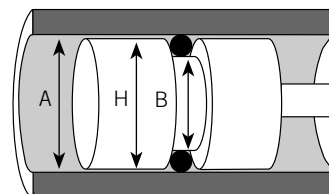

Fig. 1-23

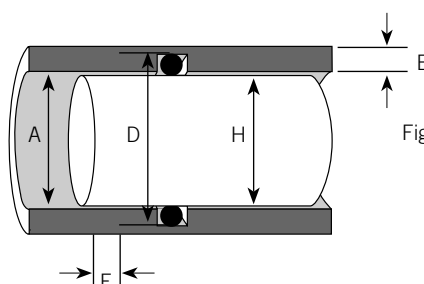

Fig. 1-24

### 12. O-ring Gland Design

Total Diametrical Clearance is the difference between the bore diameter (A) and the plug diameter (H) dimensions. Tolerances of the bore and plug diameters determine the maximum and minimum diametrical clearance gap. These values divided by two will give the radial maximum and minimum clearance gaps.

Female or Tube seals (fig 24) are based upon the following:

Bore Diameter (A)

Plug Diameter (H)

Groove Diameter (D)

Groove Width (F) as shown in the dimension tables.

Gland Depth (E) as shown in the dimension tables.

Mechanical Squeeze for this type of seal is determined by the groove diameter (D) and the plug diameter (H).

The formula for determining the groove diameter (D) when the plug diameter (H) and the groove depth (E) are known is:

$D \text{ max.} = H \text{ max.} + 2 E \text{ max.}$

$D \text{ min.} = H \text{ min.} + 2 E \text{ min.}$

Squeeze is measured from the bottom of the groove to the mating surface and includes the clearance gap. Use the following formula for determining the actual gland depth with tolerance:

Max. Gland Depth =

Max. groove diameter minus min. plug diameter, divided by 2.

Min. Gland Depth =

Min. groove diameter minus max. plug diameter, divided by 2.

Total Diametrical Clearance is the difference between the bore diameter (A) and the plug diameter (H). Tolerances of the bore diameter and the plug diameter determine the maximum and minimum total diametrical clearance gap. The size of the clearance gap is also influenced by the degree of "breathing" of the metal parts. When using the values from the tables, include in the diametrical clearance any breathing or expansion of the mating metal parts that may be anticipated due to pressure.

In some constructions the clearance gap is equal on the whole circumference of the O-ring. This is total clearance with maximum concentricity. If concentricity between piston and cylinder is rigidly maintained, radial clearance is diametrical clearance. In practice in most constructions, due to side loading and misalignment, on one spot of the O-ring circumference the clearance gap is minimum or even zero and on the opposite spot it will be maximum. This is total clearance with maximum eccentricity. (fig.20)

**Please contact the local ERIKS representative for additional information on wear bands and bearing for improving concentricity.**

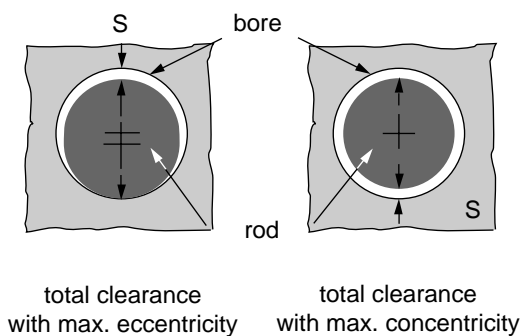

Fig. 1-20



### 12. O-ring Gland Design

The most effective and reliable sealing is generally provided with the diametrical clearance as shown in Table 3.B-1a. The maximum allowable gaps are indicated for 70° hardness O-rings with different cross sections without back-ups for reciprocating and static seals. These values correspond to a pressure of ca. 1200 PSI (80 bar) (8 MPa) at 70°F (21°C). When greater clearances occur, fig. 1-21 indicates conditions where O-ring seals may be used - depending on the fluid pressure and O-ring hardness. [See Table 3.B-1a]

Note: for silicone and fluorosilicone O-rings reduce all the clearances shown by 50%.

The diagram (fig. 1-21) gives a guide to the relation between hardness, pressure, clearance, and extrusion. This figure is based on NBR O-rings with a cross section of .139 inch (3,53 mm) without back up rings. When there is risk for extrusion use contoured hard rubber or plastic back-up rings. The results are based on tests at temperatures up to 70°C.

#### Selection of O-ring OD and ID

When selecting an O-ring ID (or an O-ring OD), consider first the stretch that will be included on the O-ring on final assembly. O-rings and grooves should be dimensioned to give acceptable stretch both on assembly and on pressurization. Table 3.C gives the O-ring/groove common dimensions for good sealing practice for several groove types.

For flange-type grooves with internal pressure, design the system so that on assembly, the O-ring OD seats onto the OD of the groove. Make sure that the O-ring OD is not larger than the groove OD to ensure a good seal. This will ensure best possible seal fit, and minimize stretch on assembly.

If the pressure direction is reversed, make sure that the O-ring ID seats onto the ID of the groove. Effectively, this ensures that when the system is pressurized the O-ring does not stretch.

In the case of a trapezoidal, or other irregularly shaped groove, first look at the pressure direction and then decide on how to minimize stretch. For the case of a trapezoidal section groove use the groove centroid as a base for determining a suitable O-ring ID. This ensures easy assembly and normally small stretch. In any case, initial stretch on assembly should not exceed 3%.

**Table 3.B-1a Gland clearance in relation to hardness and O-ring cross section**

Cross section		Max. clearance 70 Shore A	
inch	mm	inch	mm
.070	1,0-2,0	.002 - .004	0,05 - 0,1
.103	2,0-3,0	.002 - .005	0,05 - 0,13
.139	3,0-4,0	.002 - .006	0,05 - 0,15
.210	4,0-6,0	.003 - .007	0,07 - 0,18
>.275	>6,0	.004 - .010	0,1 - 0,25

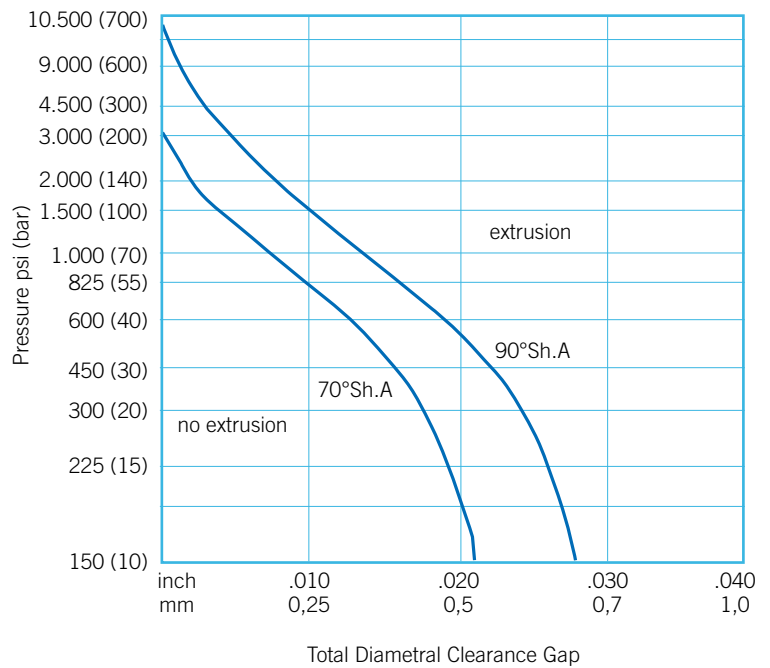

Fig. 1-21

**Table 3.C - O-ring/groove common dimensions for good seal fit**

Seal type	Pressure Direction	Common seal/groove dimensions
Flange	Internal	OD
Flange	External	ID
Crush		ID
Trapezoidal flange groove		Centroid
Piston rod/housing		ID

### 12. O-ring Gland Design

#### 12 A. Gland Design Static Axial Application

Gland Design for Static Application for O-rings with Axial Squeeze

##### Surface Finish X

groove top and bottom :

for liquids

X = 32 micro inches (0.8 μm Ra)

for vacuum and gases

X = 16 micro inches (0.4 μm Ra)

groove sides:

X = 63 micro inches (1.6 μm Ra)

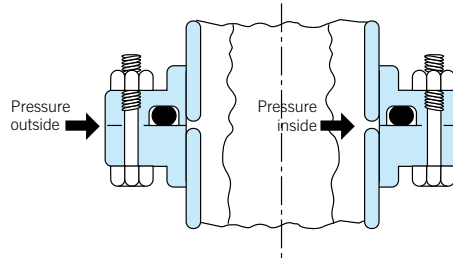

Fig. 1-26

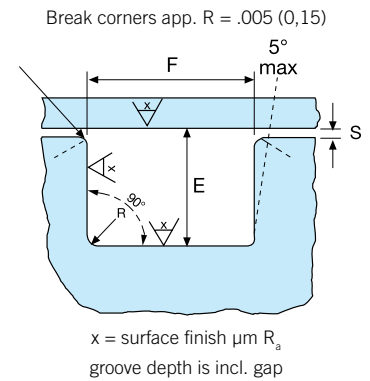

Fig. 1-27 a

Table AS C1 - Gland Dimensions (inches) Industrial Face or Flange Type

O-ring Cross section W		Gland Depth Axial Static In. E	Static Squeeze for Face Seals		Groove Width W		Groove Radius R
Nominal	Actual		Actual In	%	Liquids	Vacuum & Gases	
1/16	.070	.050/.054	.013/.023	27	.101/.107	.084/.089	.005/.015
3/32	.103	.074/.080	.020/.032	21	.136/.142	.120/.125	.005/.015
1/8	.139	.101/.107	.028/.042	20	.177/.187	.158/.164	.010/.025
3/16	.210	.152/.162	.043/.063	18	.270/.290	.239/.244	.020/.035
1/4	.275	.201/.211	.058/.080	16	.342/.362	.309/.314	.020/.035

These dimensions are intended primarily for face type seals and normal temperature applications.

### 12. O-ring Gland Design

#### Gland Design for Static Application for O-rings with Axial Squeeze Face Seal Glands (METRIC)

O-rings which are compressed axially in a static application are also called flange seals. (see fig. 26 and 27).

#### Surface Finish X

groove top and bottom :

for liquids

X = 32 micro inches (0.8 µm Ra)

for vacuum and gases

X = 16 micro inches (0.4 µm Ra)

groove sides:

X = 63 micro inches (1.6 µm Ra)

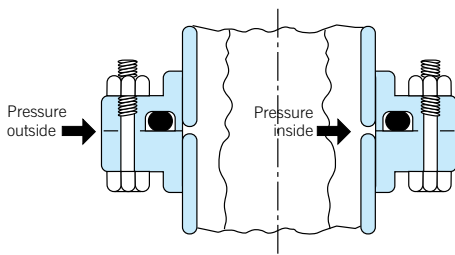

Fig. 1-26

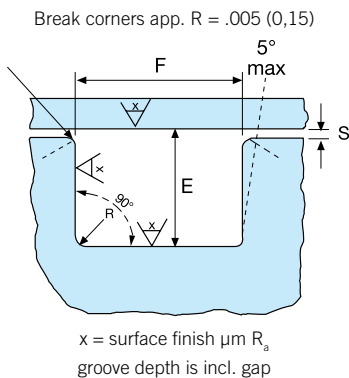

Fig. 1-27 a

Table 3.C-1 Gland Dimensions Static Application-Face Seal Glands-Metric

W O-ring cross section		E Gland Depth		F Groove Width		R Groove Radius
Diam. mm	Tol. +/- ISO 3601-1B		Tol. -0/+	Liquids Tol. -0/+0,13	Vacuum/ gases	
0,90	0,08	0,68	0,02	1,30	1,10	0,2
1,0 - 1,02	0,08	0,75	0,02	1,45	1,20	0,2
1,20	0,08	0,90	0,02	1,75	1,45	0,2
1,25 - 1,27	0,08	0,94	0,02	1,80	1,50	0,2
1,42	0,08	1,07	0,02	2,05	1,70	0,2
1,50	0,08	1,13	0,02	2,20	1,80	0,2
1,60 - 1,63	0,08	1,20	0,03	2,35	1,90	0,2
1,78 - 1,80	0,08	1,34	0,03	2,60	2,15	0,2
1,90	0,08	1,43	0,03	2,75	2,30	0,2
2,0	0,08	1,51	0,04	2,90	2,40	0,2
2,20	0,08	1,67	0,04	2,90	2,55	0,2
2,40	0,09	1,82	0,04	3,20	2,80	0,2
2,46	0,09	1,87	0,04	3,25	2,85	0,2
2,50	0,09	1,90	0,04	3,30	2,90	0,2
2,65	0,09	1,99	0,04	3,50	3,05	0,2
2,70	0,09	2,05	0,04	3,60	3,15	0,2
2,95	0,09	2,24	0,04	3,90	3,40	0,5
3,0	0,09	2,27	0,04	3,90	3,45	0,5
3,15	0,09	2,38	0,05	4,15	3,60	0,5
3,55	0,10	2,67	0,05	4,60	4,05	0,5
3,60	0,10	2,72	0,05	4,70	4,10	0,5
4,0	0,10	3,03	0,06	5,25	4,60	0,5
4,50	0,10	3,60	0,06	6,10	5,10	0,5
4,70	0,13	3,76	0,06	6,40	5,35	0,5
4,80	0,13	3,84	0,06	6,50	5,45	0,5
5,0	0,13	4,00	0,06	6,80	5,70	0,7
5,30	0,13	4,26	0,08	7,25	6,05	0,7
5,50	0,13	4,40	0,08	7,45	6,25	0,7
5,70	0,13	4,56	0,08	7,75	6,50	0,7
5,80	0,13	4,64	0,08	7,90	6,60	0,7
6,0	0,13	4,98	0,08	8,00	6,75	0,7
6,40	0,15	5,31	0,1	8,30	7,20	0,7
6,50	0,15	5,40	0,1	8,40	7,30	0,7
6,90	0,15	5,73	0,1	8,95	7,75	0,7
6,99	0,15	5,80	0,1	9,05	7,85	0,7
7,0	0,15	5,81	0,1	9,05	7,90	0,7
7,50	0,15	6,23	0,1	9,70	8,40	1,0
8,0	0,15	6,64	0,1	10,35	9,00	1,0
8,40	0,15	6,97	0,15	10,90	9,45	1,0
9,0	0,2*	7,65	0,15	11,10	10,40	1,0
10,0	0,2*	8,50	0,15	12,30	11,55	1,0
11,0	0,2*	9,35	0,15	13,55	12,70	1,0
12,0	0,2*	10,20	0,15	14,80	13,85	1,5
13,0	0,2*	11,05	0,15	16,00	15,00	1,5
14,0	0,2*	11,90	0,3	17,25	16,15	1,5
16,0	0,2*	13,60	0,3	19,70	18,45	1,5
18,0	0,2*	15,30	0,3	22,15	20,80	1,5
20,0	0,2*	17,00	0,3	24,65	23,10	1,5

\* not defined in ISO 3601/1

### 12. O-ring Gland Design

#### 12 B. Gland Design Static Radial Application

##### Gland Design for Static Application for O-rings with Radial Squeeze Industrial Radial Glands INCHES

###### Surface Finish X

groove top and bottom :

for liquids

X = 32 micro inches (0.8  $\mu\text{m}$  Ra)

for vacuum and gases

X = 16 micro inches (0.4  $\mu\text{m}$  Ra)

groove sides:

X = 63 micro inches (1.6  $\mu\text{m}$  Ra)

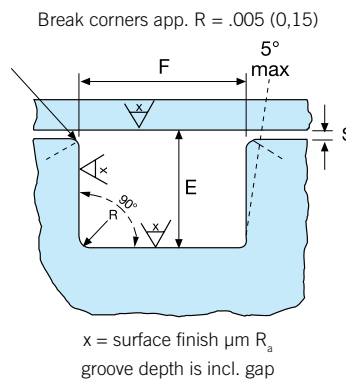

Fig. 1-27 a

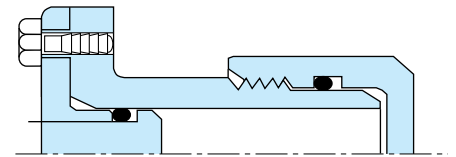

Fig. 1-28

Table AS.C2 Gland Dimensions Static Seals - Industrial Radial Applications (Inches)

O-ring Cross section W		Gland Depth. Radial Static E	Static Squeeze for Radial Seals		Clearance Diametral	Groove Width F			Groove Radius R	Max. Allowable Eccentricity <sup>1</sup>
Nominal	Actual		Actual	%		Standard	One Backup Washer <sup>2</sup>	Two Backup Washers <sup>2</sup>		
1/16	.070	.050/.052	.015/.023	22/32	*.002 min.	.093/.098	.138/.143	.205/.210	.005/.015	.005/.015
3/32	.103	.081/.083	.017/.025	17/24	*.002 min.	.140/.145	.171/.176	.238/.243	.005/.015	.005/.015
1/8	.139	.111/.113	.022/.032	16/23	*.003 min.	.187/.192	.208/.213	.275/.280	.010/.025	.010/.025
3/16	.210	.170/.173	.032/.045	15/21	*.003 min.	.281/.286	.311/.316	.410/.415	.020/.035	.020/.035
1/4	.275	.226/.229	.040/.055	15/20	*.004 min.	.375/.380	.408/.413	.538/.543	.020/.035	.020/.035

1. Total Indicator Reading between groove and adjacent bearing surface.

2. These groove dimensions are for compounds that free swell less than 15%. Suitable allowances should be made for higher swell compounds. \*

For max. allowable clearance, refer to fig. 22 to determine value based upon pressure requirement and compound hardness.

\* Maximum clearance should be reduced by 1/2 for compounds exhibiting poor strength such as silicone and fluorosilicone.

Male plug dimensions and female throat (bore) dimensions must be calculated based upon maximum and minimum clearance gaps.

### 12. O-ring Gland Design

#### 12 B. Gland Design Static Radial Application

##### Gland Design for Static Application for O-rings with Radial Squeeze Industrial Radial Glands INCHES

###### Surface Finish X

groove top and bottom :

for liquids

X = 32 micro inches (0.8 μm Ra)

for vacuum and gases

X = 16 micro inches (0.4 μm Ra)

groove sides:

X = 63 micro inches (1.6 μm Ra)

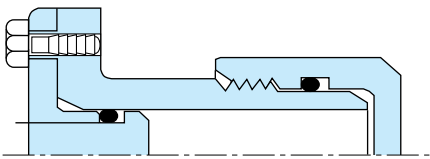

Fig. 1-28

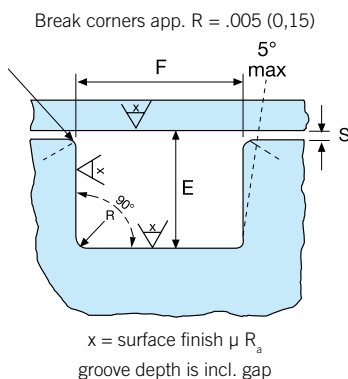

Fig. 1-27 a

Table 3.C-2 Gland dimensions Static Application-Industrial Radial Seals, METRIC

W O-ring cross section		E Gland Depth		S Diametr. Clearance	F Groove Width	R Groove Radius	Max. Eccentricity
Diam. mm	Tol. +/- ISO 3601-1B		Tol. -0/+		Tol. Tol. -0/+0,13		
0,90	0,08	0,65	0,02	0,1	1,20	0,2	0,05
1,0 - 1,02	0,08	0,72	0,02	0,1	1,35	0,2	0,05
1,20	0,08	0,87	0,02	0,1	1,60	0,2	0,05
1,25 - 1,27	0,08	0,91	0,02	0,1	1,65	0,2	0,05
1,42	0,08	1,03	0,02	0,1	1,90	0,2	0,05
1,50	0,08	1,09	0,02	0,1	2,00	0,2	0,05
1,60 - 1,63	0,08	1,16	0,03	0,1	2,10	0,2	0,05
1,78 - 1,80	0,08	1,29	0,03	0,1	2,35	0,2	0,05
1,90	0,08	1,38	0,03	0,1	2,50	0,2	0,05
2,0	0,08	1,45	0,04	0,1	2,65	0,2	0,05
2,20	0,08	1,74	0,04	0,1	3,00	0,2	0,05
2,40	0,09	1,90	0,04	0,1	3,25	0,2	0,05
2,46	0,09	1,94	0,04	0,1	3,35	0,2	0,05
2,50	0,09	1,98	0,04	0,1	3,40	0,2	0,05
2,65	0,09	2,07	0,04	0,1	3,55	0,2	0,05
2,70	0,09	2,13	0,04	0,1	3,65	0,2	0,05
2,95	0,09	2,33	0,04	0,1	4,00	0,5	0,05
3,0	0,09	2,40	0,04	0,15	4,05	0,5	0,07
3,15	0,09	2,52	0,05	0,15	4,25	0,5	0,07
3,55	0,10	2,82	0,05	0,15	4,75	0,5	0,07
3,60	0,10	2,88	0,05	0,15	4,85	0,5	0,07
4,0	0,10	3,20	0,06	0,15	5,40	0,5	0,07
4,50	0,10	3,64	0,06	0,15	6,00	0,5	0,07
4,70	0,13	3,80	0,06	0,15	6,30	0,5	0,07
4,80	0,13	3,88	0,06	0,15	6,40	0,5	0,07
5,0	0,13	4,04	0,06	0,15	6,70	0,7	0,10
5,30	0,13	4,31	0,08	0,15	7,15	0,7	0,10
5,50	0,13	4,45	0,08	0,15	7,35	0,7	0,10
5,70	0,13	4,61	0,08	0,15	7,65	0,7	0,10
5,80	0,13	4,69	0,08	0,15	7,75	0,7	0,10
6,0	0,13	4,91	0,08	0,18	8,15	0,7	0,13
6,40	0,15	5,24	0,1	0,18	8,70	0,7	0,13
6,50	0,15	5,32	0,1	0,18	8,85	0,7	0,13
6,90	0,15	5,65	0,1	0,18	9,40	0,7	0,13
6,99	0,15	5,72	0,1	0,18	9,50	0,7	0,13
7,0	0,15	5,73	0,1	0,18	9,55	0,7	0,13
7,50	0,15	6,14	0,1	0,18	10,20	1,0	0,13
8,0	0,15	6,55	0,1	0,18	10,90	1,0	0,13
8,40	0,15	6,87	0,15	0,18	11,45	1,0	0,13
9,0	0,2*	7,65	0,15	0,18	11,85	1,0	0,13
10,0	0,2*	8,50	0,15	0,18	13,20	1,0	0,13
11,0	0,2*	9,35	0,15	0,18	14,50	1,0	0,13
12,0	0,2*	10,20	0,15	0,18	15,85	1,0	0,13
13,0	0,2*	11,05	0,15	0,18	17,15	1,5	0,13
14,0	0,2*	11,90	0,3	0,18	18,45	1,5	0,13
16,0	0,2*	13,60	0,3	0,18	21,10	1,5	0,13
18,0	0,2*	15,30	0,3	0,18	23,75	1,5	0,13
20,0	0,2*	17,00	0,3	0,18	26,40	1,5	0,13

\* not defined in ISO 3601/1

### 12. O-ring Gland Design

#### 12 C. Gland Design Dovetail Grooves

##### Gland Design for a Static Application; for O-rings in Dovetail Grooves, INCHES

Dovetail grooves are used to hold the O-ring in place during installation or maintenance. This groove design is relatively uncommon as it is expensive to machine and should not be used unless absolutely required.

The dovetail groove construction is only recommended for O-rings with cross sections of .139 inch (3,53 mm) and larger.

##### Surface Finish X

groove top and bottom :

for liquids

X = 32 micro inches (0.8  $\mu\text{m}$  Ra)

for vacuum and gases

X = 16 micro inches (0.4  $\mu\text{m}$  Ra)

groove sides:

X = 63 micro inches (1.6  $\mu\text{m}$  Ra)

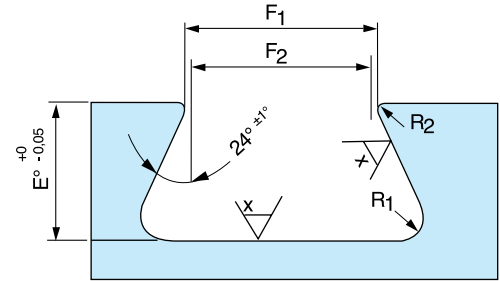

x = surface finish in  $\mu\text{m}$   $R_a$

Fig. 1-30

Table AS.C3 Gland Dimensions Dovetail Grooves, INCHES

O-ring Cross section W		Gland Depth. E	Squeeze %	Groove Width to Sharp Corner $F_2$	Groove Radius	
1/16	.070	.050/.052	27	.055/.059	.005	.015
3/32	.103	.081/.083	21	.083/.087	.010	.015
1/8	.139	.111/.113	20	.113/.117	.010	.030
3/16	.210	.171/.173	18	.171/.175	.015	.030
1/4	.275	.231/.234	16	.231/.235	.015	.060
3/8	.375	.315/.319	16	.315/.319	.020	.090

Radius "R2" is critical. Insufficient radius will cause damage to the seal during installation, while excessive radius may contribute to extrusion. R2 is size radius, R1 is machining radius.

### 12. O-ring Gland Design

#### 12 C. Gland Design Dovetail Grooves

##### Gland Design for a Static Application for O-rings in Dovetail Grooves, METRIC

Dovetail grooves are used to hold the O-ring in place during installation or maintenance. This groove design is relatively uncommon as it is expensive to machine and should not be used unless absolutely required.

The dovetail groove construction is only recommended for O-rings with bigger cross sections, .139 inch (3,53 mm) and bigger.

##### Surface Finish X

groove top and bottom :  
for liquids

X = 32 micro inches (0.8 μm Ra)

for vacuum and gases

X = 16 micro inches (0.4 μm Ra)

groove sides:

X = 63 micro inches (1.6 μm Ra)

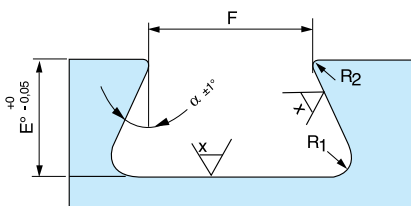

x = surface finish in μm R<sub>a</sub>

Fig. 1-30

Table 3.C-3 Gland Dimensions Dovetail Grooves, METRIC

W O-ring Cross Section mm	E Groove Depth E +/-0,05	F Groove Width F +/-0,05	α Side Wall Angle α +/-1°	R Radius	
				R <sub>1</sub>	R <sub>2</sub>
3,0	2,4	2,7	29	0,25	0,25
3,5 - 3,53*	2,8	3,15	28	0,25	0,25
4,0	3,2	3,6	32	0,8	0,25
4,5	3,65	4,05	28	0,8	0,25
5,0	4,15	4,5	24	0,8	0,25
5,33*	4,4	4,8	24	0,8	0,25
5,5	4,6	4,95	24	0,8	0,4
5,7	4,8	5,15	23	0,8	0,4
6,0	5,05	5,4	25	1,15	0,4
6,5	5,5	5,85	24	1,15	0,4
6,99* - 7,0	5,95	6,3	23	1,5	0,5
7,5	6,4	6,55	24	1,5	0,5
8,0	6,85	7,05	24	1,5	0,5
8,4	7,25	7,40	24	1,5	0,5
8,5	7,35	7,50	24	1,5	0,5
9,0	7,8	7,90	24	1,5	0,5
9,5	8,2	8,35	24	1,5	0,5
10,0	8,7	8,80	24	1,5	0,5

Groove dimensions are to be seen as an advice due to the fact they are based on our experience.

### 12. O-ring Gland Design

#### 12 D. Gland Design for Static Boss Seals

#### O-ring boss Gaskets for Straight Thread Tube Fittings

The 900-series of dash numbers identify the size of boss seals. The digits after the 9 identify the nominal tube size in 16ths of an inch. The tube size is the outside diameter (OD). For example, size 903 is intended for use with 3/16-inch OD tube.

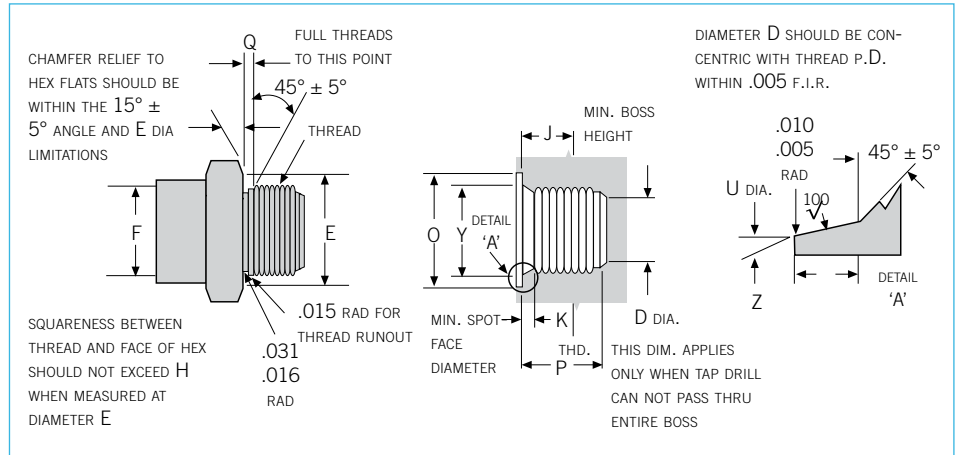

**Boss Dimensions**

AS 568 O-ring Size Nr.	Cross-section	I.D.	Tube Outside Ø	Thread	J min. THD Depth	D min.	U +.005 - .000	K +.015 - .000	Y min.	P min.	Z ±1°	O min.
-902	.064 ± .003	.239 ± .005	1/8	5/16-24 UNF-2B	.390	.062	.358	.074	.672	.468	12°	.438
-903	.064 ± .003	.301 ± .005	3/16	3/8-24 UNF-2B	.390	.125	.421	.074	.750	.468	12°	.500
-904	.072 ± .003	.351 ± .005	1/4	7/16-20 UNF-2B	.454	.172	.487	.093	.828	.547	12°	.563
-905	.072 ± .003	.414 ± .005	5/16	1/2-20 UNF-2B	.454	.234	.550	.093	.906	.547	12°	.625
-906	.078 ± .003	.468 ± .005	3/8	9/16-20 UNF-2B	.500	.297	.616	.097	.909	.609	12°	.688
-908	.087 ± .003	.644 ± .009	1/2	3/4-16 UNF-2B	.562	.391	.811	.100	1.188	.688	15°	.875
-910	.097 ± .003	.755 ± .009	5/8	7/8-14 UNF-2B	.656	.484	.942	.100	1.344	.781	15°	1.000
-912	.116 ± .004	.924 ± .009	3/4	1 1/16-12 UN-2B	.750	.609	1.148	.130	1.625	.906	15°	1.250
-913	.116 ± .004	.986 ± .010	13/16									
-914	.116 ± .004	1.047 ± .010	7/8	1 3/16-12 UN-2B	.750	.719	1.273	.130	1.765	.906	15°	1.375
-916	.116 ± .004	1.171 ± .010	1	1 5/16-12 UN-2B	.750	.844	1.398	.130	1.910	.906	15°	1.500
-920	.118 ± .004	1.475 ± .014	1 1/4	1 5/8-12 UN-2B	.750	1.078	1.713	.132	2.270	.906	15°	1.875
-924	.118 ± .004	1.720 ± .014	1 1/2	1 7/8-12 UN-2B	.750	1.312	1.962	.132	2.560	.906	15°	2.125
-932	.118 ± .004	2.337 ± .018	2	2 1/2-12 UN-2B	.750	1.781	2.587	.132	3.480	.906	15°	2.750

**Fitting End Dimensions (MS33656)**

O-ring Size Nr.	Cross-section	I.D.	Tube Outside Ø	Thread	F + .002 - .003	D max.	U ± .010	K + .015 - .000
AS-902	.064 ± .003	.239 ± .005	1/8	5/16-24 UNF-2B	.250	.005	.549	.063
AS-903	.064 ± .003	.301 ± .005	3/16	3/8-24 UNF-2B	.312	.005	.611	.063
AS-904	.072 ± .003	.351 ± .005	1/4	7/16-20 UNF-2B	.364	.005	.674	.075
AS-905	.072 ± .003	.414 ± .005	5/16	1/2-20 UNF-2B	.426	.005	.736	.075
AS-906	.078 ± .003	.468 ± .005	3/8	9/16-18 UNF-2B	.481	.005	.799	.083
AS-908	.087 ± .003	.644 ± .009	1/2	3/4-16 UNF-2B	.660	.005	.986	.094
AS-910	.097 ± .003	.755 ± .009	5/8	7/8-14 UNF-2B	.773	.005	1.111	.107
AS-912	.116 ± .004	.924 ± .009	3/4	1 1/16-12 UN-2B	.945	.008	1.361	.125
AS-914	.116 ± .004	1.047 ± .010	7/8	1 3/16-12 UN-2B	1.070	.008	1.475	.125
AS-916	.116 ± .004	1.171 ± .010	1	1 5/16-12 UN-2B	1.195	.008	1.599	.125
AS-920	.118 ± .004	1.475 ± .014	1 1/4	1 5/8-12 UN-2B	1.507	.008	1.849	.125
AS-924	.118 ± .004	1.720 ± .014	1 1/2	1 7/8-12 UN-2B	1.756	.008	2.095	.125
AS-932	.118 ± .004	2.337 ± .018	2	2 1/2-12 UN-2B	2.381	.008	2.718	.125



### 12. O-ring Gland Design

#### 12 E. Gland Design Dynamic Hydraulic

##### Gland Design for Dynamic Application Hydraulic INCHES

The following table indicates groove dimensions for reciprocating and oscillating applications when sealing hydraulic fluids and other viscous liquids.

##### Surface Finish X

groove top and bottom :  
X = 16 micro inches (0.4  $\mu\text{m}$  Ra)

groove sides:  
X = 32 micro inches (0.8  $\mu\text{m}$  Ra)

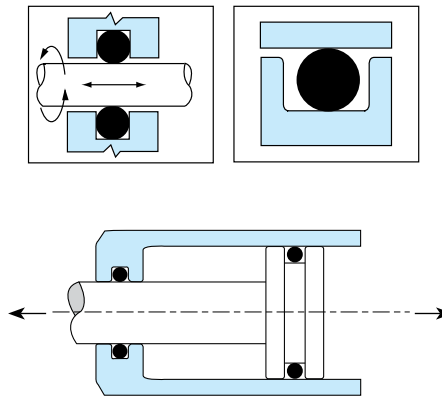

Fig. 1-33/34

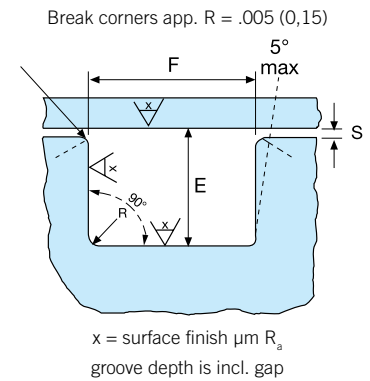

Fig. 1-27

Table AS.D1 Gland Dimensions Dynamic Seals - Industrial Reciprocating Applications, Inches

O-ring Cross section W		Gland Depth. Radial Dynamic E	Dynamic Squeeze for Radial Seals		Clearance Diametral	Groove Width ** F			Groove Radius R	Max. Allowable Eccentricity <sup>1</sup>
Nominal	Actual		Actual	%		Standard	One Backup Ring <sup>2</sup>	Two Backup Rings <sup>2</sup>		
1/16	.070	.055/.057	.010/.018	15/25	*.002 min.	.093/.098	.138/.143	.205/.210	.005/.015	.002
3/32	.103	.088/.090	.010/.018	10/17	*.002 min.	.140/.145	.171/.176	.238/.243	.005/.015	.002
1/8	.139	.121/.123	.012/.022	9/16	*.003 min.	.187/.192	.208/.213	.275/.280	.010/.025	.003
3/16	.210	.185/.188	.017/.030	8/14	*.003 min.	.281/.286	.311/.316	.410/.415	.020/.035	.004
1/4	.275	.237/.240	.029/.044	11/16	*.004 min.	.375/.380	.408/.413	.538/.543	.020/.035	.005

1. Total Indicator Reading between groove and adjacent bearing surface.

2. These groove widths are for compounds that free swell less than 15%. Suitable allowances should be made for higher swell compounds.

\*\* Groove width is based on rubber backups. For groove width with pdfc spiral wound backups see table 3.D-2.

\* For max. allowable clearance, refer to table 13.A to determine value based upon pressure requirement and compound durometer.

\* The piston dimension for male glands must be calculated by using the max. gap derived from the extrusion table 13.A and the min. gap listed above.

\* The bore diameter for female glands must be calculated by using the max. gap derived from the extrusion table 13.A and the min. gap listed above.

### 12. O-ring Gland Design

#### 12 E. Gland Design Dynamic Hydraulic

##### Gland Design for Dynamic Application Hydraulic METRIC

The following table indicates groove dimensions for reciprocating and oscillating applications when sealing hydraulic fluids and other viscous liquids.

##### Surface Finish X

groove top and bottom :  
X = 16 micro inches (0.4 μm Ra)

groove sides:  
X = 32 micro inches (0.8 μm Ra)

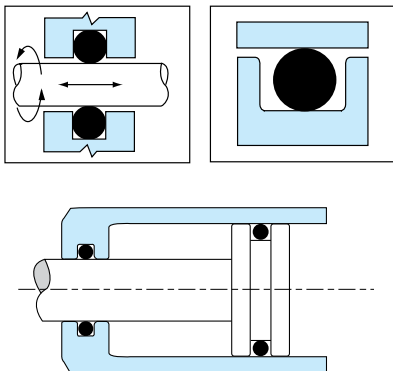

Fig. 1-33/34

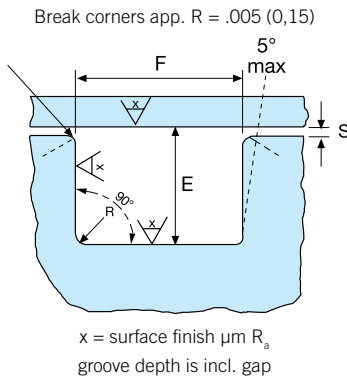

Fig. 1-27

Table 3.D-1 Gland Dimensions Dynamic Application-Industrial Reciprocating Seals, METRIC

W O-ring cross section Diam.		E Gland Depth in mm		S Diametr. Clearance	F Groove Width ** Tol. -0/+13	R Groove Radius	Max. Eccentricity
Tol. +/- ISO 3601-1B		Tol. -0/+					
0,90	0,08	0,72	0,02	0,1	1,20	0,2	0,05
1,0 - 1,02	0,08	0,80	0,02	0,1	1,35	0,2	0,05
1,20	0,08	0,96	0,02	0,1	1,60	0,2	0,05
1,25 - 1,27	0,08	1,00	0,02	0,1	1,70	0,2	0,05
1,42	0,08	1,13	0,02	0,1	1,90	0,2	0,05
1,50	0,08	1,20	0,02	0,1	2,00	0,2	0,05
1,60 - 1,63	0,08	1,28	0,03	0,1	2,10	0,2	0,05
1,78 - 1,80	0,08	1,42	0,03	0,1	2,40	0,2	0,05
1,90	0,08	1,52	0,03	0,1	2,50	0,2	0,05
2,0	0,08	1,60	0,04	0,1	2,65	0,2	0,05
2,20	0,09	1,89	0,04	0,1	3,00	0,2	0,05
2,40	0,09	2,06	0,04	0,1	3,25	0,2	0,05
2,46	0,09	2,11	0,04	0,1	3,35	0,2	0,05
2,50	0,09	2,15	0,04	0,1	3,40	0,2	0,05
2,65	0,09	2,25	0,04	0,1	3,55	0,2	0,05
2,70	0,09	2,32	0,04	0,1	3,70	0,2	0,05
2,95	0,09	2,53	0,04	0,1	4,00	0,5	0,05
3,0	0,09	2,61	0,04	0,15	4,05	0,5	0,07
3,15	0,09	2,74	0,05	0,15	4,25	0,5	0,07
3,55	0,10	3,07	0,05	0,15	4,75	0,5	0,07
3,60	0,10	3,13	0,05	0,15	4,85	0,5	0,07
4,0	0,10	3,48	0,05	0,15	5,40	0,5	0,07
4,50	0,10	3,99	0,05	0,15	6,00	0,5	0,07
4,70	0,13	4,17	0,05	0,15	6,30	0,5	0,07
4,80	0,13	4,26	0,05	0,15	6,40	0,5	0,07
5,0	0,13	4,44	0,05	0,15	6,70	0,7	0,10
5,30	0,13	4,73	0,05	0,15	7,15	0,7	0,10
5,50	0,13	4,88	0,05	0,15	7,40	0,7	0,10
5,70	0,13	5,06	0,05	0,15	7,60	0,7	0,10
5,80	0,13	5,15	0,05	0,15	7,75	0,7	0,10
6,0	0,13	5,19	0,05	0,18	8,15	0,7	0,13
6,40	0,15	5,54	0,05	0,18	8,70	0,7	0,13
6,50	0,15	5,63	0,05	0,18	8,85	0,7	0,13
6,90	0,15	5,97	0,05	0,18	9,40	0,7	0,13
6,99	0,15	6,05	0,05	0,18	9,50	0,7	0,13
7,0	0,15	6,06	0,05	0,18	9,55	0,7	0,13
7,50	0,15	6,49	0,05	0,18	10,20	1,0	0,13
8,0	0,15	6,92	0,05	0,18	10,90	1,0	0,13
8,40	0,15	7,27	0,05	0,18	11,45	1,0	0,13
9,0	0,2*	7,92	0,05	0,18	12,10	1,0	0,13
10,0	0,2*	8,80	0,05	0,18	13,40	1,0	0,13

\* Not defined in ISO 3601/1

\*\* For groove width with back-up rings for O-rings AS 568A, see table 3.D-2. For groove width with back-up rings for metric O-rings, ask for more information.

### 12. O-ring Gland Design

#### 12 F. Groove Design for Static and Dynamic Applications when using Back-up Rings

##### The use of Back-up rings

Extrusion occurs when part of the O-ring material is forced through the gap between mating metal parts because of system pressure.

##### Extrusion can be prevented in several ways:

- Reducing the gap will help prevent extrusion.
- A harder O-ring material i.e. NBR 90 Shore, FKM 90 or 95 Shore A, AU, EU, PUR (Polyurethane) can be used to prevent extrusion. (FKM 95° shore is also excellent for explosive decompression applications, see page 96).
- An O-ring can be installed with a back-up ring of a harder material to close the gap and support the O-ring.

The use of back-up rings is related to O-ring hardness, media pressure, and whether it is a static or dynamic application. In general the guidelines are:

##### Pressure static application:

up to 1000 psi (70 bar, 7 MPa) without back-up ring, up to 6000 psi (400 bar, 40 MPa) with back-up ring, up to 30000 psi (2000 bar, 200 MPa) with special construction.

##### Dynamic application:

reciprocating up to 750 psi (50 bar, 5MPa) without back-up ring, higher pressures with back-up ring.

##### Speed

reciprocating up to 0.5 m/sec.

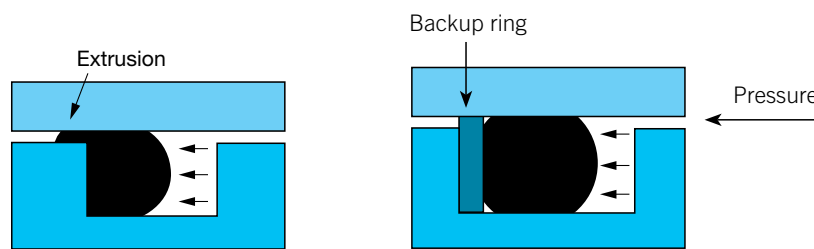
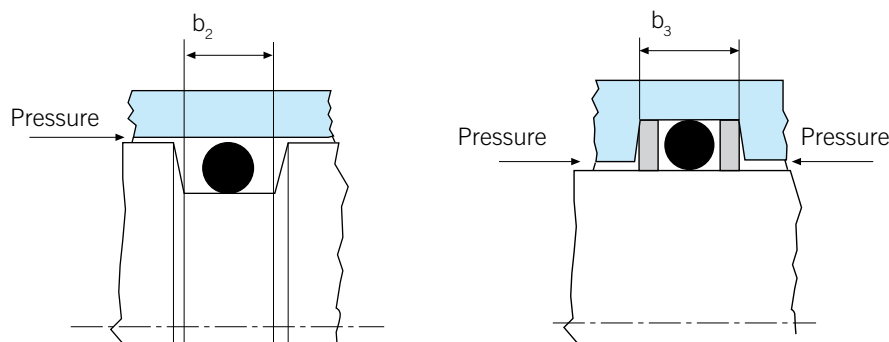
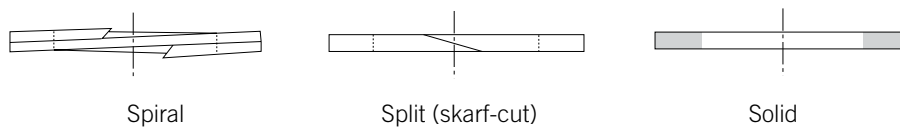

Fig. 1-38

#### Different shapes of Back-up rings:



### 12. O-ring Gland Design

#### Solution with Back-up Rings

In practice extrusion of a 70 Shore A O-ring at 20°C (70°F) with correct gland clearance, does not occur at pressures under 1200 psi (80 bar, 8 MPa) in static applications.

To avoid risks of extrusion, it is recommended to use 90 Shore A O-rings at pressures higher than 750 psi (50 bar, 5MPa) if the dimension of the groove is too small for back-up rings or if the groove cannot be machined to allow for back-up rings. In general it is recommended in dynamic applications to use back-up rings at pressures over 750 psi (50 bar, 5 MPa).

Back-up rings are generally made of a material that is harder than the O-ring material. Back-up rings can be made from PTFE and PTFE blends, 90-95 hardness elastomers, and some plastics such as polyamides or PEEK for high temperature applications. Back-up rings are installed down stream from the system pressure in the O-ring gland. See figure 22.

In double acting applications two back-up rings are installed, one on each side of the O-ring. When back-up rings are used the groove dimensions must be adapted to accommodate the back-up rings. Groove widths as indicated on the table should be increased by the thickness of the back-up ring or rings.

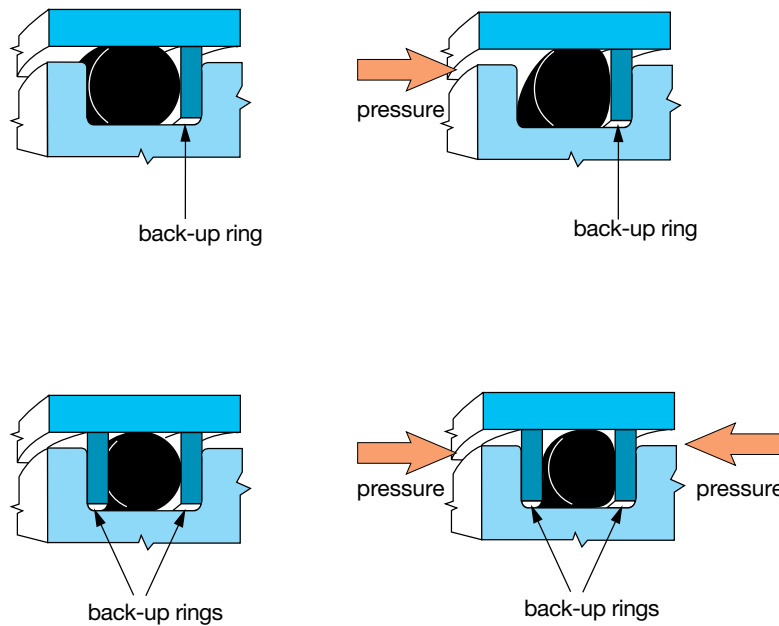

Fig. 1-22

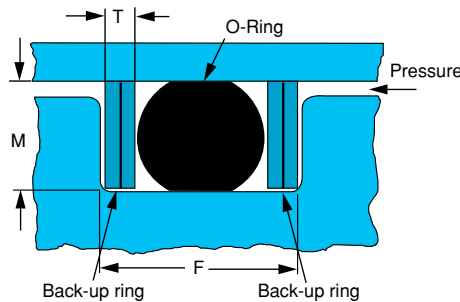

Fig. 1-35

### 12. O-ring Gland Design

#### Back-up Ring Styles

Spiral and split (or scarf-cut) PTFE back-up rings are a common choice due to the ease of installation of these designs. Note that the width of the back-up ring is equal to the groove depth plus the clearance gap. See figure 1-23.

The solid PTFE back-up ring is recommended for applications with higher system pressures; however, this design can only be installed in two piece applications.

Contoured nitrile back-up rings are recommended at higher system pressures where the ability to stretch the back-up in installation is required. See figure 1-24.

Standard dimensions for US Standard AS568 O-rings with back-ups are listed in table 3.D.-2.

PTFE back-up rings are available in custom dimensions. Please contact an ERIKS representative for assistance in groove design.

For US standard O-rings in accordance with AS568, standard spiral PTFE back-ups are available. See table 3.D-2 for groove dimensions for O-rings with standard back-ups. See figure 1-35.

#### Note:

We also stock the Parbak® back-up rings in different compounds of 90 Shore A, mainly in AS-dimensions.

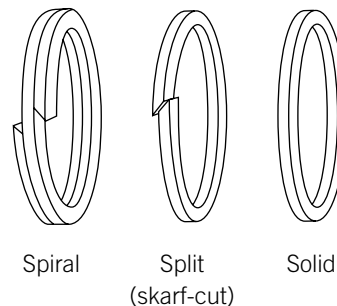

Fig. 1-23

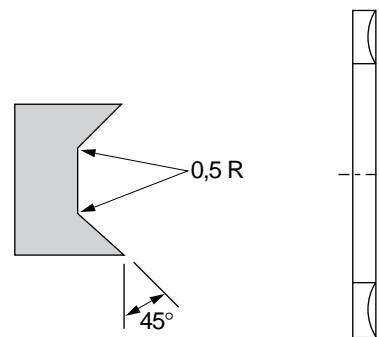

Fig. 1-24

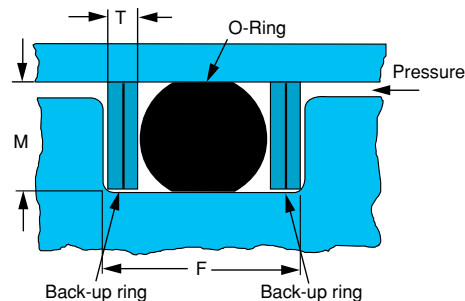

Fig. 1-35

Table 3.D-2 Groove Dimensions for O-rings with Standard Spiral Wound Back-up rings.

O-ring Cross Section W		Back-up ring Thickness T		Groove Depth (incl. clearance) M		Groove Width with 1 back-up ring F		Groove Width with 2 back-up rings F	
inch	mm	inch +0/-0.001	mm +0/-0,25	inch +0/-0.002	mm +0/-0,25	inch +0.004/-0	mm +0,1/-0	inch +0.004/-0	mm +0,1/-0
.070	1,78	.059	1,5	.057	1,45	.138	3,8	.209	5,3
.103	2,62	.059	1,5	.090	2,25	.197	5,0	.256	6,5
.139	3,53	.059	1,5	.123	3,10	.244	6,2	.303	7,7
.210	5,33	.071	1,8	.188	4,70	.350	8,9	.421	10,7
.275	6,99	.102	2,6	.238	6,05	.476	12,1	.579	14,7

### 12. O-ring Gland Design

#### PTFE BACK-UP RINGS Standard Sizes for O-rings according AS 568

The dimension 'E' of the back-up ring is dependent upon the depth of the groove for dynamic O-ring applications. The standard groove width needs to be increased with one or two times the width of the back-up ring depending if one or two back-up rings need to be installed. (See fig 1-39,1-40)

It is only needed to install a back-up ring at the side where the extrusion of the O-ring or Quad-Ring®/X-Ring exists. Only in the case of changing pressure directions are back-up rings needed on both sides of the seal. Standard back-up rings are available for O-rings according the table 3.D-2A.

Please ask an ERIKS back-up ring specialist for special sizes.

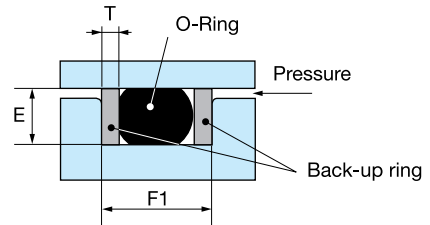

Fig. 1-39

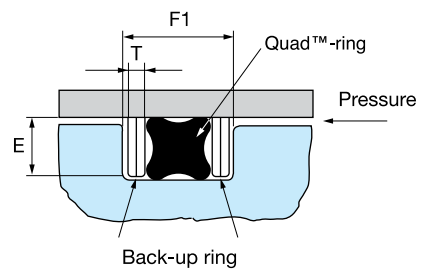

Fig. 1-40

### 12. O-ring Gland Design

#### 12 G. Gland design For Teflon® Encapsulated O-rings, Teflex O-rings

The Teflex O-ring consists of a solid or hollow elastomeric core encapsulated in a Teflon® FEP or PFA sheath. The elastomeric core may be fluorocarbon or silicon rubber.

Solid core Teflex O-rings are generally used in static applications. Hollow Silicone core Teflex O-rings are commonly used in applications where lower sealing force is required as in semi-dynamic applications.

The Teflex O-ring offers an effective solution for many difficult applications. The Teflon® FEP or PFA encapsulation actually effects the seal. The elastomeric core insures consistent compression on the seal. The result is an overall sealing compression, increasing with medium pressure. The encapsulated O-ring behaves like a highly viscous fluid, any pressure exerted on the seal is transmitted undiminished in all directions. FEP and PFA are suitable for injection molding. Maximum operating temperature for FEP is 205°C (400°F) and for PFA 260°C (500°F). Chemical and electrical properties are similar to PTFE. PFA offers additional abrasion resistance. (See fig.43).

#### Why are Teflex O-rings needed?

There are certain applications which prohibit the use of conventional rubber O-ring seals. The use of hostile chemicals or extreme temperatures (both high and low) during various processes can make effective sealing very difficult. Many seal manufacturers have produced different "high performance" materials for these applications. ERIKS contributed to this area by introducing Teflex.

The Teflex O-ring is available in several standard size ranges:

- AS 568, BS 1806
- JIS B2401
- Swedish Standard.
- Metric Dimensions.

Teflex O-rings are available in other dimensions and alternative cross sections, oval, square, rectangular. Contact an ERIKS representative for additional information. For full information: ask for the special brochure on Teflex O-rings.

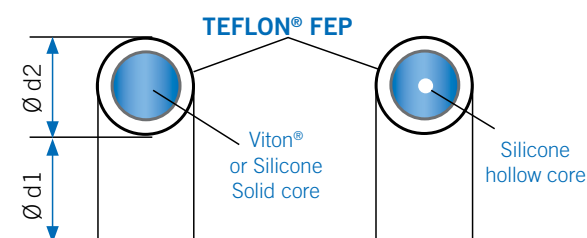

#### Teflex O-rings offer:

- Excellent chemical resistance due to the FEP/PFA encapsulation.
- Temperature range from -60°C to 205°C (-75°F to 400°F) with silicone core and -15°C to 205°C (5°F to 440°F) with fluorocarbon core. Special applications are possible up to 260°C (500°F).
- Overall hardness 85 Shore A ±5 durometer.
- Sterilizable.
- Pressures from vacuum to 10000 psi (700 bar, 70 MPa).
- Low compression set characteristics.
- Anti-adhesive properties, non stick surface, low coefficient of friction.
- FDA compliant
- Quick supply
- No restriction on inside diameter

Teflex O-rings are available in the following dimensions.

Upon request Teflex O-rings can also be supplied in a special design or dimensions.

Size range			
smallest inside Ø possible (in mm)			
Cord (mm)	Viton® Core	Silicone Core	Silicone/Viton® Hollow Core
1,60	10,00	5,00	not possible
1,78	10,00	5,28	8,0
2,00	10,00	6,80	10,00
2,50	12,00	7,40	12,00
2,62	12,00	7,60	16,00
3,00	15,00	12,00	20,00
3,40	15,00	12,50	23,00
3,53	15,00	13,00	24,00
4,00	16,00	14,00	28,00
4,25	17,00	14,50	32,00
4,50	18,00	15,00	35,00
5,00	22,00	20,00	42,00
5,33	25,00	22,00	48,00
5,50	27,00	23,00	50,00
5,70	27,00	24,00	60,00
6,00	30,00	27,00	75,00
6,35	40,00	40,00	90,00
6,99	50,00	50,00	100,00
8,00	75,00	75,00	150,00
8,40	80,00	80,00	160,00
9,00	100,00	100,00	175,00
9,52	120,00	105,00	200,00
10,00	140,00	110,00	230,00
11,10	150,00	115,00	250,00
12,00	180,00	120,00	300,00
12,70	190,00	130,00	350,00

There is no upper limit to inside diameters. Please refer to the design and installation section for housing details.

It is not recommend to stretch O-Rings smaller than 12 mm inside diameter. This often results in breakage of the core which is not vulcanised on small sizes.

### 12. O-ring Gland Design

#### 12 G. Gland design For Teflon® Encapsulated O-rings, Teflex O-rings

**Table 1 - Piston/Rod Sealing Application**

∅	't'	'b'
1.60	1.20	1.90
1.78	1.30	2.30
2.00	1.50	2.60
2.50	1.90	3.20
2.62	2.00	3.40
3.00	2.30	3.90
3.53	2.75	4.50
4.00	3.15	5.20
4.50	3.60	5.80
5.00	4.00	6.50
5.34	4.30	6.90
5.50	4.50	7.10
5.70	4.65	7.40
6.00	4.95	7.80
6.35	5.25	8.20
6.99	5.85	9.10
8.00	6.75	10.40
8.40	7.20	10.50
9.00	7.70	11.70
9.52	8.20	12.30
10.00	8.65	13.00
11.10	9.65	14.30
12.00	10.60	15.60
12.70	11.45	16.80

**Table 2 - Axial Face Sealing Application**

∅	't'	'b'
1.60	1.20 ± 0.05	2.10
1.78	1.30 ± 0.05	2.30
2.00	1.50 ± 0.05	2.60
2.50	1.90 ± 0.05	3.20
2.62	2.00 ± 0.05	3.40
3.00	2.30 ± 0.05	3.90
3.53	2.75 ± 0.05	4.50
4.00	3.15 ± 0.05	5.20
4.50	3.60 ± 0.05	5.80
5.00	4.00 ± 0.05	6.50
5.34	4.30 ± 0.05	6.90
5.50	4.50 ± 0.05	7.10
5.70	4.65 ± 0.05	7.40
6.00	4.95 ± 0.05	7.80
6.35	5.25 ± 0.05	8.20
6.99	5.85 ± 0.05	9.10
8.00	6.75 ± 0.10	10.40
8.40	7.15 ± 0.10	10.90
9.00	7.70 ± 0.10	11.70
9.52	8.20 ± 0.10	12.30
10.00	8.65 ± 0.10	13.00
11.10	9.70 ± 0.10	14.30
12.00	10.60 ± 0.10	15.60
12.70	11.40 ± 0.10	16.70

Table 1

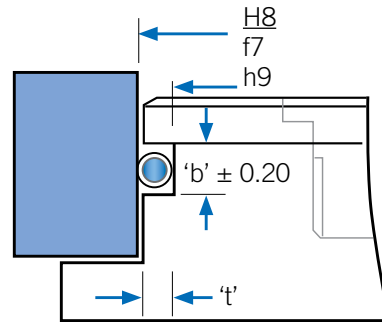

Table 1

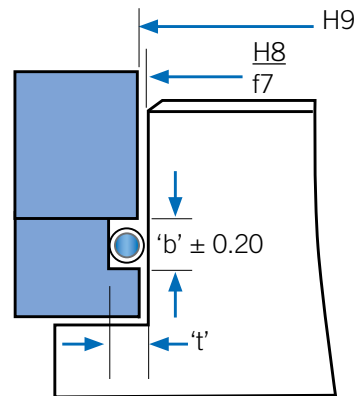
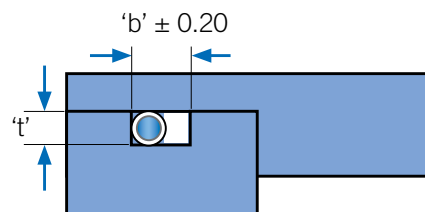

Table 2





## 12. O-ring Gland Design

### 12 G. Gland design For Teflon® Encapsulated O-rings, Teflex O-rings

#### Installation of Teflex O-rings

It is critical that the Teflex O-ring is not damaged during installation. It is not recommended to stretch Teflex O-rings. Break all sharp corners and lubricate the groove before installation. Take care not to bend the O-ring too sharply as buckling of the PTFE/FEP covering may result. The Teflex O-ring may be heated to make it slightly more flexible to facilitate installation. Teflex O-rings are subject to compression set. Smaller diameter cross section O-rings will demonstrate higher compression set than larger diameter cross sections. For this reason the use of the biggest possible cross section is recommended. ERIKS recommends the use of Teflex O-rings in static applications. For use in dynamic applications tests should be conducted for suitability.

#### Design

The following diagrams show the suggested adaptations of BS, ISO, and DIN standard housing designs.

The surface finish to all contact parts should be 20 micro- inch or better.

The following diagram gives tolerances for axial face sealing:

	Pressure
Seal Surface	Ra 0,4 – 0,8
	Rt 3- 6,3
Surface	Ra 1,6
	Rt 11- 16

### 12. O-ring Gland Design

#### 12 H. Gland Design for solid PTFE O-rings

PTFE has very poor elasticity. For this reason it is recommended that PTFE O-rings are only used in static applications with an axial load.

PTFE O-rings require much higher compression than elastomers to cause a seal. Rigidity of the material makes PTFE O-rings relatively difficult to install. Heating them to approximately 100°C (215°F) will make them slightly more flexible and facilitate easier installation. Perfluorinated elastomers have similar chemical resistance and thermal properties while offering the advantages of an elastomeric seal. In extreme or critical applications consideration of the use of a perfluorinated elastomer is recommended. (See fig. 1-45, 1-46, 1-47).

$E = 10\%$  to  $20\%$  of cross section (.070 to .210 inch) (1,78 to 5,33 mm).

$E = 10\%$  to  $15\%$  of cross section (.210 to .275 inch) (5,33 to 7 mm)

#### Surface Finish

groove top and bottom :

for liquids

$X = 32$  micro inches (0,8  $\mu\text{m}$  Ra).

for vacuum and gases

$X = 16$  micro inches (0,4  $\mu\text{m}$  Ra).

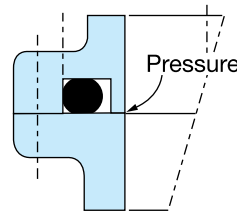

Fig. 1-45

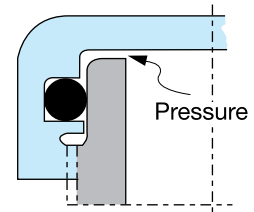

Fig. 1-46

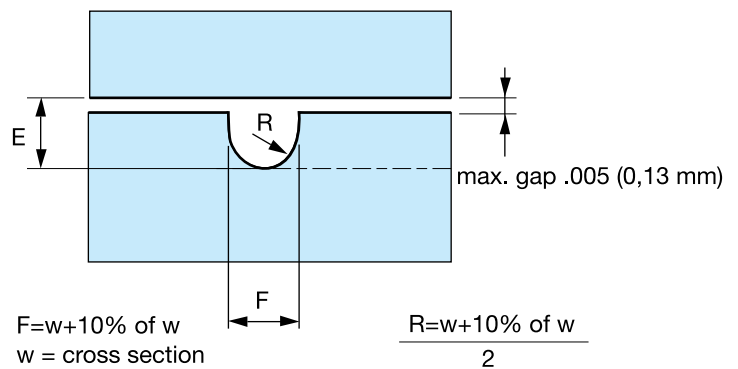
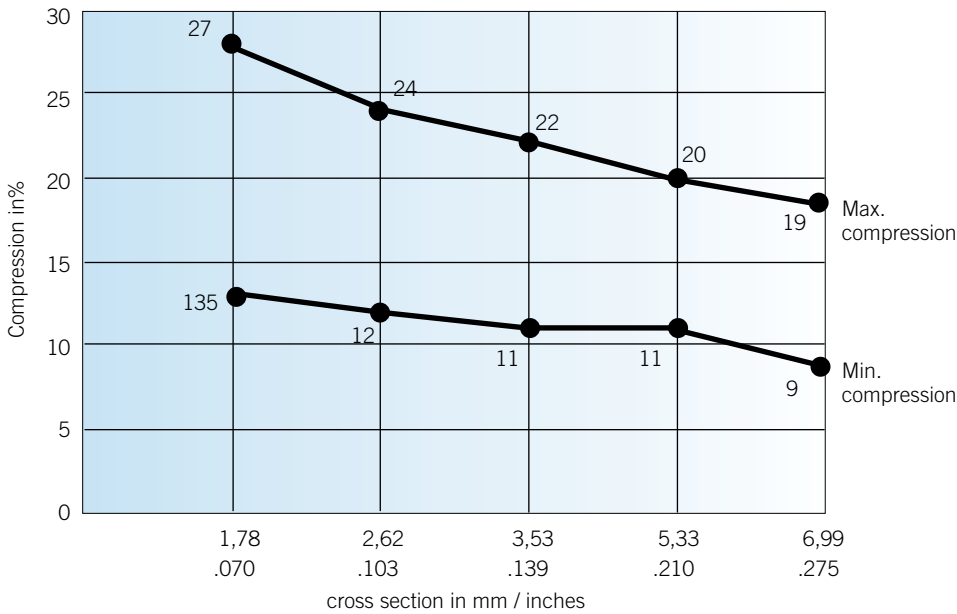

Fig. 1-47

### 12. O-ring Gland Design

#### 12 I. O-ring Compression in Different Applications

##### 1. Hydraulic Dynamic Applications



##### 2. Pneumatic Dynamic Applications

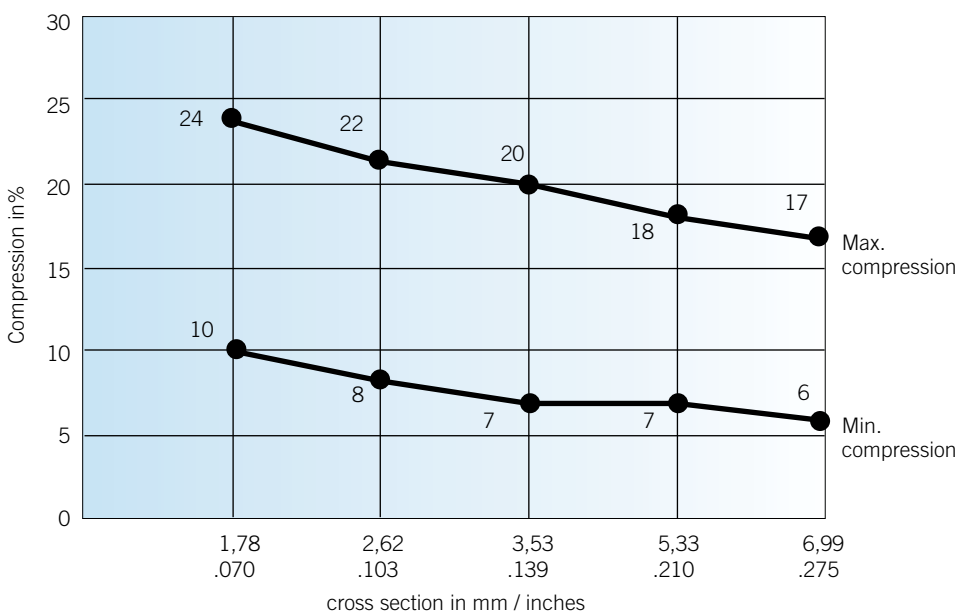

### 12. O-ring Gland Design

#### 12 I. O-ring Compression in Different Applications

##### 3. Hydraulic and Pneumatic Static Applications

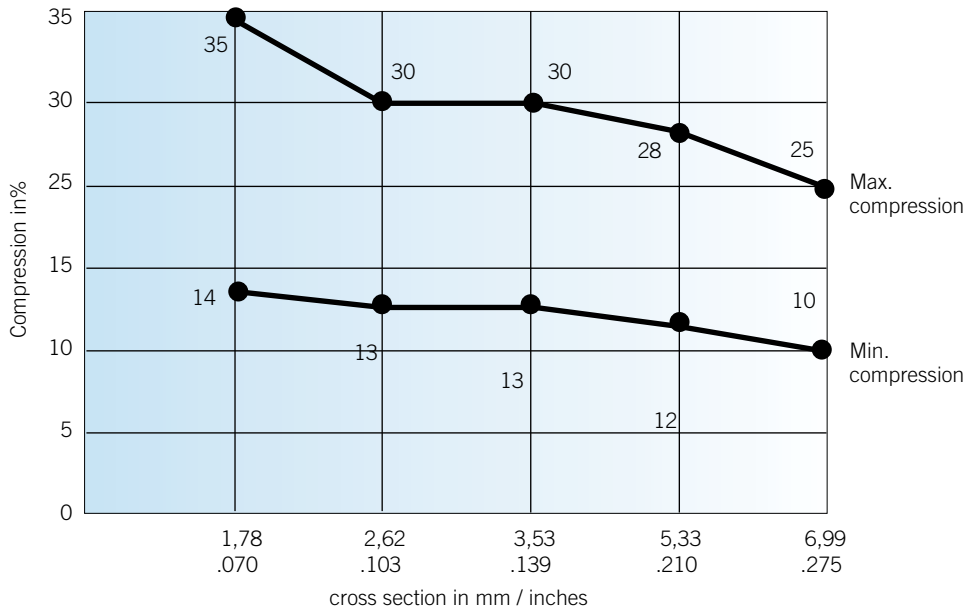

##### 4. Hydraulic and Pneumatic Axial (face seal) Applications

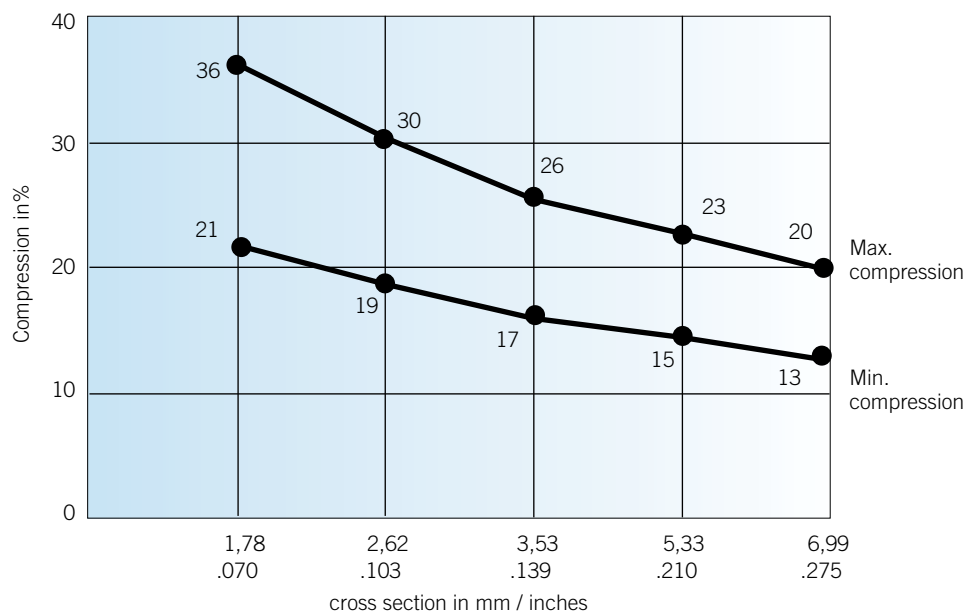

## 12. O-ring Gland Design

### 12 J. Gland design for Kalrez® O-rings

Kalrez® parts are manufactured from exceptionally stable materials which are serviceable in most chemical environments up to 327°C (620°F) (depending on the specific compound).

The purpose of this design guide is to provide engineers with guidance in the selection of O-rings and the design of grooves for specific applications. In non-aggressive media, at modest pressures and temperatures, there is usually little problem in developing a groove design or selecting an O-ring. In the case where the operating environment is more aggressive and the application is more specialized design problems may occur. The information provided is intended to facilitate the groove/seal design process, especially with Kalrez® perfluoroelastomer parts.

#### General considerations in seal selection or groove design

From a knowledge of the temperature and chemical media, a suitable sealing compound can be selected. To design a groove, or select the best O-ring size for a given groove, however, the application environment must be considered in more detail.

- What is the application temperature range?
- Is the temperature cyclic?
- What is the pressure differential and direction?
- If it is a vacuum application, where is the vacuum applied?
- Is the pressure or vacuum cyclic?
- What is the compression/decompression rate if the pressure is high (In excess of 80 bar)?
- Is it a radial seal (piston rod/housing type)?
- Is it a face seal (flange type)?
- Is it a standard groove section or is it non-standard: crush-type, dovetail-section?
- Is it a gasket application?
- What is the chemical media to be sealed?
- If it is a replacement for a failure, what was the old seal?
- What is the consequence of failure?
- Is the application static or dynamic?
- If it is dynamic, define the motion.
- What are the groove dimensions and tolerances if it is in existence?



### 12. O-ring Gland Design

#### 12 J. Gland design for Kalrez® O-rings

The ratio of the O-ring CSD to the groove depth will dictate the initial compression. There are some general rules for initial compression when using Kalrez® O-rings as given in these tables.

The condition in Table 1 represents the 'Normal Case' where the operating temperatures are not particularly aggressive and therefore the thermal expansion will not be excessive.

The scenario in Table 2 is the 'High Temperature' region. The application is now at a temperature in excess of that at which thermal expansion becomes significant. The volumetric thermal expansion for Kalrez® is 0% at 21°C and up to 20.42% at 316°C. Note that the effective squeeze will increase at high temperature as a result of this expansion.

In the scenario in Table 3 the O-ring dimensions actually reduce as the surrounding environment is changed from the assembly conditions to the operating conditions. The reduction in O-ring size is a result of low temperature shrinkage (may be regarded as a reversal of expansion), or the direct effect of vacuum. In either case, the initial squeeze may decrease significantly and it is necessary to compensate for this in the design stage.

In general, initial compression in excess of 25% is undesirable since it will cause over-compression at higher temperatures. In dynamic applications, high initial compression may cause problems associated with excessive friction.

Temperature cycling applications may require different squeezes.

**Table 1 Initial Squeeze for Applications Running at 25° to 200°C**

Cross section in mm	Initial Squeeze at 20°C (%)	
	Static	Dynamic
1,78	18	12
2,62	17,5	11,5
3,53	17	11
5,33	16,5	10,5
6,99	16	10

**Table 2 Initial Squeeze for Applications Running at > 200°C**

Cross section in mm	Initial Squeeze at 20°C (%)	
	Static	Dynamic
1,78	16	12
2,62	15,5	11,5
3,53	15	11
5,33	14,5	10,5
6,99	14	10

**Table 3 Initial Squeeze for Applications Running at Low Temperature & Vacuum**

Cross section in mm	Initial Squeeze at 20°C (%)	
	Static	Dynamic
1,78	27	20
2,62	25	18
3,53	23	16
5,33	21	14
6,99	19	12

### 12. O-ring Gland Design

#### 12 J. Gland design for Kalrez® O-rings

##### Compensating for thermal expansion effects

As stated before, one effect of thermal expansion is to cause the initial squeeze to increase. Another problem which may occur is over-filling of the O-ring groove as a result of the change in volume of the seal. In general, the groove should be designed according to the following expression:

$$\text{Volume}_{\text{GROOVE}} = \text{volume}_{\text{O-RING}} * (1 + C_{\text{EXP}} + T_{\text{EXP}})^* 1,2$$

where:

$C_{\text{EXP}}$  is the volumetric expansion due to chemical swell,

$T_{\text{EXP}}$  is the volumetric thermal expansion.

Please contact the local ERIKS representative for additional information



As a margin of safety, the groove should have a volume which is at least 20% larger than the fully expanded O-ring. The thermal expansion data for Kalrez® is given in Table 4.

**Table 4 Linear & Volumetric Expansion of Kalrez®**

Temperature in °C	Expansion (%)	
	Linear	Volumetric
21	0	0
38	0,41	1,24
93	1,68	5,04
149	2,96	8,90
204	4,23	12,79
260	5,50	16,56
316	6,81	20,42

If the effects of thermal expansion are not adequately considered, the O-ring will fill the groove and attempt to burst out of it, resulting in extrusion and catastrophic mechanical failure.

Additional swell may occur due to exposure to chemical media. Chemical swell data for Kalrez® is given in Appendix 1 of this document for many generic chemical classes. For data on specific chemicals and chemical mixtures it is usually necessary to perform swell tests. Much of this data from DuPont Performance Elastomers is available from an ERIKS representative.

##### Tolerance effects on groove design

Usually, when designing grooves, a standard (BS or AS) O-ring groove will be sufficient. However, in cases where swell and expansion are likely to be high it is often necessary to design a special groove. O-rings of small ID and relatively large CSD often cause problems. In these cases, the area bounded by the O-ring ID is small and it does not take much expansion to cause stretch and groove overfill problems. It is necessary to take great care when designing and tolerancing grooves for these classes of O-ring. It is possible to check for this sort of problem at the groove design stage, by comparing the extra O-ring volume due to swell with that available for swell, ensuring that the extremes of groove and seal tolerance are included in the calculation.

### 12. O-ring Gland Design

#### 12 J. Gland design for Kalrez® O-rings

##### Extrusion of O-rings in service

Extrusion is a common mode of failure and is often the result of inadequate consideration of expansion and swell. These problems are considered in the previous section “Compensating for thermal expansion effects”. It may be, however, that the maximum clearance gap (as defined by tolerances on joining surfaces) in the seal system has not been defined correctly.

The required maximum clearance gap in a seal is a function of the compound hardness and the pressure being sealed. Table 5 gives the required maximum clearance as a function of pressure and hardness if back-up rings are not used.

**Table 5 Maximum Clearance Gap vs Pressure/Hardness (mm)**

Maximum Pressure in bar	Hardness Shore A			
	60	70	80	90
7	0,7	0,79	0,84	0,86
15	0,56	0,66	0,73	0,79
20	0,43	0,56	0,66	0,73
30	0,36	0,48	0,58	0,68
35	0,28	0,40	0,51	0,64
40	0,20	0,36	0,48	0,61
50	0,15	0,31	0,43	0,56
55	0,13	0,25	0,38	0,53
60	0,10	0,23	0,36	0,51
70	0,08	0,20	0,33	0,48
140		0,05	0,15	0,28
200			0,08	0,15
275			0,02	0,10
345			0,01	0,05
410				0,04
480				0,025
550				0,02
620				0,01
700				0,00

As illustrated by this data, the softer compounds require closer tolerances than the harder compounds. It must be remembered that this data refers to relatively low temperature applications, up to 100°C. For high temperature applications it is necessary to consider the effect of temperature on the compound hardness. One rule of thumb is to assume a drop of hardness of about 10 (Shore A) for every 100°C temperature rise. Remember also that this clearance data is based on total diametral clearance.

It may not be feasible to machine to such close tolerances as required in some cases. Elastomers behave essentially as highly viscous incompressible fluids and tend to flow under the application of pressure and temperature.

The use of back-up rings is recommended if the pressure/temperature of the operating environment may cause the seal to flow. If, at a particular pressure, the maximum clearance gap is greater than the value specified in Table 5, a back-up ring should be used.

Back-up rings can be made from Teflon® fluoropolymer resin filled with 25% glass, or another material that is resistant to the environment being sealed. If a back-up ring is used, the groove should be modified to provide increased volume to avoid over filling at high temperatures.



### 12. O-ring Gland Design

#### 12 J. Gland design for Kalrez® O-rings

##### Compression set

Compression set is essentially a measure of a seal's ability to retain sealing force and, therefore, the capability to function. The degree of compression set will depend on the operating environment and, importantly, the duration of exposure. (It is typical in material datasheets to quote this property after 70 hrs exposure, which is hardly representative of long term performance. In fact, after an initial increase in compression set, Kalrez® tends to retain its elastomer properties much longer than conventional elastomers.

Compression set causes most problems in applications where thermal cycling is extreme. When continually exposed to very high temperatures, even Kalrez® will take on a cross sectional form which is no longer circular; This may not effect the seal integrity provided it is considered at the initial design stage. Kalrez® has a relatively slow elastic recovery rate. During thermal cycling, while the seal volume reduces due to temperature drop in the cooling phase, the form of the seal, taken during the high temperature phase, may be retained. At this time, the potential loss of sealing force will be at its greatest and the system may be prone to leakage. Such set is usually not permanent. The elastic recovery rate of Kalrez® increases rapidly with increasing temperature and if the seal temperature is raised, the normal circular cross section will return - along with the sealing properties.

It is evident, then, that the sequence of loading of a system can greatly influence the integrity of the seal. This is indicated by the following example loading sequence and the consequences on seal integrity:

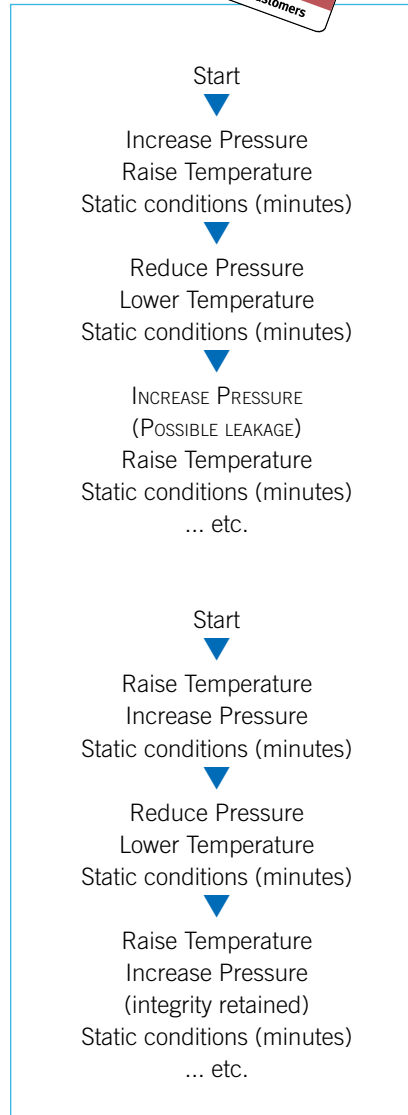
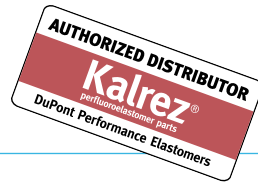

Simply by reversing the loading sequence seal leakage can be avoided.

Compression set is often accelerated by chemical attack - the total environment must be considered. Since the chemicals and chemical mixtures used in industry are so numerous, it is not feasible to either perform all test combinations or to present here all available data.

##### Installation of O-rings

A very important aspect of sealing is the installation of the seal. There are many ways to avoid damage to seal surfaces during assembly. The use of lubricants can minimize surface damage and, by reducing the coefficient of friction between seal and gland, allow easier sliding into position.

Since Kalrez® is resistant to almost all chemical media, almost any lubricant may be used. In fact, it is often easier to lubricate the seal with the chemical it is going to be sealing. Fluorinated oils such as Krytox® or powdered graphite can also be used to aid assembly. It is normal to design sealing systems such that the seal will not have to encounter any sharp edges during assembly. However, if this is not practical, it is simple to fabricate an assembly tool, often in the form of a cone, to help get the seal over many sharp edges.

The elongation at break for Kalrez® ranges from 120% to 170% depending on the compound being used. Remember when assembling that it is possible to break an O-ring by overstressing it. Since part of the molecular structure of Kalrez® is a material having plastic properties, it is also possible to cause plastic deformation due to overstressing. If you stretch Kalrez® too much, particularly when it is cold, it will first flow as a plastic and then fracture. For small CSD O-rings it is recommended that the stretch on assembly not exceed 20% to avoid these problems. Remember that O-rings can be softened by immersion in hot water prior to assembly.

Take note: if the O-ring is rolled into position be sure to not leave a permanent twist on the part. This may result in overstressing and mechanical failure at high temperature.

### 13. O-ring Assembling Conditions

#### Installation tips

The following instructions must be observed when installing O-rings:

Assembly must be done with care so that the O-ring is properly placed in the groove and is not damaged when the gland is closed.

- Always check the O-ring elastomer material first. Briefly check the cross section and inside diameter before installing the O-ring.
- Cleanliness is important for proper seal action and long O-ring life. Foreign particles in the gland may cause leakage and can damage the O-ring.
- Never glue the O-rings in the groove; there is a risk for chemical attack and hardening. An alternative is to use mounting grease. First, however, check the chemical compatibility.
- For problem free assembly of O-rings it is important that metal parts are rounded and free from sharp areas. Never force the O-ring over sharp threads, keyways, slots and other sharp edges.
- Do not use sharp tools, use an O-ring assembling aid to avoid damage.
- ID stretch as installed in a groove may not be more than 5-6%, because more stretch will reduce and flatten the cross section and thus reduce the squeeze.
- ID expansion to reach the groove during assembly should not exceed 50%. For very small diameters, it may be necessary to exceed this limit. If so, one should allow sufficient time for the O-ring to return to its normal size before closing the gland.
- Prevent the O-ring from being twisted. Twisting during installation may occur with O-rings having a large ratio of ID to cross section.
- Check the roughness of the counter surface.
- For removal of O-rings use an O-ring tool kit to prevent the metal surface or O-ring from being damaged.

#### For Cylinders:

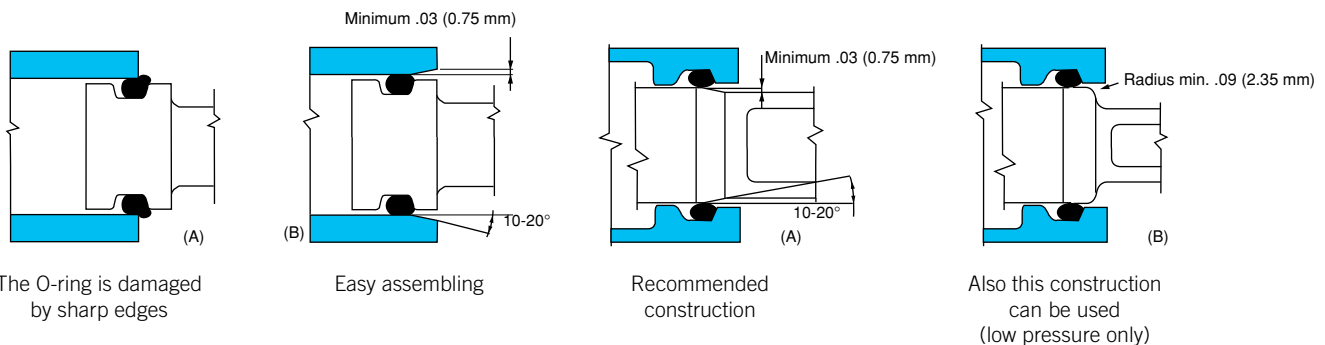

#### For Piston Seals

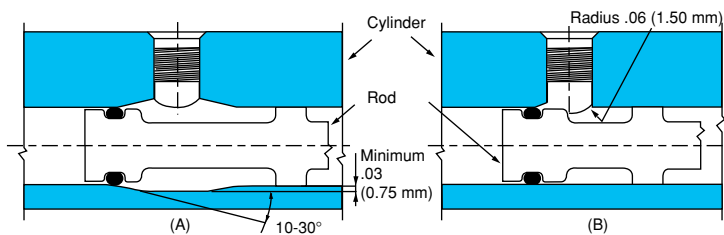

### 13. O-ring Assembling Conditions

#### Lubrication

For static and dynamic applications lubricated parts are important for ease of assembly. Silicone grease has to be used for lubricating EPDM.

Please bear in mind that silicone grease is not recommended for VMQ.

#### Compression Forces

The force required to compress an O-ring is related to the material compound, the hardness, the amount of squeeze, the cross section of the O-ring, and the temperature of the application. The anticipated load for a given installation is not fixed, but falls within a range of values.

The tables indicate approximate force requirements at 20°C (70°F) for different percentages of squeeze on 70 and 90 O-rings.

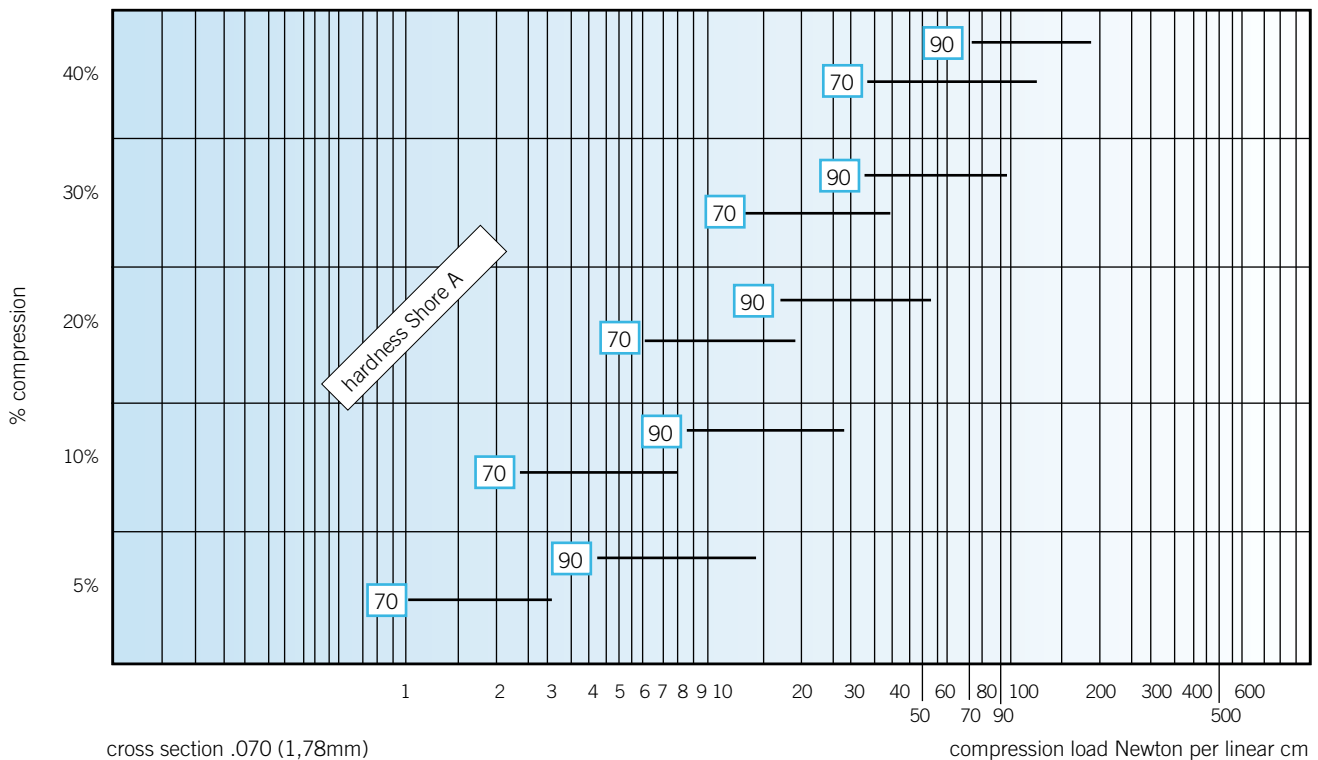

### 13. O-ring Assembling Conditions

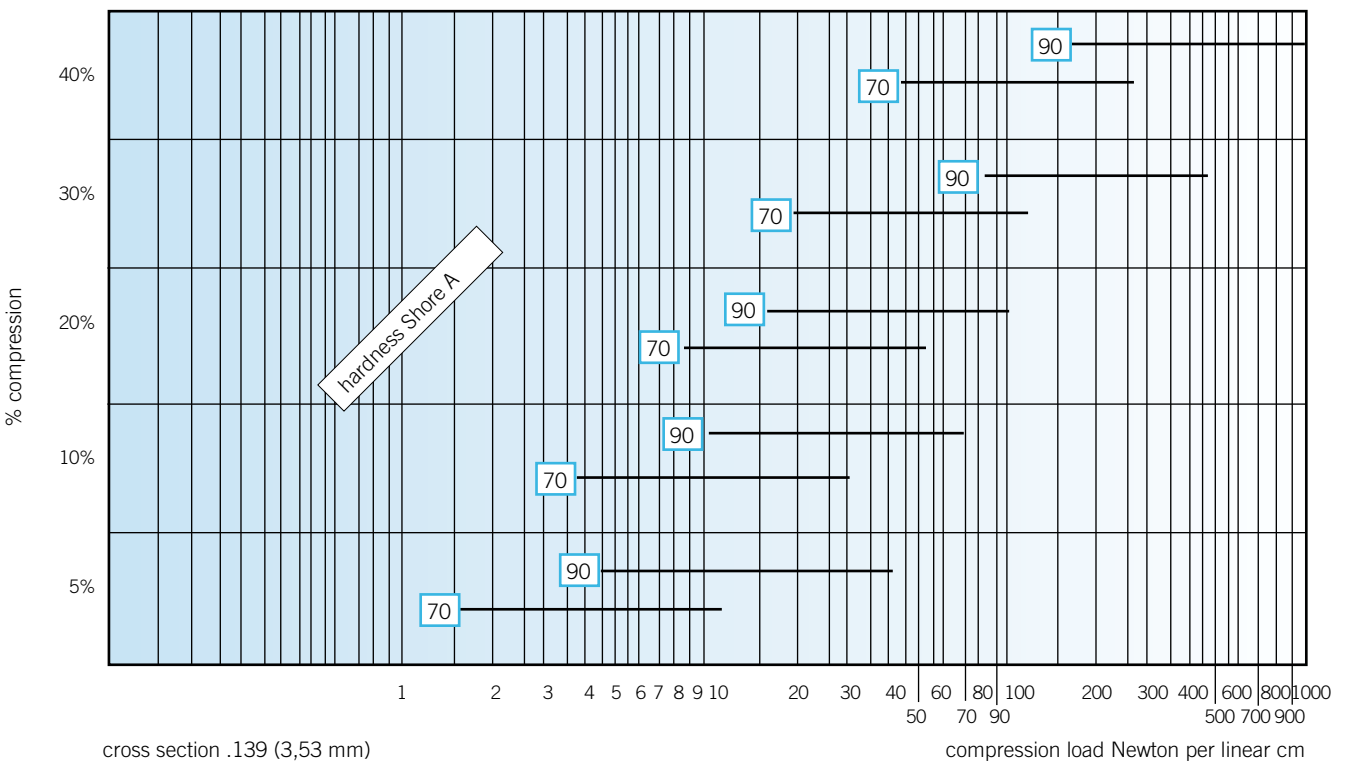
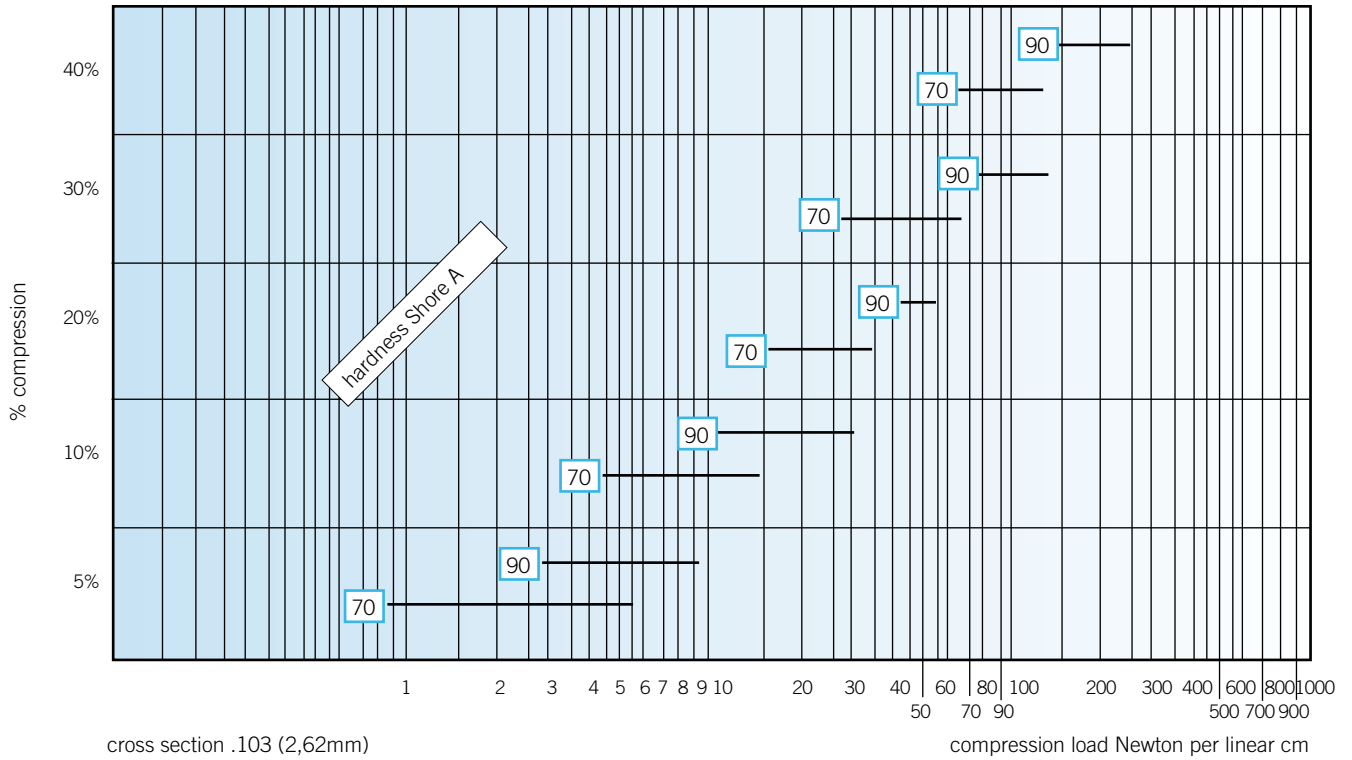

### 13. O-ring Assembling Conditions

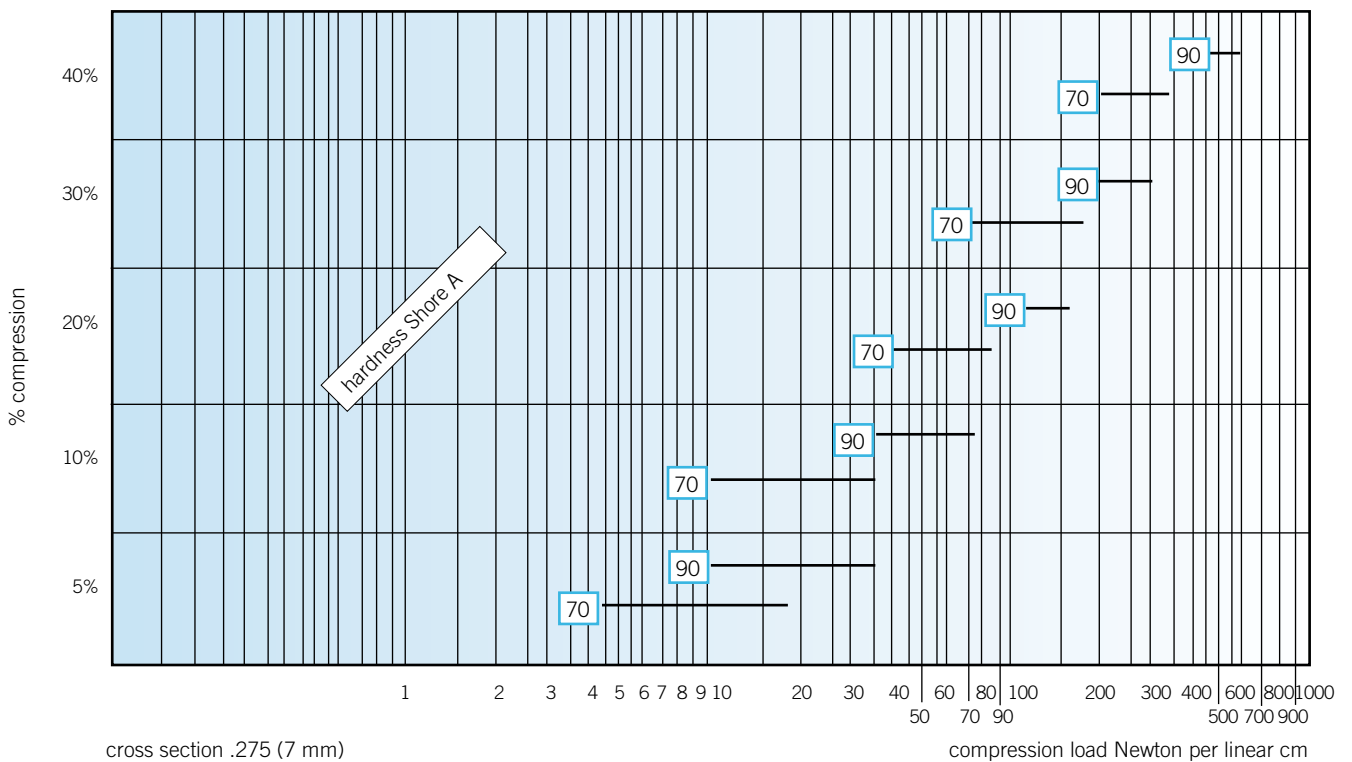
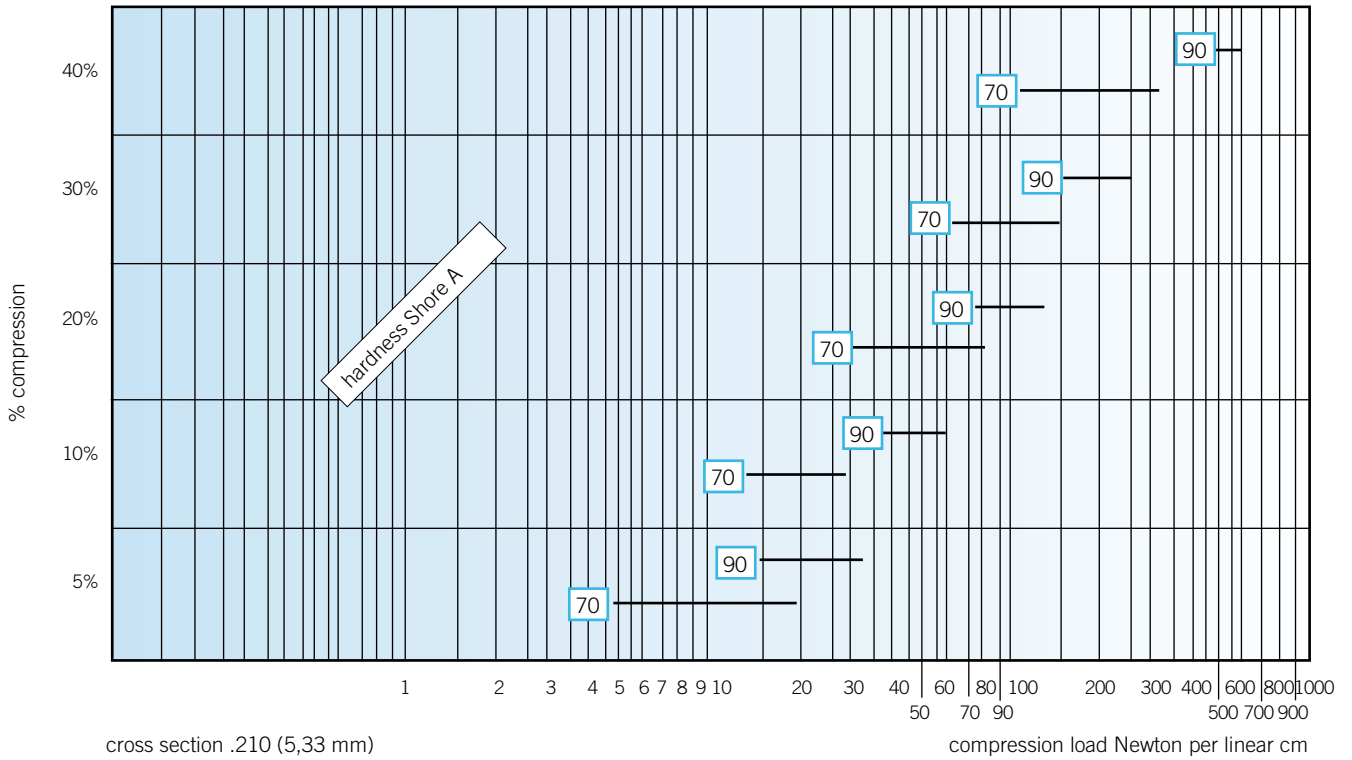

### 13. O-ring Assembling Conditions

#### Deforming Forces for O-rings

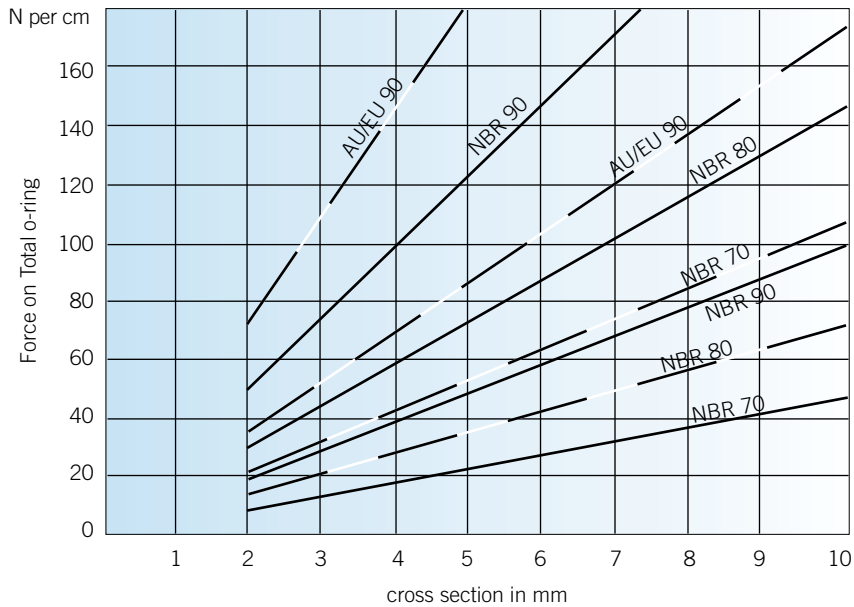

This graph indicates the deforming force to be used for different hardnesses and compounds.

#### How to Avoid Damage by O-ring Mounting

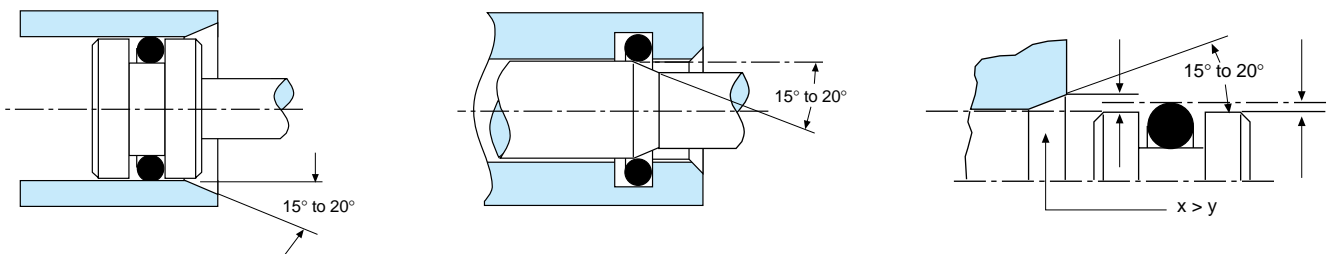

#### How to Avoid Sharp Edges

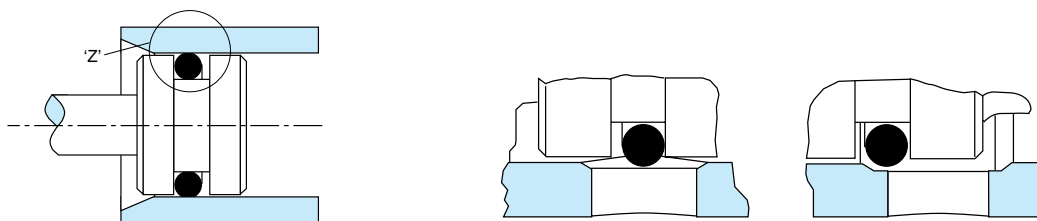

#### Use of Sleeve

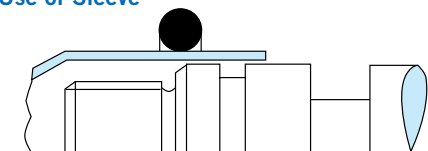

### 13. O-ring Assembling Conditions

#### Maximum stretch at Installation

The DIN 3771 Part 5 describes the maximum stretch of the O-ring inner diameter after installation.

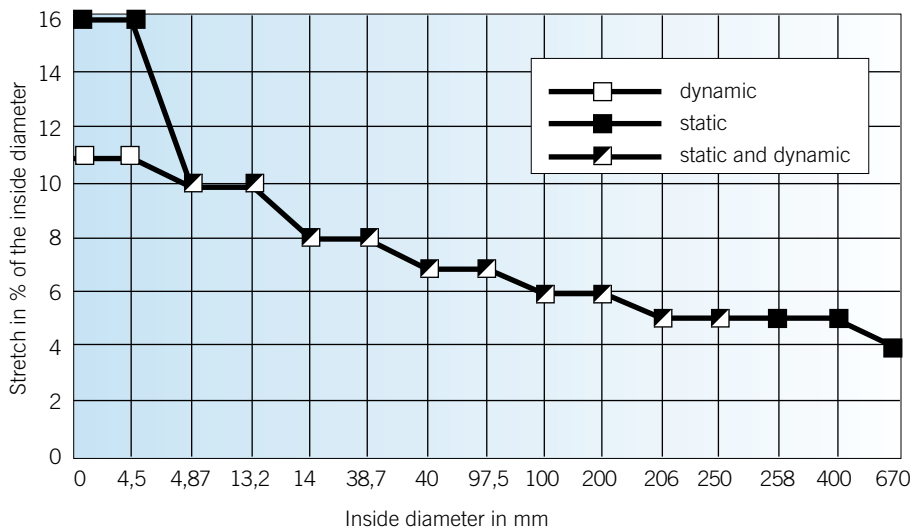

#### Surface Roughness

The surface roughness is an important factor when determining the life of an O-ring. Our experience suggests the following roughnesses:

Gases:

contact surface:  $R_a < 0,4 \mu\text{m}$   
 non contact surface:  $R_a < 1,6 \mu\text{m}$

Fluids:

contact surface:  $R_a < 0,8 \mu\text{m}$   
 non contact surface:  $R_a < 1,6 \mu\text{m}$

Vacuum:

contact surface :  $R_a < 0,4 \mu\text{m}$   
 non contact surface:  $R_a < 1,6 \mu\text{m}$

### 13. O-ring Assembling Conditions

#### Stretch or squeeze for O-ring I.D.

An O-ring that is too small may be stretched slightly for installation. This stretch results in some reduction of the cross section diameter of the O-ring material. Figure 25 indicates the approximate percentage the cross section decreases at given stretch percentages. This information should be taken into consideration when designing the groove.

Likewise, an O-ring that is too large may be compressed to fit the groove. Compression should not exceed 3% of the O-ring diameter. Stretch for a smaller O-ring should not exceed 5%.

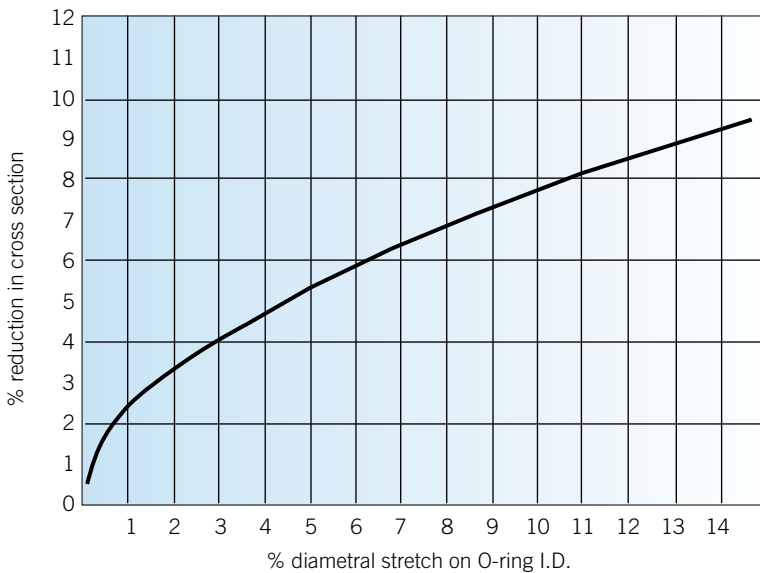

Fig. 1-25



### 14. O-ring Size Charts

The following tables list approximately 2000 O-ring sizes in order by inside diameter. These O-ring sizes correspond to US Standard AS568, British Standard, Swedish, as well as many common metric sizes according to DIN and ISO standards. Most of these sizes are readily available from ERIKS stock in:

- Nitrile NBR 70 and 90 Shore A,
- Fluoroelastomer FKM (Viton®) 75 and 90 Shore A,
- Perfluoroelastomer FFKM (Kalrez®) 75 Shore A,
- Ethylene-propylene EP, EPDM 70° Shore A,
- Silicone VMQ 70 Shore A,
- PTFE (virgin teflon),
- Teflex FEP/Viton®
- Teflex FEP/VMQ

The list of standards is continually being expanded. Please contact the nearest ERIKS representative for sizes not indicated here.

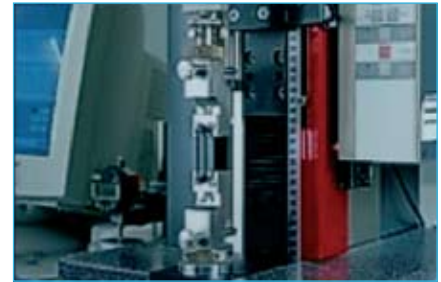

#### Standards in Different Countries

Norm	Cross Section (mm)					
	1,78	2,62	3,53	5,33	6,99	
AS 568A, BS 1806	1,78	2,62	3,53	5,33	6,99	
DIN 3771 / ISO3601	1,80	2,65	3,55	5,30	7,00	
SMS 1586, BS 4518	1,60	2,40	3,00	5,70	8,40	
Japanese Norm JIS B 2401	1,60	1,90	2,40	3,00	5,70	8,40
Metric	1,00	1,50	2,00	2,50	3,00	5,00
	10,00	12,00				

The different section diameters are due to the standards in different countries.

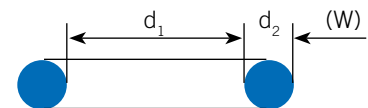

#### Note:

The AS O-ring Size Chart has a column that shows the Nominal Size alongside the Actual Size. Originally the nominal size was just for a listing of the approximate fractional dimensions of the O-ring. Prior to the common use of dial calipers many people called out a 1 inch by 1-1/4 in O-ring, this was a dash -214 O-ring. They used to also use these fractional dimensions as the gland size. So, the nominal size is in fact based on the gland size and not the O-ring size.

### 14. A. Standard O-ring Sizes

Standard O-ring Sizes (000 Series 004 to 050 cross section Diameters  $w = .070 \pm .003$  inches,  $w = 1,78 \pm 0,08$  mm)

Size Only AS 568A Uniform Dash No.	Nominal Size (Inches)			Standard O-ring Size (Inches)			Metric O-ring Size (millimeters)		
	I.D.	O.D.	W.	Actual	Per AS 568 A	W	Actual	Per AS 568A	W
-001*	1/32	3/32	1/32	.029	.004	.040	0,74	0,10	1,02
-002*	3/64	9/64	3/64	.042	.004	.050	1,07	0,10	1,27
-003*	1/16	3/16	1/16	.056	.004	.060	1,42	0,10	1,52
-004	5/64	13/64	1/16	.070	.005	.070	1,78	0,13	1,78
-005	3/32	7/32	1/16	.101	.005	.070	2,57	0,13	1,78
-006	1/8	1/4	1/16	.114	.005	.070	2,90	0,13	1,78
-007	5/32	9/32	1/16	.145	.005	.070	3,68	0,13	1,78
-008	3/16	5/16	1/16	.176	.005	.070	4,47	0,13	1,78
-009	7/32	11/32	1/16	.208	.005	.070	5,28	0,13	1,78
-010	1/4	3/8	1/16	.239	.005	.070	6,07	0,13	1,78
-011	5/16	7/16	1/16	.301	.005	.070	7,65	0,13	1,78
-012	3/8	1/2	1/16	.364	.005	.070	9,25	0,13	1,78
-013	7/16	9/16	1/16	.426	.005	.070	10,82	0,13	1,78
-014	1/2	5/8	1/16	.489	.005	.070	12,42	0,13	1,78
-015	9/16	11/16	1/16	.551	.007	.070	14,00	0,18	1,78
-016	5/8	3/4	1/16	.614	.009	.070	15,60	0,23	1,78
-017	11/16	13/16	1/16	.676	.009	.070	17,17	0,23	1,78
-018	3/4	7/8	1/16	.739	.009	.070	18,77	0,23	1,78
-019	13/16	15/16	1/16	.801	.009	.070	20,35	0,23	1,78
-020	7/8	1	1/16	.864	.009	.070	21,95	0,23	1,78
-021	15/16	1- 1/16	1/16	.926	.009	.070	23,52	0,23	1,78
-022	1	1/8	1/16	.989	.010	.070	25,12	0,25	1,78
-023	1- 1/16	1- 3/16	1/16	1.051	.010	.070	26,70	0,25	1,78
-024	1- 1/8	1- 1/4	1/16	1.114	.010	.070	28,30	0,25	1,78
-025	1- 3/16	1- 5/16	1/16	1.176	.011	.070	29,87	0,28	1,78
-026	1- 1/4	1- 3/8	1/16	1.239	.011	.070	31,47	0,28	1,78
-027	1- 5/16	1- 7/16	1/16	1.301	.011	.070	33,05	0,28	1,78
-028	1- 3/8	1- 1/2	1/16	1.364	.013	.070	34,65	0,33	1,78
-029	1- 1/2	1- 5/8	1/16	1.489	.013	.070	37,82	0,33	1,78
-030	1- 5/8	1- 3/4	1/16	1.614	.013	.070	41,00	0,33	1,78
-031	1- 3/4	1- 7/8	1/16	1.739	.015	.070	44,17	0,38	1,78
-032	1- 7/8	2	1/16	1.864	.015	.070	47,35	0,38	1,78
-033	2	2- 1/8	1/16	1.989	.018	.070	50,52	0,46	1,78
-034	2- 1/8	2- 1/4	1/16	2.114	.018	.070	53,70	0,46	1,78
-035	2- 1/4	2- 3/8	1/16	2.239	.018	.070	56,87	0,46	1,78
-036	2- 3/8	2- 1/2	1/16	2.364	.018	.070	60,05	0,46	1,78
-037	2- 1/2	2- 5/8	1/16	2.489	.018	.070	63,22	0,46	1,78
-038	2- 5/8	2- 3/4	1/16	2.614	.020	.070	66,40	0,51	1,78
-039	2- 3/4	2- 7/8	1/16	2.739	.020	.070	69,57	0,51	1,78
-040	2- 7/8	3	1/16	2.864	.020	.070	72,75	0,51	1,78
-041	3	3- 1/8	1/16	2.989	.024	.070	75,92	0,61	1,78
-042	3- 1/4	3- 3/8	1/16	3.239	.024	.070	82,27	0,61	1,78
-043	3- 1/2	3- 5/8	1/16	3.489	.024	.070	88,62	0,61	1,78
-044	3- 3/4	3- 7/8	1/16	3.739	.027	.070	94,97	0,69	1,78
-045	4	4- 1/8	1/16	3.989	.027	.070	101,32	0,69	1,78
-046	4- 1/4	4- 3/8	1/16	4.239	.030	.070	107,67	0,76	1,78
-047	4- 1/2	4- 5/8	1/16	4.489	.030	.070	114,02	0,76	1,78
-048	4- 3/4	4- 7/8	1/16	4.739	.030	.070	120,37	0,76	1,78
-049	5	5- 1/8	1/16	4.989	.037	.070	126,72	0,94	1,78
-050	5- 1/4	5- 3/8	1/16	5.239	.037	.070	133,07	0,94	1,78

(\*) cross section: 001  $w = .040 \pm .003$  inches.  $w = 1.02 \pm 0,08$  mm  
 002  $w = .050 \pm .003$  inches.  $w = 1.27 \pm 0,08$  mm  
 003  $w = .060 \pm .003$  inches.  $w = 1.52 \pm 0,08$  mm

### 14. A. Standard O-ring Sizes

**Standard O-ring Sizes (100 Series 102 to 178 cross section Diameters  $w = .103 \pm .003$  inches,  $w = 2,62 \pm 0,08$  mm)**

Size Only	Nominal Size (Inches)			Standard O-ring Size (Inches)			Metric O-ring Size (millimeters)		
				Actual	Per AS 568 A		Actual	Per AS 568A	
AS 568A Uniform									
Dash No.	I.D.	O.D.	W.	I.D.	Tol. +/-	W	I.D.	Tol. +/-	W
-102	1/16	1/4	3/32	.049	.005	.103	1,24	0,13	2,62
-103	3/32	9/32	3/32	.081	.005	.103	2,06	0,13	2,62
-104	1/8	5/16	3/32	.112	.005	.103	2,84	0,13	2,62
-105	5/32	11/32	3/32	.143	.005	.103	3,63	0,13	2,62
-106	3/16	3/8	3/32	.174	.005	.103	4,42	0,13	2,62
-107	7/32	13/32	3/32	.206	.005	.103	5,23	0,13	2,62
-108	1/4	7/16	3/32	.237	.005	.103	6,02	0,13	2,62
-109	5/16	1/2	3/32	.299	.005	.103	7,59	0,13	2,62
-110	3/8	9/16	3/32	.362	.005	.103	9,19	0,13	2,62
-111	7/16	5/8	3/32	.424	.005	.103	10,77	0,13	2,62
-112	1/2	11/16	3/32	.487	.005	.103	12,37	0,13	2,62
-113	9/16	3/4	3/32	.549	.007	.103	13,94	0,18	2,62
-114	5/8	13/16	3/32	.612	.009	.103	15,54	0,23	2,62
-115	11/16	7/8	3/32	.674	.009	.103	17,12	0,23	2,62
-116	3/4	15/16	3/32	.737	.009	.103	18,72	0,23	2,62
-117	13/16	1	3/32	.799	.010	.103	20,30	0,25	2,62
-118	7/8	1- 1/16	3/32	.862	.010	.103	21,89	0,25	2,62
-119	15/16	1- 1/8	3/32	.924	.010	.103	23,47	0,25	2,62
.120	1	1- 3/16	3/32	.987	.010	.103	25,07	0,25	2,62
-121	1- 1/16	1- 1/4	3/32	1.049	.010	.103	26,64	0,25	2,62
-122	1- 1/8	1- 5/16	3/32	1.112	.010	.103	28,24	0,25	2,62
-123	1- 3/16	1- 3/8	3/32	1.174	.012	.103	29,82	0,30	2,62
-124	1- 1/4	1- 7/16	3/32	1.237	.012	.103	31,42	0,30	2,62
-125	1- 5/16	1- 1/2	3/32	1.299	.012	.103	32,99	0,30	2,62
-126	1- 3/8	1- 9/16	3/32	1.362	.012	.103	34,59	0,30	2,62
-127	1- 7/16	1- 5/8	3/32	1.424	.012	.103	36,17	0,30	2,62
-128	1- 1/2	1- 11/16	3/32	1.487	.012	.103	37,77	0,30	2,62
-129	1- 9/16	1- 3/4	3/32	1.549	.015	.103	39,34	0,38	2,62
-130	1- 5/8	1- 13/16	3/32	1.612	.015	.103	40,94	0,38	2,62
-131	1- 11/16	1- 7/8	3/32	1.674	.015	.103	42,52	0,38	2,62
-132	1- 3/4	1- 15/16	3/32	1.737	.015	.103	44,12	0,38	2,62
-133	1- 13/16	2	3/32	1.799	.015	.103	45,69	0,38	2,62
-134	1- 7/8	2- 1/16	3/32	1.862	.015	.103	47,29	0,38	2,62
-135	1- 15/16	2- 1/8	3/32	1.925	.017	.103	48,90	0,43	2,62
-136	2	2- 3/16	3/32	1.987	.017	.103	50,47	0,43	2,62
-137	2- 1/16	2- 1/4	3/32	2.050	.017	.103	52,07	0,43	2,62
-138	2- 1/8	2- 5/16	3/32	2.112	.017	.103	53,64	0,43	2,62
-139	2- 3/16	2- 3/8	3/32	2.175	.017	.103	55,25	0,43	2,62
-140	2- 1/4	2- 7/16	3/32	2.237	.017	.103	56,82	0,43	2,62
-141	2- 5/16	2- 1/2	3/32	2.300	.020	.103	58,42	0,51	2,62
-142	2- 3/8	2- 9/16	3/32	2.362	.020	.103	59,99	0,51	2,62
-143	2- 7/16	2- 5/8	3/32	2.425	.020	.103	61,60	0,51	2,62
-144	2- 1/2	2- 11/16	3/32	2.487	.020	.103	63,17	0,51	2,62
-145	2- 9/16	2- 3/4	3/32	2.550	.020	.103	64,77	0,51	2,62

### 14. A. Standard O-ring Sizes

**Standard O-ring Sizes (100 Series 102 to 178 cross section Diameters  $w = .103 \pm .003$  inches,  $w = 2,62 \pm 0,08$  mm)**

Size Only	Nominal Size (Inches)			Standard O-ring Size (Inches)			Metric O-ring Size (millimeters)		
				Actual	Per AS 568 A				
AS 568A Uniform									
Dash No.	I.D.	O.D.	W.	I.D.	Tol. +/-	W	I.D.	Tol. +/-	W
-146	2- 5/8	2- 13/16	3/32	2.612	.020	.103	66,34	0,51	2,62
-147	2- 11/16	2- 7/8	3/32	2.675	.022	.103	67,95	0,56	2,62
-148	2- 3/4	2- 15/16	3/32	2.737	.022	.103	69,52	0,56	2,62
-149	2- 13/16	3	3/32	2.800	.022	.103	71,12	0,56	2,62
-150	2- 7/8	3- 1/16	3/32	2.862	.022	.103	72,69	0,56	2,62
-151	3	3- 3/16	3/32	2.987	.024	.103	75,87	0,61	2,62
-152	3- 1/4	3- 7/16	3/32	3.237	.024	.103	82,22	0,61	2,62
-153	3- 1/2	3- 11/16	3/32	3.487	.024	.103	88,57	0,61	2,62
-154	3- 3/4	3- 15/16	3/32	3.737	.028	.103	94,92	0,71	2,62
-155	4	4- 3/16	3/32	3.987	.028	.103	101,27	0,71	2,62
-156	4- 1/4	4- 7/16	3/32	4.237	.030	.103	107,62	0,76	2,62
-157	4- 1/2	4- 11/16	3/32	4.487	.030	.103	113,97	0,76	2,62
-158	4- 3/4	4- 15/16	3/32	4.737	.030	.103	120,32	0,76	2,62
-159	5	5- 3/16	3/32	4.987	.035	.103	126,67	0,89	2,62
-160	5- 1/4	5- 7/16	3/32	5.237	.035	.103	133,02	0,89	2,62
-161	5- 1/2	5- 11/16	3/32	5.487	.035	.103	139,37	0,89	2,62
-162	5- 3/4	5- 15/16	3/32	5.737	.035	.103	145,72	0,89	2,62
-163	6	6- 3/16	3/32	5.987	.035	.103	152,07	0,89	2,62
-164	6- 1/4	6- 7/16	3/32	6.237	.040	.103	158,42	1,02	2,62
-165	6- 1/2	6- 11/16	3/32	6.487	.040	.103	164,77	1,02	2,62
-166	6- 3/4	6- 15/16	3/32	6.737	.040	.103	171,12	1,02	2,62
-167	7	7- 3/16	3/32	6.987	.040	.103	177,47	1,02	2,62
-168	7- 1/4	7- 7/16	3/32	7.237	.045	.103	183,82	1,14	2,62
-169	7- 1/2	7- 11/16	3/32	7.487	.045	.103	190,17	1,14	2,62
-170	7- 3/4	7- 15/16	3/32	7.737	.045	.103	196,52	1,14	2,62
-171	8	8- 3/16	3/32	7.987	.045	.103	202,87	1,14	2,62
-172	8- 1/4	8- 7/16	3/32	8.237	.050	.103	209,22	1,27	2,62
-173	8- 1/2	8- 11/16	3/32	8.487	.050	.103	215,57	1,27	2,62
-174	8- 3/4	8- 15/16	3/32	8.737	.050	.103	221,92	1,27	2,62
-175	9	9- 3/16	3/32	8.987	.050	.103	228,27	1,27	2,62
-176	9- 1/4	9- 7/16	3/32	9.237	.055	.103	234,62	1,40	2,62
-177	9- 1/2	9- 11/16	3/32	9.487	.055	.103	240,97	1,40	2,62
-178	9- 3/4	9- 15/16	3/32	9.737	.055	.103	247,32	1,40	2,62

### 14. A. Standard O-ring Sizes

**Standard O-ring Sizes (200 Series 201 to 285 cross section Diameters w = 139 ± .004 inches, w = 3,53 ± 0,10 mm)**

Size Only	Nominal Size (Inches)			Standard O-ring Size (Inches)			Metric O-ring Size (millimeters)		
				Actual	Per AS 568 A				
AS 568A Uniform				Actual	Per AS 568 A		Actual	Per AS 568A	
Dash No.	I.D.	O.D.	W.	I.D.	Tol. +/-	W	I.D.	Tol. +/-	W
-201	3/16	7/16	1/8	.171	.055	.139	4,34	0,13	3,53
-202	1/4	1/2	1/8	.234	.005	.139	5,94	0,13	3,53
-203	5/16	9/16	1/8	.296	.005	.139	7,52	0,13	3,53
-204	3/8	5/8	1/8	.359	.005	.139	9,12	0,13	3,53
-205	7/16	11/16	1/8	.421	.005	.139	10,69	0,13	3,53
-206	1/2	3/4	1/8	.484	.005	.139	12,29	0,13	3,53
-207	9/16	13/16	1/8	.546	.007	.139	13,87	0,18	3,53
-208	5/8	7/8	1/8	.609	.009	.139	15,47	0,23	3,53
-209	11/16	15/16	1/8	.671	.010	.139	17,04	0,23	3,53
-210	3/4	1	1/8	.734	.010	.139	18,64	0,25	3,53
-211	13/16	1- 1/16	1/8	.796	.010	.139	20,22	0,25	3,53
-212	7/8	1- 1/8	1/8	.859	.010	.139	21,82	0,25	3,53
-213	15/16	1- 3/16	1/8	.921	.010	.139	23,39	0,25	3,53
-214	1	1- 1/4	1/8	.984	.010	.139	24,99	0,25	3,53
-215	1- 1/16	1- 5/16	1/8	1.046	.010	.139	26,57	0,25	3,53
-216	1- 1/8	1- 3/8	1/8	1.109	.012	.139	28,17	0,30	3,53
-217	1- 3/16	1- 7/16	1/8	1.171	.012	.139	29,74	0,30	3,53
-218	1- 1/4	1- 1/2	1/8	1.234	.012	.139	31,34	0,30	3,53
-219	1- 5/16	1- 9/16	1/8	1.296	.012	.139	32,92	0,30	3,53
-220	1- 3/8	1- 5/8	1/8	1.359	.012	.139	34,52	0,30	3,53
-221	1- 7/16	1- 11/16	1/8	1.421	.012	.139	36,09	0,30	3,53
-222	1- 1/2	1- 3/4	1/8	1.484	.015	.139	37,69	0,38	3,53
-223	1- 5/8	1- 7/8	1/8	1.609	.015	.139	40,87	0,38	3,53
-224	1- 3/4	2	1/8	1.734	.015	.139	44,04	0,38	3,53
-225	1- 7/8	2- 1/8	1/8	1.859	.015	.139	47,22	0,46	3,53
-226	2	2- 1/4	1/8	1.984	.018	.139	50,39	0,46	3,53
-227	2- 1/16	2- 3/8	1/8	2.109	.018	.139	53,57	0,46	3,53
-228	2- 1/4	2- 1/2	1/8	2.234	.020	.139	56,74	0,51	3,53
-229	2- 3/8	2- 5/8	1/8	2.359	.020	.139	59,92	0,51	3,53
-230	2- 1/2	2- 3/4	1/8	2.484	.020	.139	63,09	0,51	3,53
-231	2- 5/8	2- 7/8	1/8	2.609	.020	.139	66,27	0,51	3,53
-232	2- 3/4	3	1/8	2.734	.024	.139	69,44	0,61	3,53
-233	2- 7/8	3- 1/8	1/8	2.859	.024	.139	72,62	0,61	3,53
-234	3	3- 1/4	1/8	2.984	.024	.139	75,79	0,61	3,53
-235	3- 1/8	3- 3/8	1/8	3.109	.024	.139	78,97	0,61	3,53
-236	3- 1/4	3- 1/2	1/8	3.234	.024	.139	82,14	0,61	3,53
-237	3- 3/8	3- 5/8	1/8	3.359	.024	.139	85,32	0,61	3,53
-238	3- 1/2	3- 3/4	1/8	3.484	.024	.139	88,49	0,61	3,53
-239	3- 5/8	3- 7/8	1/8	3.609	.024	.139	91,67	0,71	3,53
-240	3- 3/4	4	1/8	3.734	.028	.139	94,84	0,71	3,53
-241	3- 7/8	4- 1/8	1/8	3.859	.028	.139	98,02	0,71	3,53
-242	4	4- 1/4	1/8	3.984	.028	.139	101,19	0,71	3,53

14. A. Standard O-ring Sizes

**Standard O-ring Sizes (200 Series 201 to 285 cross section Diameters w = 139 ± .004 inches, w = 3,53 ± 0,10 mm)**

Size Only	Nominal Size (Inches)			Standard O-ring Size (Inches)			Metric O-ring Size (millimeters)		
				Actual	Per AS 568 A				
AS 568A Uniform									
Dash No.	I.D.	O.D.	W.	I.D.	Tol. +/-	W	I.D.	Tol. +/-	W
-243	4- 1/8	4- 3/8	1/8	4.109	.028	.139	104,37	0,71	3,53
-244	4- 1/4	4- 1/2	1/8	4.234	.030	.139	107,54	0,76	3,53
-245	4- 3/8	4- 5/8	1/8	4.359	.030	.139	110,72	0,76	3,53
-246	4- 1/2	4- 3/4	1/8	4.484	.030	.139	113,89	0,76	3,53
-247	4- 5/8	4- 7/8	1/8	4.609	.030	.139	117,07	0,76	3,53
-248	4- 3/4	5	1/8	4.734	.030	.139	120,24	0,76	3,53
-249	4- 7/8	5- 1/8	1/8	4.859	.035	.139	123,42	0,89	3,53
-250	5	5- 1/4	1/8	4.984	.035	.139	126,59	0,89	3,53
-251	5- 1/8	5- 3/8	1/8	5.109	.035	.139	129,77	0,89	3,53
-252	5- 1/4	5- 1/2	1/8	5.234	.035	.139	132,94	0,89	3,53
-253	5- 3/8	5- 5/8	1/8	5.359	.035	.139	136,12	0,89	3,53
-254	5- 1/2	5- 3/4	1/8	5.484	.035	.139	139,29	0,89	3,53
-255	5- 5/8	5- 7/8	1/8	5.609	.035	.139	142,47	0,89	3,53
-256	5- 3/4	6	1/8	5.734	.035	.139	145,64	0,89	3,53
-257	5- 7/8	6- 1/8	1/8	5.859	.035	.139	148,82	0,89	3,53
-258	6	6- 1/4	1/8	5.984	.035	.139	151,99	0,89	3,53
-259	6- 1/4	6- 1/2	1/8	6.234	.040	.139	158,34	1,02	3,53
-260	6- 1/2	6- 3/4	1/8	6.484	.040	.139	164,69	1,02	3,53
-261	6- 3/4	7	1/8	6.734	.040	.139	171,04	1,02	3,53
-262	7	7- 1/4	1/8	6.984	.040	.139	177,39	1,02	3,53
-263	7- 1/4	7- 1/2	1/8	7.234	.045	.139	183,74	1,14	3,53
-264	7- 1/2	7- 3/4	1/8	7.484	.045	.139	190,09	1,14	3,53
-265	7- 3/4	8	1/8	7.734	.045	.139	196,44	1,14	3,53
-266	8	8- 1/4	1/8	7.984	.045	.139	202,79	1,14	3,53
-267	8- 1/4	8- 1/2	1/8	8.234	.050	.139	209,14	1,27	3,53
-268	8- 1/2	8- 3/4	1/8	8.484	.050	.139	215,49	1,27	3,53
-269	8- 3/4	9	1/8	8.734	.050	.139	221,84	1,27	3,53
-270	9	9- 1/4	1/8	8.984	.050	.139	228,19	1,27	3,53
-271	9- 1/4	9- 1/2	1/8	9.234	.055	.139	234,54	1,40	3,53
-272	9- 1/2	9- 3/4	1/8	9.484	.055	.139	240,89	1,40	3,53
-273	9- 3/4	10	1/8	9.734	.055	.139	247,24	1,40	3,53
-274	10	10- 1/4	1/8	9.984	.055	.139	253,59	1,40	3,53
-275	10- 1/2	10- 3/4	1/8	10.484	.055	.139	266,29	1,40	3,53
-276	11	11- 1/4	1/8	10.984	.065	.139	278,99	1,65	3,53
-277	11- 1/2	11- 3/4	1/8	11.484	.065	.139	291,69	1,65	3,53
-278	12	12- 1/4	1/8	11.984	.065	.139	304,39	1,65	3,53
-279	13	13- 1/4	1/8	12.984	.065	.139	329,79	1,65	3,53
-280	14	14- 1/4	1/8	13.984	.065	.139	355,19	1,65	3,53
-281	15	15- 1/4	1/8	14.984	.065	.139	380,59	1,65	3,53
-282	16	16- 1/4	1/8	15.955	.075	.139	405,26	1,91	3,53
-283	17	17- 1/4	1/8	16.955	.080	.139	430,66	2,03	3,53
-284	18	18- 1/4	1/8	17.955	.085	.139	456,06	2,16	3,53

14. A. Standard O-ring Sizes

Standard O-ring Sizes (300 Series 309 to 395 cross section Diameters  $w = .210 \pm .005$  inches,  $w = 5,33 \pm 0,13$  mm)

Size Only	Nominal Size (Inches)			Standard O-ring Size (Inches)			Metric O-ring Size (millimeters)		
				Actual	Per AS 568 A		Actual	Per AS 568A	
AS 568A Uniform									
Dash No.	I.D.	O.D.	W.	I.D.	Tol. +/-	W	I.D.	Tol. +/-	W
-309	7/16	13/16	3/16	.412	.005	.210	10,46	0,13	5,33
-310	1/2	7/8	3/16	.475	.005	.210	12,07	0,13	5,33
-311	9/16	15/16	3/16	.537	.007	.210	13,64	0,18	5,33
-312	5/8	1	3/16	.600	.009	.210	15,24	0,23	5,33
-313	11/16	1- 1/16	3/16	.662	.009	.210	16,81	0,23	5,33
-314	3/4	1- 1/8	3/16	.725	.010	.210	18,42	0,25	5,33
-315	13/16	1- 3/16	3/16	.787	.010	.210	19,99	0,25	5,33
-316	7/8	1- 1/4	3/16	.850	.010	.210	21,59	0,25	5,33
-317	15/16	1- 5/16	3/16	.912	.010	.210	23,16	0,25	5,33
-318	1	1- 3/8	3/16	.975	.010	.210	24,77	0,25	5,33
-319	1- 1/16	1- 7/16	3/16	1.037	.010	.210	26,34	0,25	5,33
-320	1- 1/8	1- 1/2	3/16	1.100	.012	.210	27,94	0,30	5,33
-321	1- 3/16	1- 9/16	3/16	1.162	.012	.210	29,51	0,30	5,33
-322	1- 1/4	1- 5/8	3/16	1.225	.012	.210	31,12	0,30	5,33
-323	1- 5/16	1- 11/16	3/16	1.287	.012	.210	32,69	0,30	5,33
-324	1- 3/8	1- 3/4	3/16	1.350	.012	.210	34,29	0,30	5,33
-325	1- 1/2	1- 7/8	3/16	1.475	.015	.210	37,47	0,38	5,33
-326	1- 5/8	2	3/16	1.600	.015	.210	40,64	0,38	5,33
-327	1- 3/4	2- 1/8	3/16	1.725	.015	.210	43,82	0,38	5,33
-328	1- 7/8	2- 1/4	3/16	1.850	.015	.210	46,99	0,38	5,33
-329	2	2- 3/8	3/16	1.975	.018	.210	50,17	0,46	5,33
-330	2- 1/8	2- 1/2	3/16	2.100	.018	.210	53,34	0,46	5,33
-331	2- 1/4	2- 5/8	3/16	2.225	.018	.210	56,52	0,46	5,33
-332	2- 3/8	2- 3/4	3/16	2.350	.018	.210	59,69	0,46	5,33
-333	2- 1/2	2- 7/8	3/16	2.475	.020	.210	62,87	0,51	5,33
-334	2- 5/8	3	3/16	2.600	.020	.210	66,04	0,51	5,33
-335	2- 3/4	3- 1/8	3/16	2.725	.020	.210	69,22	0,51	5,33
-336	2- 7/8	3- 1/4	3/16	2.850	.020	.210	72,39	0,51	5,33
-337	3	3- 3/8	3/16	2.975	.024	.210	75,37	0,61	5,33
-338	3- 1/8	3- 1/2	3/16	3.100	.024	.210	78,74	0,61	5,33
-339	3- 1/4	3- 5/8	3/16	3.225	.024	.210	81,92	0,61	5,33
-340	3- 3/8	3- 3/4	3/16	3.350	.024	.210	85,09	0,61	5,33
-341	3- 1/2	3- 7/8	3/16	3.475	.024	.210	88,27	0,61	5,33
-342	3- 5/8	4	3/16	3.600	.028	.210	91,44	0,71	5,33
-343	3- 3/4	4- 1/8	3/16	3.725	.028	.210	94,62	0,71	5,33
-344	3- 7/8	4- 1/4	3/16	3.850	.028	.210	97,79	0,71	5,33
-345	4	4- 3/8	3/16	3.975	.028	.210	100,97	0,71	5,33
-346	4- 1/8	4- 1/2	3/16	4.100	.028	.210	104,14	0,71	5,33
-347	4- 1/4	4- 5/8	3/16	4.225	.030	.210	107,32	0,76	5,33
-348	4- 3/8	4- 3/4	3/16	4.350	.030	.210	110,49	0,76	5,33
-349	4- 1/2	4- 7/8	3/16	4.475	.030	.210	113,67	0,76	5,33
-350	4- 5/8	5	3/16	4.600	.030	.210	116,84	0,76	5,33
-351	4- 3/4	5- 1/8	3/16	4.725	.030	.210	120,02	0,76	5,33
-352	4- 7/8	5- 1/4	3/16	4.850	.030	.210	123,19	0,76	5,33

14. A. Standard O-ring Sizes

Standard O-ring Sizes (300 Series 309 to 395 cross section Diameters  $w = .210 \pm .005$  inches,  $w = 5,33 \pm 0,13$  mm)

Size Only	Nominal Size (Inches)			Standard O-ring Size (Inches)			Metric O-ring Size (millimeters)		
				Actual	Per AS 568 A		Actual	Per AS 568A	
AS 568A Uniform									
Dash No.	I.D.	O.D.	W.	I.D.	+/-	W	I.D.	+/-	W
-353	5	5- 3/8	3/16	4.975	.037	.210	126,37	0,94	5,33
-354	5- 1/8	5- 1/2	3/16	5.100	.037	.210	129,54	0,94	5,33
-355	5- 1/4	5- 3/8	3/16	5.225	.037	.210	132,72	0,94	5,33
-356	5- 3/8	5- 3/4	3/16	5.350	.037	.210	135,89	0,94	5,33
-357	5- 1/2	5- 7/8	3/16	5.475	.037	.210	139,07	0,94	5,33
-358	5- 5/8	6	3/16	5.600	.037	.210	142,24	0,94	5,33
-359	5- 3/4	6- 1/8	3/16	5.725	.037	.210	145,42	0,94	5,33
-360	5- 7/8	6- 1/4	3/16	5.850	.037	.210	148,59	0,94	5,33
-361	6	6- 3/8	3/16	5.975	.037	.210	151,77	0,94	5,33
-362	6- 1/4	6- 5/8	3/16	6.225	.040	.210	158,12	1,02	5,33
-363	6- 1/2	6- 7/8	3/16	6.475	.040	.210	164,47	1,02	5,33
-364	6- 3/4	7- 1/8	3/16	6.725	.040	.210	170,82	1,02	5,33
-365	7	7- 3/8	3/16	6.975	.040	.210	177,17	1,02	5,33
-366	7- 1/4	7- 5/8	3/16	7.225	.045	.210	183,52	1,14	5,33
-367	7- 1/2	7- 7/8	3/16	7.475	.045	.210	189,87	1,14	5,33
-368	7- 3/4	8- 1/8	3/16	7.725	.045	.210	196,22	1,14	5,33
-369	8	8- 3/8	3/16	7.925	.045	.210	202,57	1,14	5,33
-370	8- 1/4	8- 5/8	3/16	8.225	.050	.210	208,92	1,27	5,33
-371	8- 1/2	8- 7/8	3/16	8.475	.050	.210	215,27	1,27	5,33
-372	8- 3/4	9- 1/8	3/16	8.725	.050	.210	221,62	1,27	5,33
-373	9	9- 3/8	3/16	8.975	.050	.210	227,97	1,27	5,33
-374	9- 1/4	9- 5/8	3/16	9.225	.055	.210	234,32	1,40	5,33
-375	9- 1/2	9- 7/8	3/16	9.475	.055	.210	240,67	1,40	5,33
-376	9- 3/4	10- 1/8	3/16	9.725	.055	.210	247,02	1,40	5,33
-377	10	10- 3/8	3/16	9.975	.055	.210	253,37	1,40	5,33
-378	10- 1/2	10- 7/8	3/16	10.475	.060	.210	266,07	1,52	5,33
-379	11	11- 3/8	3/16	10.975	.060	.210	278,77	1,52	5,33
-380	11- 1/2	11- 7/8	3/16	11.475	.065	.210	291,47	1,65	5,33
-381	12	12- 3/8	3/16	11.975	.065	.210	304,17	1,65	5,33
-382	13	13- 3/8	3/16	12.975	.065	.210	329,57	1,65	5,33
-383	14	14- 3/8	3/16	13.975	.070	.210	354,97	1,78	5,33
-384	15	15- 3/8	3/16	14.975	.070	.210	380,37	1,78	5,33
-385	16	16- 3/8	3/16	15.955	.075	.210	405,26	1,91	5,33
-386	17	17- 3/8	3/16	16.955	.080	.210	430,66	2,03	5,33
-387	18	18- 3/8	3/16	17.955	.085	.210	456,06	2,16	5,33
-388	19	19- 3/8	3/16	18.955	.090	.210	481,41	2,29	5,33
-389	20	20- 3/8	3/16	19.955	.095	.210	506,81	2,41	5,33
-390	21	21- 3/8	3/16	20.955	.095	.210	532,21	2,41	5,33
-391	22	22- 3/8	3/16	21.955	.100	.210	557,61	2,54	5,33
-392	23	23- 3/8	3/16	22.940	.105	.210	582,68	2,67	5,33
-393	24	24- 3/8	3/16	23.940	.110	.210	608,08	2,79	5,33
-394	25	25- 3/8	3/16	24.940	.115	.210	633,48	2,92	5,33
-395	26	26- 3/8	3/16	25.940	.120	.210	658,88	3,05	5,33



### 14. A. Standard O-ring Sizes

**Standard O-ring Sizes (400 Series 425 to 475 cross section Diameters  $w = .275 \pm .006$  inches,  $w = 6,99 \pm 0,15$  mm)**

Size Only	Nominal Size (Inches)			Standard O-ring Size (Inches)			Metric O-ring Size (millimeters)			
				Actual	Per AS 568 A					
AS 568A Uniform							Actual	Per AS 568A		
Dash No.	I.D.	O.D.	W.	I.D.	Tol. +/-	W	I.D.	Tol. +/-	W	
-425	4- 1/2	5	1/4	4.475	.033	.275	113,67	0,84	6,99	
-426	4- 5/8	5- 1/8	1/4	4.600	.033	.275	116,84	0,84	6,99	
-427	4- 3/4	5- 1/4	1/4	4.725	.033	.275	120,02	0,84	6,99	
-428	4- 7/8	5- 3/8	1/4	4.850	.033	.275	123,19	0,84	6,99	
-429	5	5- 1/2	1/4	4.975	.037	.275	126,37	0,94	6,99	
-430	5- 1/8	5- 5/8	1/4	5.100	.037	.275	129,54	0,94	6,99	
-431	5- 1/4	5- 3/4	1/4	5.225	.037	.275	132,72	0,94	6,99	
-432	5- 3/8	5- 7/8	1/4	5.350	.037	.275	135,89	0,94	6,99	
-433	5- 1/2	6	1/4	5.475	.037	.275	139,07	0,94	6,99	
-434	5- 5/8	6- 1/8	1/4	5.600	.037	.275	142,24	0,94	6,99	
-435	5- 3/4	6- 1/4	1/4	5.725	.037	.275	145,42	0,94	6,99	
-436	5- 7/8	6- 3/8	1/4	5.850	.037	.275	148,59	0,94	6,99	
-437	6	6- 1/2	1/4	5.975	.037	.275	151,77	0,94	6,99	
-438	6- 1/4	6- 3/4	1/4	6.225	.040	.275	158,12	1,02	6,99	
-439	6- 1/2	7	1/4	6.475	.040	.275	164,47	1,02	6,99	
-440	6- 3/4	7- 1/4	1/4	6.725	.040	.275	170,82	1,02	6,99	
-441	7	7- 1/2	1/4	6.975	.040	.275	177,17	1,02	6,99	
-442	7- 1/4	7- 3/4	1/4	7.225	.045	.275	183,52	1,14	6,99	
-443	7- 1/2	8	1/4	7.475	.045	.275	189,87	1,14	6,99	
-444	7- 3/4	8- 1/4	1/4	7.725	.045	.275	196,22	1,14	6,99	
-445	8	8- 1/2	1/4	7.975	.045	.275	202,57	1,14	6,99	
-446	8- 1/2	9	1/4	8.475	.055	.275	215,27	1,40	6,99	
-447	9	9- 1/2	1/4	8.975	.055	.275	227,97	1,40	6,99	
-448	9- 1/2	10	1/4	9.475	.055	.275	240,67	1,40	6,99	
-449	10	10- 1/2	1/4	9.975	.055	.275	253,37	1,40	6,99	
-450	10- 1/2	11	1/4	10.475	.060	.275	266,07	1,52	6,99	
-451	11	11- 1/2	1/4	10.975	.060	.275	278,77	1,52	6,99	
-452	11- 1/2	12	1/4	11.475	.060	.275	291,47	1,52	6,99	
-453	12	12- 1/2	1/4	11.975	.060	.275	304,17	1,52	6,99	
-454	12- 1/2	13	1/4	12.475	.060	.275	316,87	1,52	6,99	
-455	13	13- 1/2	1/4	12.975	.060	.275	329,57	1,52	6,99	
-456	13- 1/2	14	1/4	13.475	.070	.275	342,27	1,78	6,99	
-457	14	14- 1/2	1/4	13.975	.070	.275	354,97	1,78	6,99	
-458	14- 1/2	15	1/4	14.475	.070	.275	367,67	1,78	6,99	
-459	15	15- 1/2	1/4	14.975	.070	.275	380,37	1,78	6,99	
-460	15- 1/2	16	1/4	15.475	.070	.275	393,07	1,78	6,99	
-461	16	16- 1/2	1/4	15.955	.075	.275	405,26	1,91	6,99	
-462	16- 1/2	17	1/4	16.455	.075	.275	417,96	1,91	6,99	
-463	17	17- 1/2	1/4	16.955	.080	.275	430,66	2,03	6,99	
-464	17- 1/2	18	1/4	17.455	.085	.275	443,36	2,16	6,99	
-465	18	18- 1/2	1/4	17.955	.085	.275	456,06	2,16	6,99	
-466	18- 1/2	19	1/4	18.455	.085	.275	468,76	2,16	6,99	
-467	19	19- 1/2	1/4	18.955	.090	.275	481,46	2,29	6,99	
-468	19- 1/2	20	1/4	19.455	.090	.275	494,16	2,29	6,99	
-469	20	20- 1/2	1/4	19.955	.095	.275	506,86	2,41	6,99	
-470	21	21- 1/2	1/4	20.955	.095	.275	532,26	2,41	6,99	
-471	22	22- 1/2	1/4	21.955	.100	.275	557,66	2,54	6,99	
-472	23	23- 1/2	1/4	22.940	.105	.275	582,68	2,67	6,99	
-473	24	24- 1/2	1/4	23.940	.110	.275	608,08	2,79	6,99	
-474	25	25- 1/2	1/4	24.940	.115	.275	633,48	2,92	6,99	
-475	26	26- 1/2	1/4	25.940	.120	.275	658,88	3,05	6,99	

### 14. A. Standard O-ring Sizes

Standard O-ring Sizes (900 series)

AS 568A Uniform Dash No.	Tube O.D. (Ref)	O-ring Size - Actual (b) per AS568A (Units are in inches)				Metric O-ring Size per AS568A (b) (Units are in millimeters)			
		Tolerance (C)				Tolerance (C)			
		I.D.	±	W	±	I.D.	±	W	±
-901	3/32	.185	.005	.056	.003	4,70	0,13	1,42	0,08
-902	1/8	.239	.005	.064	.003	6,07	0,13	1,63	0,08
-903	3/16	.301	.005	.064	.003	7,65	0,13	1,63	0,08
-904	1/4	.351	.005	.072	.003	8,92	0,13	1,83	0,08
-905	5/16	.414	.005	.072	.003	10,52	0,13	1,83	0,08
-906	3/8	.468	.005	.078	.003	11,89	0,13	1,98	0,08
-907	7/16	.530	.007	.082	.003	13,46	0,18	2,08	0,08
-908	1/2	.644	.009	.087	.003	16,36	0,23	2,21	0,08
-909	9/16	.706	.009	.097	.003	17,93	0,23	2,46	0,08
-910	5/8	.755	.009	.097	.003	19,18	0,23	2,46	0,08
-911	11/16	.863	.009	.116	.004	21,92	0,23	2,95	0,10
-912	3/4	.924	.009	.116	.004	23,47	0,23	2,95	0,10
-913	13/16	.986	.010	.116	.004	25,04	0,26	2,95	0,10
-914	7/8	1.047	.010	.116	.004	26,59	0,26	2,95	0,10
-916	1	1.171	.010	.116	.004	29,74	0,26	2,95	0,10
-918	1- 1/8	1.355	.012	.116	.004	34,42	0,30	2,95	0,10
-920	1- 1/4	1.475	.014	.118	.004	37,47	0,36	3,00	0,10
-924	1- 1/2	1.720	.014	.118	.004	43,69	0,36	3,00	0,10
-928	1- 3/4	2.090	.018	.118	.004	53,09	0,46	3,00	0,10
-932	2	2.337	.018	.118	.004	59,36	0,46	3,00	0,10

These O-rings are intended for use with internal straight thread fluid connection bosses and tube fittings.

Ref. AND10049, AND10050, MS33656, MS33657, SAE straight thread O-ring boss and mating swivel and adjustable style fittings.

### 14. B. Metric O-ring Sizes

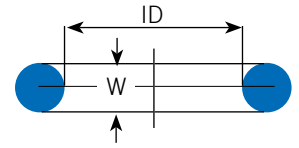

Norm	I.D. (mm)	W (mm)
001	0,74	1,02
	1	1
002	1,07	1,27
R000	1,15	1
	1,2	0,7
	1,25	1
102	1,25	2,62
	1,3	0,7
	1,4	0,7
003	1,42	1,52
	1,5	1
003,5	1,78	1,02
004	1,78	1,78
	1,8	0,7
	1,8	1
	1,8	1,2
	1,8	1,5
	2	1
	2	1,3
	2	1,5
	2	2
103	2,06	2,62
R00	2,2	1,6
	2,3	0,9
R 0	2,4	1,9
	2,5	1
	2,5	1,2
	2,5	1,3
	2,5	1,5
005	2,57	1,78
	2,6	1,2
R 1	2,6	1,9
	2,6	2,4
	2,7	1
	2,8	1,6
104	2,85	2,62
006	2,9	1,78
	3	1
	3	1,25
	3	1,5
	3	2
	3	2,4
	3	3
	3	3,5
	3,1	1,6
	3,1	2,6
	3,2	1,78
	3,3	2,4
R2	3,4	1,9
	3,5	1
	3,5	1,2

Norm	I.D. (mm)	W (mm)
	3,5	1,5
	3,5	2
	3,6	2,4
105	3,63	2,62
007	3,68	1,78
	3,7	1
	3,7	1,6
	3,7	1,9
	3,8	1,25
	4	1
	4	1,1
	4	1,2
	4	1,5
	4	1,8
	4	1,8
	4	2
	4	2,2
	4	2,5
	4	3
	4,1	1,6
	4,2	1,1
	4,2	1,4
R 3	4,2	1,9
	4,3	2,4
	4,34	3,53
	4,4	1,1
106	4,42	2,62
008	4,47	1,78
	4,5	1
	4,5	1,5
	4,5	1,8
	4,5	2
	4,6	2,4
	4,7	1,42
	4,7	1,6
	4,76	1,78
R 4	4,9	1,9
	5	1
	5	1,2
	5	1,5
	5	1,75
	5	2
	5	2,5
	5	3
	5	3,5
	5	4
	5,1	1,6
107	5,23	2,62
009	5,28	1,78
	5,3	2,4
	5,5	1

Norm	I.D. (mm)	W (mm)
	5,5	1,5
	5,5	1,6
	5,5	2
	5,5	2,4
	5,5	2,5
	5,6	2
	5,6	2,4
R5	5,7	1,9
	5,8	1,9
	5,94	3,53
	6	1
	6	1,2
	6	1,5
	6	1,8
	6	2
R6BIS	6	2,2
	6	2,3
	6	2,5
	6	3
	6	4
	6,02	1,63
108	6,02	2,62
010	6,07	1,78
	6,1	0,84
	6,1	1,6
	6,3	2,4
R 5BIS	6,35	1,78
R5A	6,4	1,9
	6,5	1
	6,5	1,5
	6,5	2
	6,5	3
	6,6	2,4
	6,75	1,78
	6,8	1,9
	6,86	1,78
	7	1
	7	1,2
	7	1,5
	7	1,8
	7	2
	7	2,5
	7	3
	7	4
	7	5
	7,1	1,6
R 6	7,2	1,9
	7,3	2,2
	7,3	2,4
	7,5	1,5
	7,5	2

### 14. B. Metric O-ring Sizes

Norm	I.D. (mm)	W (mm)
	7,5	2,2
	7,5	2,5
	7,5	3,2
203	7,52	3,53
	7,6	1,2
	7,6	2,4
109	7,6	2,62
	7,65	1,63
011	7,65	1,78
	7,8	1,9
	7,93	4,76
	7,94	1,78
	8	1
	8	1,25
	8	1,5
R 6A	8	1,9
	8	2
	8	2,4
	8	2,5
	8	3
	8	3,5
	8	4
	8	5
	8,1	1,6
	8,3	1
	8,3	2,4
	8,5	1
	8,5	1,27
	8,5	1,5
	8,5	2
	8,5	2,5
	8,6	2,4
	8,7	2
	8,73	1,78
R7	8,9	1,9
R8	8,9	2,7
	8,92	1,83
	9	1
	9	1,5
	9	2
R 7BIS	9	2,2
	9	2,5
	9	3
	9	3,5
	9	4
	9	4,5
	9,1	1,6
204	9,12	3,53
110	9,2	2,62
012	9,25	1,78
	9,3	2,4

Norm	I.D. (mm)	W (mm)
	9,5	1
	9,5	1,5
	9,5	1,6
	9,5	2
	9,5	2,5
	9,5	3
R8BIS	9,52	1,78
	9,6	2,4
	9,75	1,78
	9,8	1,9
	9,8	2,4
	9,92	2,62
	10	1
	10	1,3
	10	1,5
	10	2
	10	2,2
	10	2,5
	10	3
	10	3,5
	10	4
	10	5
	10	6,5
	10,1	1,6
	10,3	2,4
309	10,47	5,33
	10,5	1,5
	10,5	2
	10,5	2,5
R9	10,5	2,7
	10,6	2,4
205	10,69	3,53
	10,72	1,83
111	10,77	2,62
013	10,82	1,78
	11	1
	11	1,3
	11	1,5
	11	1,8
	11	2
	11	2,5
	11	3
	11	3,5
	11	4
	11	5
	11	5,5
	11,1	1,6
	11,11	1,78
	11,3	2,4
	11,5	1,5
	11,5	2,5

Norm	I.D. (mm)	W (mm)
	11,5	3
	11,6	1,2
	11,6	2,4
	11,6	6,35
	11,7	5,8
	11,8	2,4
	11,9	1,98
	11,91	1,78
	11,91	2,62
	12	1
	12	1,2
	12	1,5
	12	2
	12	2,25
	12	2,5
	12	3
	12	3,5
	12	4
	12	4,5
	12	5
	12	7
310	12,07	5,33
	12,1	1,6
R10	12,1	2,7
206	12,29	3,53
	12,3	1,9
	12,3	2,4
112	12,37	2,62
014	12,42	1,78
	12,5	1,5
	12,5	2
	12,5	2,5
	12,5	3
	12,5	3
	12,6	2,4
	12,7	2,62
	13	1
	13	1,3
	13	1,5
	13	2
	13	2,5
	13	3
	13	3,5
	13	4
	13	5
	13	6
	13,1	1,6
	13,1	2,62
	13,26	1,52
	13,29	1,78
	13,3	2,4
	13,46	2,08

### 14. B. Metric O-ring Sizes

Norm	I.D. (mm)	W (mm)	Norm	I.D. (mm)	W (mm)	Norm	I.D. (mm)	W (mm)
13,5	1,3			16	1,25		18	3,5
	13,5	2		16	1,5		18	4
	13,5	3		16	1,9		18	4,5
	13,6	2,4		16	2		18	5
R11	13,6	2,7		16	2,5		18	6
311	13,64	5,33		16	3		18,1	1,6
	13,8	2,4		16	3,5		18,2	3
207	13,87	3,53		16	4		18,3	2,4
113	13,95	2,62		16	4,5	R15	18,3	3,6
	14	1		16	5	R14	18,4	2,7
	14	1,25		16	6	314	18,42	5,33
	14	1,5		16,1	1,6		18,5	1,2
015	14	1,78		16,3	2,4		18,5	1,5
	14	2		16,36	2,21		18,5	2
	14	2,5		16,4	1		18,5	2,5
	14	3		16,5	2		18,5	3
	14	3,5		16,5	2,5		18,6	2,4
	14	4		16,6	2,4	210	18,64	3,53
	14	5	313	16,82	5,33	116	18,72	2,62
	14,1	1,6	R13	16,9	2,7	018	18,77	1,78
	14,3	2,4		17	1		19	1
	14,5	2		17	1,2		19	1,5
	14,5	3		17	1,5		19	2
	14,6	2,4		17	2		19	2,5
	14,8	2,4		17	2,5		19	3
	15	1		17	3		19	3,5
	15	1,5		17	3,5		19	4
	15	2		17	4		19	5
	15	2,5		17	5		19,1	1,6
	15	3	209	17,04	3,53		19,15	1,78
	15	3,2		17,1	1,6		19,18	2,46
	15	3,5	115	17,12	2,62		19,2	3
	15	4	017	17,17	1,78		19,3	2,4
	15	5		17,3	2,4		19,5	1
	15,08	2,62		17,4	1,6		19,5	1,5
	15,1	1,6		17,46	2,62		19,5	2
R12	15,1	2,7		17,5	1		19,5	2,4
	15,1	4,35		17,5	1,5		19,5	3
	15,2	1,78		17,5	2		19,8	2,4
312	15,24	5,33		17,5	2,5	R16	19,8	3,6
	15,3	2,4		17,6	2,4	315	19,99	5,33
208	15,47	3,53		17,8	2,4		20	1
	15,5	1,5		17,86	2,62		20	1,3
	15,5	3		17,93	2,46		20	1,5
	15,5	3,2		18	1		20	2
114	15,55	2,62		18	1,5		20	2,5
016	15,6	1,78		18	1,8		20	2,65
	15,6	2,4		18	2		20	3
	15,8	2,4		18	2,2		20	3,5
	15,88	2,62		18	2,5		20	4
	16	1		18	3		20	4,5

### 14. B. Metric O-ring Sizes

Norm	I.D. (mm)	W (mm)	Norm	I.D. (mm)	W (mm)	Norm	I.D. (mm)	W (mm)
	20	5		22,22	2,62	318	24,77	5,33
	20	6		22,3	2,4	214	24,99	3,53
	20	8		22,5	1,5		25	1
	20,1	1,6		22,5	2		25	1,5
211	20,22	3,53		22,5	3		25	2
	20,3	2,4		22,6	1,1		25	2,5
117	20,3	2,62		22,8	0,8		25	3
019	20,35	1,78		23	1		25	3,5
	20,5	2		23	1,2		25	4
	20,5	2,4		23	1,5		25	5
	20,5	2,5		23	2		25	6
	20,63	2,62		23	2,5		25	7
	20,8	2,4		23	3		25	8
	21	1	R18	23	3,6	120	25,07	2,62
	21	1,5		23	4		25,1	1,6
	21	2		23	4,5	022	25,12	1,78
	21	2,5		23	5		25,2	3
	21	3		23	6		25,3	2,4
	21	3,5	317	23,17	5,33		25,5	3
	21	4	213	23,39	3,53		25,8	3,53
	21	4,5	119	23,47	2,62		26	1
	21	5		23,47	2,95		26	1,2
	21	6		23,5	1		26	1,5
	21	6,5		23,5	2		26	2
	21,1	1,6		23,5	2,4		26	2,5
	21,3	2,4	021	23,52	1,78		26	3
	21,3	3,6		23,6	2,4		26	3,5
R17	21,5	1,5		23,7	3,5		26	4
	21,5	2		23,81	2,62		26	4,5
	21,5	2,4		23,81	2,62		26	5
	21,5	3		24	1		26	6
	21,5	4,5		24	1,2		26,07	2,62
316	21,59	5,33		24	1,5		26,2	3
	21,6	2,4		24	2	R20	26,2	3,6
	21,7	3,5		24	2,5	319	26,34	5,33
212	21,82	3,53		24	3		26,5	3
118	21,9	2,62		24	3,5	215	26,57	3,53
	21,92	2,95		24	4		26,61	2,95
020	21,95	1,78		24	5	121	26,65	2,62
	22	1		24	5,5	023	26,7	1,78
	22	1,3		24	6		27	1
	22	1,5		24,2	3		27	1,3
	22	2		24,2	5,7		27	1,5
	22	2,5		24,3	2,4		27	2
	22	3		24,4	3,1		27	2,5
	22	3,5		24,5	2,4		27	3
	22	4		24,5	3		27	3,5
	22	4,5		24,5	4,5		27	4
	22	5		24,6	3		27	5
	22,1	1,6	R19	24,6	3,6		27	6
	22,2	3		24,7	3,5		27,1	1,6

### 14. B. Metric O-ring Sizes

Norm	I.D. (mm)	W (mm)
27,3	2,4	
R20TER	27,3	2,7
	27,5	1,5
	27,5	2
	27,5	2,5
	27,5	3
	27,6	2,4
R21	27,8	3,6
320	27,94	5,33
	28	1
	28	1,2
	28	1,5
	28	2
	28	2,5
	28	3
	28	3,5
	28	4
	28	4,5
	28	5
	28	6
216	28,17	3,53
122	28,25	2,62
024	28,3	1,78
	29	1,5
	29	2
	29	2,5
	29	3
	29	3,5
	29	4
	29	5
	29	8
	29,1	1,6
R20BIS	29,1	2,55
	29,2	3
R22	29,3	3,6
	29,4	1
	29,4	3,1
	29,5	1,5
	29,5	2
	29,5	2,5
	29,5	3
	29,5	4,5
321	29,52	5,33
	29,6	2,4
	29,74	2,95
217	29,74	3,53
123	29,82	2,62
025	29,87	1,78
	29,9	1
	30	1,5
	30	2

Norm	I.D. (mm)	W (mm)
	30	2,5
	30	3
	30	3,5
	30	4
	30	4,5
	30	5
	30	6
	30	7
	30,2	3
	30,3	2,4
	30,5	1
R23	30,8	3,6
	31	1,5
	31	2
	31	2,5
	31	3
	31	3,5
	31	4
	31	4,5
	31	5
322	31,12	5,33
218	31,34	3,53
124	31,42	2,62
026	31,47	1,78
	31,5	2
	31,5	2,5
	31,5	3
	31,6	2,4
	31,7	3,5
	31,8	1
	31,8	1,4
	31,8	1,5
	32	1
	32	1,5
	32	2
	32	2,5
	32	3
	32	3,5
	32	4
	32	4,5
	32	5
	32	5,7
	32	6
	32	7
	32,1	1,6
	32,2	3
	32,5	3
R24	32,5	3,6
323	32,69	5,33
219	32,92	3,53
	33	1,5

Norm	I.D. (mm)	W (mm)
	33	2
	33	2,5
125	33	2,62
	33	3
	33	3,5
	33	4
	33	5
	33	6
027	33,05	1,78
	33,3	2,4
	33,7	3,5
	34	1,5
	34	2
	34	2,5
	34	3
	34	3,5
	34	4
	34	4,5
	34	5
	34	5,5
	34	6
R25	34,1	3,6
	34,2	2
	34,2	3
	34,2	5,7
324	34,29	5,33
	34,4	3,1
	34,5	3
220	34,52	3,53
	34,6	2,4
126	34,6	2,62
028	34,65	1,78
	35	1
	35	1,2
	35	1,5
	35	2
	35	2,5
	35	3
	35	3,5
	35	4
	35	4,5
	35	5
	35	6
	35	10
	35,1	1,6
	35,2	5,7
	35,5	3
R26	35,6	3,6
	35,7	3,5
	36	1,5
	36	1,78

### 14. B. Metric O-ring Sizes

Norm	I.D. (mm)	W (mm)
	36	2
	36	2,5
	36	3,5
	36	4
	36	4,5
	36	5
	36	6
221	36,09	3,53
127	36,17	2,62
	36,2	3
36,5x1	36,5	1
	36,5	2
	36,5	3
	37	1,5
	37	2
	37	2,5
	37	3
	37	3,5
	37	4
	37	4,5
	37	5
	37	6
	37,1	1,6
	37,2	3
	37,2	5,7
R27	37,3	3,6
	37,47	3
325	37,47	5,33
	37,5	3
	37,5	3
	37,5	4,5
	37,6	2,4
222	37,69	3,53
128	37,77	2,62
029	37,82	1,78
	38	1
	38	1,5
	38	2
	38	2,5
	38	3
	38	3,5
	38	4
	38	4,5
	38	5
	38	6
	38	7
	38	10
	39	1
	39	1,5
	39	2
	39	2,5

Norm	I.D. (mm)	W (mm)
	39	3
	39	3,5
	39	4
	39	4,5
	39	5
	39	5,5
	39	6
	39	6,5
	39,2	3
	39,2	5,7
129	39,35	2,62
	39,4	3,1
	39,45	1,78
	39,5	1,5
	39,5	2
	39,5	3
	39,6	2,4
	39,69	3,53
	39,7	3,5
	40	1
	40	1,2
	40	1,5
	40	2
	40	2,5
	40	3
	40	3,5
	40	4
	40	4,5
	40	5
	40	6
	40	7
	40,2	3
326	40,64	5,33
223	40,87	3,53
130	40,95	2,62
	41	1,5
030	41	1,78
	41	2
	41	2,5
	41	3
	41	3,5
	41	4
	41	4,5
	41	5
	41,2	5,7
	41,28	3,53
	41,5	3
	41,6	2,4
	41,7	3,5
	42	1
	42	1,5

Norm	I.D. (mm)	W (mm)
	42	2
	42	2,5
	42	3
	42	3,5
	42	4
	42	4,5
	42	5
	42	5,5
	42	6
	42	7
	42	8
	42	10
	42,1	1,15
	42,2	3
	42,5	3
	42,5	5,33
131	42,52	2,62
	42,86	3,53
	43	1,5
	43	2
	43	2,5
	43	3
	43	3,5
	43	4
	43	4,5
	43	5
	43	6
	43,4	3,6
	43,69	3
327	43,82	5,33
	44	1,5
	44	2
	44	2,5
	44	3
	44	3,5
	44	4
	44	4,5
	44	5
	44	6
224	44,04	3,53
132	44,12	2,62
031	44,17	1,78
	44,2	3
	44,2	5,7
	44,4	3,1
	44,45	3,53
	44,5	3
	44,6	2,4
	45	1,5
	45	2
	45	2,5



### 14. B. Metric O-ring Sizes

Norm	I.D. (mm)	W (mm)
	45	3
	45	3,5
	45	4
	45	4,5
	45	5
	45	5,5
	45	6
	45	7
	45,3	5,7
	45,5	1,5
133	45,7	2,62
	45,84	1,78
	46	1,5
	46	2
	46	2,5
	46	3
	46	4
	46	4,5
	46	5
	46	6
	46,04	3,53
328	46,99	5,33
	47	1,5
	47	2
	47	2,5
	47	3
	47	3,5
	47	4
	47	4,5
	47	5
	47	6
	47	7
	47,2	5,7
225	47,22	3,53
134	47,3	2,62
032	47,35	1,78
	47,6	2,4
	47,63	3,53
	48	1,5
	48	2
	48	2,5
	48	3
	48	3,5
	48	4
	48	4,5
	48	5
	48	6
	48	6,5
	48	7
	48	8
135	48,9	2,62

Norm	I.D. (mm)	W (mm)
	49	1
	49	1,5
	49	2
	49	2,5
	49	3
	49	3,5
	49	4
	49	4,5
	49	5
	49	6
	49	6,5
	49,2	5,7
	49,21	3,53
	49,4	3,1
	49,5	3
	49,6	2,4
	50	1,5
	50	2
	50	2,5
	50	3
	50	3,5
	50	4
	50	4,5
	50	5
	50	5,5
	50	6
	50	6,5
	50	7
	50	16
329	50,17	5,33
226	50,39	3,53
136	50,47	2,62
033	50,52	1,78
	51	2
	51	2,5
	51	3
	51	3,5
	51	4
	51	4,5
	51	5
	51,1	1,6
	51,2	5,7
	51,6	2,4
	52	1,5
	52	2
	52	2,5
	52	3
	52	3,5
	52	4
	52	5
	52	6

Norm	I.D. (mm)	W (mm)
	52	8
137	52,07	2,62
	52,39	3,53
	52,5	5,7
	53	1,5
	53	2
	53	2,5
	53	3
	53	3,5
	53	4
	53	4,5
	53	5
	53	5,7
	53	6
330	53,34	5,33
	53,5	1,2
227	53,57	3,53
138	53,64	2,62
034	53,7	1,78
	53,98	3,53
	54	1,5
	54	2
	54	2,5
	54	3
	54	3,5
	54	4
	54	5
	54	5,5
	54	6
	54	7
	54	8
	54,2	3
	54,2	5,7
	54,4	3,1
	54,5	3
	54,6	2,4
	54,6	5,7
	55	1,5
	55	2
	55	2,5
	55	3
	55	3,5
	55	4
	55	5
	55	6
	55	7
	55,2	5,7
139	55,25	2,62
	55,56	3,53
	55,7	3,75
	56	1,5

### 14. B. Metric O-ring Sizes

Norm	I.D. (mm)	W (mm)
	56	2
	56	2,5
	56	3
	56	3,5
	56	4
	56	4,5
	56	5
331	56,52	5,33
228	56,75	3,53
140	56,82	2,62
035	56,87	1,78
	57	1,5
	57	2
	57	2,5
	57	3
	57	3,5
	57	4
	57	4,5
	57	5
	57	6
	57	6,5
	57	7
	57	8
	57	16
	57,15	3,53
	57,2	5,7
	57,6	2,4
	58	1,5
	58	2
	58	2,5
	58	3
	58	3,5
	58	4
	58	5
	58	6
	58	7
141	58,42	2,62
	58,74	3,53
	59	1,5
	59	2
	59	2,5
	59	3
	59	3,5
	59	4
	59	5
	59	10
	59,2	5,7
	59,4	3,1
	59,5	3
	59,6	2,4
332	59,69	5,33

Norm	I.D. (mm)	W (mm)
229	59,92	3,53
142	59,99	2,62
	60	1
	60	1,5
	60	2
	60	2,5
	60	3
	60	3,5
	60	4
	60	4,5
	60	5
	60	6
	60	7
	60	8
036	60,05	1,78
	60,33	3,53
	61	2
	61	2,5
	61	3
	61	3,5
	61	4
	61	4,5
	61	5
	61	6
	61,2	5,7
	61,6	2,4
143	61,6	2,62
	61,91	3,53
	62	1,5
	62	2
	62	2,5
	62	3
	62	3,5
	62	4
	62	5
	62	5,5
	62	6
	62,2	5,7
333	62,87	5,33
	63	1,5
	63	2
	63	2,5
	63	3
	63	3,5
	63	4
	63	4,5
	63	5
	63	6
	63	7
	63	9
230	63,09	3,53

Norm	I.D. (mm)	W (mm)
144	63,17	2,62
037	63,22	1,78
	63,5	3,53
	64	1,5
	64	2
	64	2,5
	64	3
	64	3,5
	64	4
	64	4,5
	64	5
	64	6
	64,2	5,7
	64,4	3,1
	64,5	3
	64,6	2,4
145	64,77	2,62
	65	1,5
	65	2
	65	2,5
	65	3
	65	3,5
	65	4
	65	4,5
	65	5
	65	6
	65,09	3,53
	66	1,5
	66	2
	66	2,5
	66	3
	66	3,5
	66	4
	66	4,5
	66	5
	66	6
334	66,04	5,33
231	66,27	3,53
146	66,34	2,62
038	66,4	1,78
	66,68	3,53
	67	1,5
	67	2
	67	2,5
	67	3
	67	3,5
	67	4
	67	5
	67	6
	67,2	5,7
	67,6	2,4

### 14. B. Metric O-ring Sizes

Norm	I.D. (mm)	W (mm)
147	67,95	2,62
	68	1,5
	68	2
	68	2,5
	68	3
	68	3,5
	68	4
	68	4,5
	68	5
	68	6
	68	7
	68	8
	68,26	3,53
	69	1,5
	69	2
	69	2,5
	69	3
	69	3,5
	69	4
	69	4,5
	69	5
	69	6
	69,2	5,7
335	69,22	5,33
232	69,44	3,53
	69,5	3
148	69,52	2,62
039	69,57	1,78
	69,6	2,4
	69,85	3,53
	70	1,5
	70	2
	70	2,5
	70	3
	70	3,5
	70	4
	70	4,5
	70	5
	70	5,5
	70	6
	70	6,5
	70	7
	70	8
	70	10
	71	2
	71	2,5
	71	3
	71	3,5
	71	4
	71	4,5
	71	5

Norm	I.D. (mm)	W (mm)
149	71,12	2,62
	71,2	5,7
	71,44	3,53
	72	1,5
	72	2
	72	2,5
	72	3
	72	3,5
	72	4
	72	5
	72	5,5
	72	6
	72	10
	72,2	5,7
336	72,39	5,33
233	72,62	3,53
150	72,7	2,62
040	72,75	1,78
	73	1,5
	73	2
	73	2,5
	73	3
	73	3,5
	73	4
	73	4,5
	73	5
	73	6
	73,03	3,53
	74	1,5
	74	2
	74	2,5
	74	3
	74	3,5
	74	4
	74	4,5
	74	5
	74	6
	74	7
	74	8
	74,2	5,7
	74,3	2,62
	74,4	3,1
	74,5	3
	74,6	5,7
	74,61	3,53
	74,63	5,33
	75	1,5
	75	2
	75	2,5
	75	3
	75	3,5

Norm	I.D. (mm)	W (mm)
	75	4
	75	4,5
	75	5
	75	6
	75	7
	75	7,5
	75	9
337	75,57	5,33
234	75,8	3,53
151	75,87	2,62
041	75,92	1,78
	76	1,5
	76	2
	76	2,5
	76	3
	76	3,5
	76	4
	76	4,5
	76	5
	76	6
	77	1,5
	77	2
	77	2,5
	77	3
	77	3,5
	77	4
	77	5
	77,2	5,7
	77,5	2,62
	78	1,5
	78	2
	78	2,5
	78	3
	78	3,5
	78	4
	78	5
	78	6
338	78,74	5,33
235	78,97	3,53
	79	1,5
	79	1,78
	79	2
	79	2,5
	79	3
	79	3,5
	79	4
	79	5
	79	6
	79,2	5,7
	79,4	3,1
	79,5	3

### 14. B. Metric O-ring Sizes

Norm	I.D. (mm)	W (mm)
	79,77	5,33
	80	2
	80	2,5
	80	3
	80	3,5
	80	4
	80	4,5
	80	5
	80	6
	80	8
	80	10
	80,6	2,62
	81	2
	81	2,5
	81	3
	81	3,5
	81	4
	81	4,5
	81	5
	81	6
	81,2	5,7
339	81,92	5,33
	82	1,5
	82	2
	82	2,5
	82	3
	82	3,5
	82	4
	82	5
	82	7
	82	8
236	82,14	3,53
	82,2	5,7
152	82,22	2,62
042	82,27	1,78
	83	2
	83	2,5
	83	3
	83	3,5
	83	4
	83	4,5
	83	5
	83	5,5
	83,8	2,62
	84	1,5
	84	2
	84	2,5
	84	3
	84	3,5
	84	4
	84	5

Norm	I.D. (mm)	W (mm)
	84	6
	84	9
	84,2	5,7
	84,4	3,1
	84,5	3
	85	1,5
	85	2
	85	2,5
	85	3
	85	3,5
	85	4
	85	4,5
	85	5
	85	6
	85	7
340	85,09	5,33
237	85,32	3,53
	85,34	1,78
	86	1,6
	86	2
	86	2,5
	86	3
	86	3,5
	86	4
	86	4,5
	86	5
	86	6
	86,5	4
	87	1,5
	87	2
	87	2,5
	87	3
	87	3,5
	87	4
	87	5
	87,2	5,7
	87,45	6,98
	88	1,5
	88	2
	88	2,5
	88	3
	88	3,5
	88	4
	88	4,5
	88	5
	88	6
341	88,27	5,33
	88,3	7
238	88,49	3,53
153	88,57	2,62
043	88,62	1,78

Norm	I.D. (mm)	W (mm)
	89	1,5
	89	2
	89	2,5
	89	3
	89	3,5
	89	4
	89	4,5
	89	5
	89,2	5,7
	89,4	3,1
	89,5	3
	89,69	5,34
	90	2
	90	2,5
	90	3
	90	3,5
	90	4
	90	4,5
	90	5
	90	6
	90	7
	90	8
	90	10
	91	2
	91	2,5
	91	3
	91	3,5
	91	4
	91	5
342	91,44	5,33
239	91,67	3,53
	91,7	1,78
	92	1,5
	92	2
	92	2,5
	92	3
	92	3,5
	92	4
	92	4,5
	92	5
	92	6
	92	10
	92,2	5,7
	92,75	2,62
	93	2
	93	2,5
	93	3
	93	3,5
	93	4
	93	5
	93	6

### 14. B. Metric O-ring Sizes

Norm	I.D. (mm)	W (mm)
	94	2
	94	2,5
	94	3
	94	3,5
	94	4
	94	5
	94	8
	94,1	5,7
	94,4	3,1
	94,5	3
343	94,62	5,33
240	94,84	3,53
154	94,92	2,62
044	94,97	1,78
	95	1,5
	95	2
	95	2,5
	95	3
	95	3,5
	95	4
	95	4,5
	95	5
	95	6
	95	7
	95	8
	96	1,5
	96	2
	96	2,5
	96	3
	96	3,5
	96	4
	96	5
	96	6
	96	8
	96,6	1,6
	97	1,5
	97	2
	97	2,5
	97	3
	97	3,5
	97	4
	97	5
	97,2	5,7
344	97,79	5,33
	98	1,2
	98	1,5
	98	2
	98	2,5
	98	3
	98	3,5
	98	4

Norm	I.D. (mm)	W (mm)
	98	4,5
	98	5
	98	6
241	98,02	3,53
	98,05	1,78
	99	2
	99	2,5
	99	3
	99	3,5
	99	4
	99	5
	99	6
	99,2	5,7
	99,4	3,1
	99,5	3
	99,6	5,7
	100	1,5
	100	2
	100	2,5
	100	3
	100	3,5
	100	4
	100	4,5
	100	5
	100	5,34
	100	6
	100	7
	100	8
	100	10
	100,95	1,6
345	100,97	5,33
	101	2,5
	101	3
	101	4,3
	101	4,5
242	101,2	3,53
155	101,27	2,62
045	101,32	1,78
	101,6	5,7
	102	2
	102	2,5
	102	3
	102	3,5
	102	4
	102	5
	103	2
	103	2,5
	103	3
	103	3,5
	103	4
	103	5

Norm	I.D. (mm)	W (mm)
	103	6
	104	3
	104	4
	104	5
	104	5,7
	104	6
346	104,14	5,33
243	104,37	3,53
	104,4	1,78
	104,4	3,1
	104,5	3
	105	2
	105	2,5
	105	3
	105	3,5
	105	4
	105	4,5
	105	5
	105	6
	105	7
	106	2
	106	2,5
	106	3
	106	3,5
	106	4
	106	6
	106	7
	106,5	2,4
	107	2,5
	107	3
	107	4
	107	5
347	107,32	5,33
244	107,54	3,53
156	107,62	2,62
046	107,67	1,78
	108	3
	108	3,2
	108	3,5
	108	4
	108	5
	108	6
	108	8
	109	2
	109	2,5
	109	3
	109	3,5
	109	4
	109	5
	109	5,5
	109	7

### 14. B. Metric O-ring Sizes

Norm	I.D. (mm)	W (mm)
	109,2	5,7
	109,4	3,1
	109,5	3
	109,5	5,33
	109,5	5,5
	110	2
	110	2,5
	110	3
	110	3,5
	110	4
	110	4,5
	110	5
	110	6
	110	7
	110	11
348	110,49	5,33
245	110,72	3,53
	110,74	1,78
	111	3
	111	5
	111	6
	112	2
	112	2,5
	112	3
	112	4
	112	5
	112	6
	113	2,5
	113	3
	113	3,5
	113	4
	113	5
349	113,67	5,33
425	113,67	7
246	113,89	3,53
157	113,97	2,62
	114	2,5
	114	3
	114	4
	114	5
	114	5,5
	114	6
	114	8
	114	9
047	114,02	1,78
	114,3	5,7
	114,4	3,1
	114,5	3
	114,7	7
	115	1
	115	1,6

Norm	I.D. (mm)	W (mm)
	115	2
	115	2,5
	115	3
	115	4
	115	4,5
	115	5
	115	6
	116	2,5
	116	3
	116	4
350	116,84	5,33
426	116,84	7
	117	2,5
	117	2,7
	117	3
	117	4
	117	5
247	117,07	3,53
	117,1	1,78
	117,5	5,34
	118	3
	118	4
	118	5
	118	6
	119	3
	119	4
	119	5
	119,2	5,7
	119,4	3,1
	119,5	3
	120	2
	120	3
	120	3,5
	120	4
	120	5
	120	6
	120	10
351	120,02	5,33
427	120,02	7
248	120,25	3,53
158	120,32	2,62
048	120,37	1,78
	121	4
	121	5
	121,5	2,2
	122	2,5
	122	3
	122	3,5
	122	4
	122	5
	122	6

Norm	I.D. (mm)	W (mm)
	123	3
	123	4
	123	5
	123	6
	123	6,3
352	123,19	5,33
428	123,19	7
249	123,42	3,53
	123,44	1,78
	124	3
	124	3,25
	124	4
	124	5
	124	6
	124	18
	124,3	5,7
	124,4	3,1
	124,5	3
	125	2,4
	125	2,5
	125	3
	125	3,5
	125	4
	125	5
	125	6
	125	8,3
	125,6	2
	126	3
	126	4
	126	5
	126	6
353	126,37	5,33
429	126,37	7
250	126,6	3,53
159	126,67	2,62
049	126,72	1,78
	127	3
	127	4
	127	5
	128	2
	128	3
	128	4
	128	5
	128	6
	129	2,5
	129	3
	129	4
	129	5
	129,2	5,7
	129,4	1,78
	129,4	3,1

### 14. B. Metric O-ring Sizes

Norm	I.D. (mm)	W (mm)
	129,5	3
354	129,54	5,33
430	129,54	7
251	129,77	3,53
	130	2
	130	2,5
	130	3
	130	4
	130	5
	130	6
	130	8
	130,2	5,34
	130,5	3
	131	2,5
	131	3
	131	4
	131	5
	131,2	5,7
	132	3
	132	4
	132	5
	132	6
	132	8
355	132,72	5,33
431	132,72	7
252	132,95	3,53
	133	3
	133	4
	133	5
160	133,02	2,62
050	133,07	1,78
	134	3
	134	4
	134	5
	134	6
	134,3	5,7
	134,4	3,1
	134,5	3
	134,5	6,99
	135	2,5
	135	3
	135	4
	135	5
	135	6
	135	10
	135,76	1,78
356	135,89	5,33
432	135,89	7
	136	3
	136	4
	136	5

Norm	I.D. (mm)	W (mm)
	136	6
253	136,12	3,53
	137	3
	137	4
	137	5
	138	2,1
	138	3
	138	3,5
	138	4
	138	5
	138	6
	138,94	1,78
	139	3
	139	4
	139	5
357	139,07	5,33
433	139,07	7
254	139,3	3,53
	139,3	5,7
161	139,37	2,62
	139,4	3,1
	139,5	3
	139,7	5,34
	140	2
	140	2,5
	140	3
	140	4
	140	5
	140	6
	140	8
	140	10
	141	3
	141	4
	141	5
	142	3
	142	4
	142	5
	142	6
	142,11	1,78
358	142,24	5,33
434	142,24	7
255	142,47	3,53
	143	3
	143	4
	143	5
	144	3
	144	4
	144	5
	144,1	8,4
	144,3	5,7
	144,4	3,1

Norm	I.D. (mm)	W (mm)
	144,5	3
	144,6	5,7
	145	2
	145	2,5
	145	3,5
	145	4
	145	5
	145	5,5
	145,29	1,78
359	145,42	5,33
435	145,42	7
256	145,64	3,53
162	145,72	2,62
	146	3
	146	4
	146	5
	146	6
	146,04	5,33
	147	3
	147	4
	147	5
	148	3
	148	4
	148	5
	148	6
	148	8
	148,46	1,78
360	148,59	5,33
436	148,59	7
257	148,82	3,53
	149	3
	149	4
	149	5
	149,1	8,4
	149,2	5,33
	149,2	5,7
	149,5	3
	149,6	5,7
	150	2
	150	2,5
	150	3
	150	3,5
	150	4
	150	5
	150	6
	150	8
	151,46	1,78
361	151,77	5,33
437	151,77	7
	152	3
258	152	3,53

### 14. B. Metric O-ring Sizes

Norm	I.D. (mm)	W (mm)
	152	4
	152	5
163	152,07	2,62
	153	4,5
	153	5
	153	6
	154	3
	154	4
	154	5
	154	6
	154,1	8,4
	154,3	5,7
	154,5	3
	154,8	5,7
	155	3
	155	4
	155	5
	155	5,33
	155	6
	155,6	7
	156	3
	156	4
	156	5
	156	6
	157	3
	157	4
	157	4,5
	157	5
	157	6
	158	1,78
	158	3
	158	4
	158	5
	158	6
362	158,12	5,33
438	158,12	7
259	158,34	3,53
164	158,42	2,62
	159,1	8,4
	159,3	5,7
	159,5	3
	159,5	7
	159,8	5,7
	160	2
	160	3
	160	3,5
	160	4
	160	5
	160	6
	160	8
	160	10

Norm	I.D. (mm)	W (mm)
	161,3	5,33
	161,6	2,4
	161,9	7
	162	3
	162	4
	162	5
	162	6
	164,1	8,4
	164,2	5,7
363	164,47	5,33
439	164,47	7
	164,5	3
260	164,7	3,53
165	164,77	2,62
	164,8	5,7
	165	2
	165	3
	165	4
	165	5
	165	6
	165	7
	166,7	7
	167	3
	167,7	5,33
	168	3
	168	4
	168	5
	168	5,7
	168,3	7
	169	4
	169	5
	169,1	8,4
	169,3	5,7
	169,5	3
	169,8	5,7
	170	2
	170	3
	170	4
	170	5
	170	6
364	170,82	5,33
440	170,82	7
261	171,04	3,53
166	171,12	2,62
	172	3
	172	4
	172	5
	172	6
	174	3
	174	3,2
	174	4

Norm	I.D. (mm)	W (mm)
	174	5
	174	6
	174,1	8,4
	174,2	5,7
	174,5	3
	174,6	7
	174,8	5,7
	175	2,5
	175	3
	175	4
	175	5
	175	6
365	177,17	5,33
441	177,17	7
262	177,4	3,53
167	177,47	2,62
	178	3
	178	4
	178	5
	178	6
	178	10
	179	3
	179,1	8,4
	179,3	5,7
	179,5	3
	179,8	5,7
	180	2
	180	3
	180	4
	180	5
	180	6
	180	8
	181	7
	182	3
	182	4
	182	5
	182	6
	183,5	3
366	183,52	5,33
442	183,52	7
263	183,74	3,53
168	183,82	2,62
	184	4
	184	5
	184	6
	184,1	8,4
	184,3	5,7
	184,5	3
	184,8	5,7
	185	3
	185	4



### 14. B. Metric O-ring Sizes

Norm	I.D. (mm)	W (mm)
	185	5
	185	6
	186	3
	186	3
	186	4
	187,3	7
	188	3
	188	4
	188	5
	188	6
	189,1	8,4
	189,2	5,7
	189,5	3
	189,8	5,7
367	189,87	5,33
443	189,87	7
	190	3
	190	4
	190	5
	190	6
264	190,1	3,53
169	190,17	2,62
	192	3
	192	4
	192	5
	192	7
	193,3	4
	194	2
	194	4
	194	6,1
	194,1	8,4
	194,3	5,7
	194,5	3
	195	3,5
	195	4
	195	5
	195	6
	195	6,75
	195	8
	195	10
368	196,22	5,33
444	196,22	7
265	196,44	3,53
170	196,52	2,62
	197	3
	198	4
	198	5
	198	6
	199,1	8,4
	199,2	5,7
	199,5	3

Norm	I.D. (mm)	W (mm)
	199,8	5,7
	200	2
	200	3
	200	4
	200	5
	200	6
	200	7
	200	8
	200	15
	202	5
	202	5,5
	202	6
369	202,57	5,33
445	202,57	7
266	202,8	3,53
171	202,87	2,62
	203	3
	203	4
	203	4
	203	5
	203	6
	204	6
	204,2	5,7
	205	2
	205	3
	205	4
	205	4,5
	205	5
	205	6
	205	9
	205	10
	206	6
	208	3
	208	4
	208	5
	208	6
	208,9	7
370	208,92	5,33
	209,1	8,4
267	209,14	3,53
172	209,22	2,62
	209,3	5,7
	209,5	3
	210	2
	210	3
	210	4
	210	5
	210	6
	210	8
	212	3
	212	4

Norm	I.D. (mm)	W (mm)
	212	5
	212	6
	212	6,3
	212	7
	214,3	5,7
	215	3
	215	4
	215	5
	215	6
371	215,27	5,33
446	215,27	7
268	215,5	3,53
173	215,57	2,62
	216	8
	217	5
	218	3
	218	4
	218	4,5
	218	5
	218	5,8
	218	6
	219,1	8,4
	219,3	5,7
	219,5	3
	219,5	3,2
	220	3
	220	4
	220	5
	220	6
	220	10
	221,6	6,99
372	221,62	5,33
269	221,84	3,53
174	221,92	2,62
	222	6
	224	3,8
	225	3
	225	4
	225	5
	225	10
	226	8
	227	3,2
373	227,97	5,33
447	227,97	7
	228	3
	228	4
	228	5
	228	10
270	228,2	3,53
175	228,27	2,62
	229	6

### 14. B. Metric O-ring Sizes

Norm	I.D. (mm)	W (mm)
	229,1	8,4
	229,3	5,7
	229,5	3
	230	3
	230	4
	230	5
	230	6
	230	8
	232	3
	233	3
	234,3	5,7
	234,3	6,99
374	234,32	5,33
271	234,55	3,53
176	234,62	2,62
	235	3
	235	4
	235	5
	235	6
	235	8
	236	12
	238	5
	238	6
	239,1	8,4
	239,3	5,7
	239,5	3
	240	3
	240	4
	240	5
	240	6
	240	8
	240	10
375	240,67	5,33
448	240,67	7
272	240,9	3,53
177	240,97	2,62
	242	8
	245	3
	245	3,5
	245	4
	245	5
	245	8
	246	4
	247	3
	247	5
	247	6
	247	7
376	247,02	5,33
273	247,25	3,53
178	247,32	2,62
	248	5

Norm	I.D. (mm)	W (mm)
	249,1	8,4
	249,3	5,7
	249,5	3
	250	3
	250	4
	250	5
	250	6
	250	6,5
	250	7
	250	8
	250	10
	253	8
377	253,37	5,33
449	253,37	7
274	253,6	3,53
	254	8
	255	3
	255	4
	255	5
	255	5,7
	258	4
	258	6
	259,3	3
	259,3	5,7
	259,7	7
	260	3
	260	4
	260	5
	260	6
	260	8
	262	2
	262	4
	262	5
	264	3
	264	10
	265	4
	265	5
	265	6
	265	8
	265,3	3
378	266,07	5,33
450	266,07	7
275	266,29	3,53
	268	4
	268	5
	268,8	8,4
	269,3	5,7
	270	3
	270	4
	270	5
	270	6

Norm	I.D. (mm)	W (mm)
	270	10
	272,4	6,99
	275	2
	275	3
	275	4
	275	5
	275	6
	278	4
	278	5
	278	6
379	278,77	5,33
451	278,77	7
276	278,99	3,53
	278,99	3,83
	279	8
	279,3	5,7
	280	3
	280	4
	280	5
	280	6
	280	8
	280	10
	283	3,5
	285	3
	285	4
	285	5
	285	6
	285,1	7
	288	4
	288	5
	288	6
	289,3	5,7
	290	2
	290	3
	290	4
	290	5
	290	6
380	291,47	5,33
452	291,47	7
277	291,69	3,53
	292	10
	295	4
	295	5
	295	6
	297	4
	297,8	7
	298	4
	298	5
	299,3	5,7
	300	3
	300	4

### 14. B. Metric O-ring Sizes

Norm	I.D. (mm)	W (mm)
	300	5
	300	6
	300	6,3
	300	7
	300	7
	300	9
	300	10
381	304,17	5,33
453	304,17	7
278	304,39	3,53
	305	4
	305	5
	305	6
	305	10
	308	4
	308	5
	309	3
	309,3	5,7
	310	4
	310	5
	310	6
	310	8
	310	16
	310,5	7
	311	6
	312	4
	312	5
	315	3
	315	4
	315	5
	315	5,33
	315	6
	315	6,3
	315	10
	316	9
454	316,87	7
	318	4
	318	5
	319,2	3,53
	319,3	5,7
	320	3
	320	3,5
	320	4
	320	5
	320	6
	320	6,5
	320	7
	320	8
	320	10
	325	4
	325	5

Norm	I.D. (mm)	W (mm)
	325	6
	325	10
	326	8
	328	10
382	329,57	5,33
455	329,57	7
279	329,79	3,53
	330	3
	330	4
	330	5
	330	5,7
	330	6
	330	6,5
	330	8
	330	10
	335	4
	335	5
	335	6
	339	8,4
	339,3	5,7
	340	4
	340	5
	340	6
	340	10
	340	16
	342	5
456	342,27	7
	344	6,99
	345	4
	345	5
	345	6
	346	10
	347	6
	349,3	5,7
	350	3
	350	4
	350	5
	350	6
	350	8
383	354,97	5,33
457	354,97	7
	355	3
	355	4
	355	5
	355	6
280	355,19	3,53
	357	12
	358	6
	359,3	5,7
	360	4
	360	5

Norm	I.D. (mm)	W (mm)
	360	6
	360	7
	360	7,5
	360	8
	360	9
	360	10
	363	5,33
	365	4
	365	5
	365	6
458	367,67	7
	370	4
	370	5
	370	6
	374	5
	374	8
	375	4
	375	5
	375	6
	375	7
	375	8,4
	378	4
	378	12
	379,3	5,7
	380	4
	380	5
	380	6
	380	8
	380	10
384	380,37	5,33
459	380,37	7
281	380,59	3,53
	385	3
	385	4
	385	5
	385	6
	387	20
	390	3,5
	390	4
	390	5
	390	6
	390	9
	390	16
	391	8
	392	6
460	393,07	7
	394	8,4
	395	4
	395	5
	395	6
	395	8

### 14. B. Metric O-ring Sizes

Norm	I.D. (mm)	W (mm)
	396	12
	399,3	5,7
	400	2
	400	3
	400	4
	400	5
	400	6
	400	7
	400	8
	402	4
	402	9
282	405,26	3,53
385	405,26	5,33
461	405,26	7
	406	3,1
	410	4
	410	5
	410	6
	410	7
	410	8
	410	9
	412	8
	415	5
	415	6
	415	7
462	417,96	7
	419,1	8,4
	419,3	5,7
	420	4
	420	6
	420	8
	420	9
	420	10
	422	6
	422,2	6,2
	422,2	6,9
	425	4
	425	5
	425	6
	425	7
	425	8
	426	5,7
	427	5
	429	6
	430	8,4
283	430,66	3,53
386	430,66	5,33
463	430,66	7
	434	10
	439,3	5,7
	440	3

Norm	I.D. (mm)	W (mm)
	440	4
	440	7
464	443,36	7
	445	5
	445	9
	450	4
	450	6
	450	7
	450	8
	450	10
	451	9
	454	8,4
	455	5
284	456,06	3,53
387	456,06	5,33
465	456,06	7
	459,3	5,7
	460	5
	460	6
	460	7
	460	8
	460	12
	461	8,4
	462	10
	462	15
	465	5
466	468,76	7
	470	4
	470	5
	470	6
	470	8
	470	10
	475	8
	475	10
	478	6
	479,3	5,7
	480	4
	480	5
	480	6
	480	7
	480	8
	480	9
	480	10
388	481,38	5,33
467	481,46	7
	483	8,4
	485	5
	485	5,7
	485	8
	488	6
	489	6

Norm	I.D. (mm)	W (mm)
	490	5
	490	7
	490	8
	490	10
	490	16
	491,49	5,33
	492	4
468	494,16	7
	498	14
	499,3	5,7
	500	3,53
	500	5
	500	6
	500	7
	500	8
	500	9
	500	10
	502	16
	505	3
	505	4
	505	6
	505	10
389	506,78	5,33
469	506,86	7
	510	5
	515	7
	515	8
	517	5,33
	518,5	3
	519,3	5,7
	520	8
	520	10
	520,06	7
	525	5
	525	6
	525	8
	529,3	5,7
	530	4
	530	5
	530	6
	530	7
	530	10
390	532,18	5,33
470	532,26	7
	534	16
	540	10
	541	14
	545	5,7
	545	9
ASA100	545,47	7
	550	5

### 14. B. Metric O-ring Sizes

Norm	I.D. (mm)	W (mm)
	550	6
	550	7
	550	8
	552	4
	552	5,33
	554,3	5,7
391	557,58	5,33
471	557,66	7
	560	8
	560	10
	562	7,5
	566	6,35
	570	10
	573	7
	575	4
	577	20
	577	21
	580	8
	580	9
	580	10
392	582,68	5,33
472	582,68	7
	584	8,4
	585	16
	590	6
	590	10
	594	5,7
	595	6
	595	8
ASA104	596,27	7
	600	7
	600	8
	600	10
393	608,08	5,33
473	608,08	7
	610	6
	610	6,35
	614	7
	617	8
	620	5
	620	8
	620	10
	625	3
	626	7
	630	8
394	633,48	5,33
474	633,48	7
	635	8
	637	10
	638	8
	640	7

Norm	I.D. (mm)	W (mm)
	643	7
	650	7
	650	8
	650	10
395	658,88	5,33
475	658,88	7
	660	9
	660	10
	665	6
	670	7
	670	8
	674	7
	675	8
	680	7
	680	8
	680	8,4
	680	16
	685	7
	690	10
	695	8
	699	7
	700	8
	700	10
	702	20
	705	5,33
	705	7
	710	8,4
	724	7
	725	5,7
	725	9
	730,5	7
	735	7
	736	5,33
	739	7
	740	8,4
	743	10
	745	7
	760	7
	763	10
	770	4
	774,1	8,4
	776	7
	790	6,3
	790	10
	799	12
	800	7
	800	8
	805	20
	805	21
	810	9
	820	7

Norm	I.D. (mm)	W (mm)
	836	3
	845	10
	847	5,33
	850	7
	860	7
	870	5,33
	875	8
	876	7
	878	5,33
	880	7
	890	5,33
	890	5,7
	900	7
	920	7
	925	10
	930	8
	932,5	7
	950	10
	957	7
	975	5,33
	997	7
	1000	10
	1011	7
	1014	5,33
	1029	6,35
	1040	7
	1045	5,33
	1075	7
	1089	6,99
	1100	6,99
	1142	7
	1185	7
	1245	7

**Many more sizes are available upon request in different compounds.**

**Please ask an ERIKS representative for assistance in selecting a custom product.**

14. C. JIS O-ring Sizes \* See page 203 for tolerances

JIS Sizes							
S-3	0,098	0,006	0,059	0,004	2,5	0,15	1,5
S-4	0,138	0,006	0,059	0,004	3,5	0,15	1,5
S-5	0,177	0,006	0,059	0,004	4,5	0,15	1,5
S-6	0,217	0,006	0,059	0,004	5,5	0,15	1,5
S-7	0,256	0,006	0,059	0,004	6,5	0,15	1,5
S-8	0,295	0,006	0,059	0,004	7,5	0,15	1,5
S-9	0,335	0,006	0,059	0,004	8,5	0,15	1,5
S-10	0,374	0,006	0,059	0,004	9,5	0,15	1,5
S-11.2	0,421	0,006	0,059	0,004	10,7	0,15	1,5
S-12	0,453	0,006	0,059	0,004	11,5	0,15	1,5
S-12.5	0,472	0,006	0,059	0,004	12,0	0,15	1,5
S-14	0,531	0,006	0,059	0,004	13,5	0,15	1,5
S-15	0,571	0,006	0,059	0,004	14,5	0,15	1,5
S-16	0,610	0,006	0,059	0,004	15,5	0,15	1,5
S-18	0,689	0,006	0,059	0,004	17,5	0,15	1,5
S-20	0,768	0,006	0,059	0,004	19,5	0,15	1,5
S-22	0,846	0,006	0,059	0,004	21,5	0,15	1,5
S-22.4	0,862	0,006	0,079	0,004	21,9	0,15	2,0
S-24	0,925	0,006	0,079	0,004	23,5	0,15	2,0
S-25	0,965	0,006	0,079	0,004	24,5	0,15	2,0
S-26	1,004	0,006	0,079	0,004	25,5	0,15	2,0
S-28	1,083	0,006	0,079	0,004	27,5	0,15	2,0
S-29	1,122	0,006	0,079	0,004	28,5	0,15	2,0
S-30	1,161	0,006	0,079	0,004	29,5	0,15	2,0
S-31.5	1,220	0,006	0,079	0,004	31,0	0,15	2,0
S-32	1,240	0,006	0,079	0,004	31,5	0,15	2,0
S-34	1,319	0,006	0,079	0,004	33,5	0,15	2,0
S-35	1,358	0,006	0,079	0,004	34,5	0,15	2,0
S-35.5	1,378	0,006	0,079	0,004	35,0	0,15	2,0
S-36	1,398	0,006	0,079	0,004	35,5	0,15	2,0
S-38	1,476	0,006	0,079	0,004	37,5	0,15	2,0
S-39	1,516	0,006	0,079	0,004	38,5	0,15	2,0
S-40	1,555	0,006	0,079	0,004	39,5	0,15	2,0
S-42	1,634	0,010	0,079	0,004	41,5	0,25	2,0
S-44	1,713	0,010	0,079	0,004	43,5	0,25	2,0
S-45	1,752	0,010	0,079	0,004	44,5	0,25	2,0
S-46	1,791	0,010	0,079	0,004	45,5	0,25	2,0
S-48	1,870	0,010	0,079	0,004	47,5	0,25	2,0
S-50	1,949	0,010	0,079	0,004	49,5	0,25	2,0
S-53	2,067	0,010	0,079	0,004	52,5	0,25	2,0
S-55	2,146	0,010	0,079	0,004	54,5	0,25	2,0
S-56	2,185	0,010	0,079	0,004	55,5	0,25	2,0
S-60	2,343	0,010	0,079	0,004	59,5	0,25	2,0
S-63	2,461	0,010	0,079	0,004	62,5	0,25	2,0
S-65	2,539	0,010	0,079	0,004	64,5	0,25	2,0
S-67	2,618	0,010	0,079	0,004	66,5	0,25	2,0
S-70	2,736	0,010	0,079	0,004	69,5	0,25	2,0
S-71	2,776	0,016	0,079	0,004	70,5	0,40	2,0
S-75	2,933	0,016	0,079	0,004	74,5	0,40	2,0
S-80	3,130	0,016	0,079	0,004	79,5	0,40	2,0
S-85	3,327	0,016	0,079	0,004	84,5	0,40	2,0
S-90	3,524	0,016	0,079	0,004	89,5	0,40	2,0

14. C. JIS O-ring Sizes \* See page 203 for tolerances

JIS Sizes							
S-95	3,720	0,016	0,079	0,004	94,5	0,40	2,0
S-100	3,917	0,016	0,079	0,004	99,5	0,40	2,0
S-105	4,114	0,016	0,079	0,004	104,5	0,40	2,0
S-110	4,311	0,016	0,079	0,004	109,5	0,40	2,0
S-112	4,390	0,016	0,079	0,004	111,5	0,40	2,0
S-115	4,508	0,016	0,079	0,004	114,5	0,40	2,0
S-120	4,705	0,016	0,079	0,004	119,5	0,40	2,0
S-125	4,902	0,016	0,079	0,004	124,5	0,40	2,0
S-130	5,098	0,024	0,079	0,004	129,5	0,60	2,0
S-132	5,177	0,024	0,079	0,004	131,5	0,60	2,0
S-135	5,295	0,024	0,079	0,004	134,5	0,60	2,0
S-140	5,492	0,024	0,079	0,004	139,5	0,60	2,0
S-145	5,689	0,024	0,079	0,004	144,5	0,60	2,0
S-150	5,886	0,024	0,079	0,004	149,5	0,60	2,0
P-3	0,110	0,005	0,075	0,003	2,8	0,12	1,9
P-4	0,150	0,005	0,075	0,003	3,8	0,12	1,9
P-5	0,189	0,005	0,075	0,003	4,8	0,12	1,9
P-6	0,228	0,005	0,075	0,003	5,8	0,12	1,9
P-7	0,268	0,005	0,075	0,003	6,8	0,12	1,9
P-8	0,307	0,005	0,075	0,003	7,8	0,12	1,9
P-9	0,346	0,005	0,075	0,003	8,8	0,12	1,9
P-10	0,386	0,005	0,075	0,003	9,8	0,12	1,9
P-10A	0,386	0,005	0,094	0,003	9,8	0,12	2,4
P-11	0,425	0,005	0,094	0,003	10,8	0,12	2,4
P-11.2	0,433	0,005	0,094	0,003	11,0	0,12	2,4
P-12	0,465	0,005	0,094	0,003	11,8	0,12	2,4
P-12.5	0,484	0,005	0,094	0,003	12,3	0,12	2,4
P-14	0,543	0,005	0,094	0,003	13,8	0,12	2,4
P-15	0,583	0,005	0,094	0,003	14,8	0,12	2,4
P-16	0,622	0,005	0,094	0,003	15,8	0,12	2,4
P-18	0,701	0,005	0,094	0,003	17,8	0,12	2,4
P-20	0,780	0,006	0,094	0,003	19,8	0,15	2,4
P-21	0,819	0,006	0,094	0,003	20,8	0,15	2,4
P-22	0,858	0,006	0,094	0,003	21,8	0,15	2,4
P-22A	0,854	0,006	0,138	0,004	21,7	0,15	3,5
P-22.4	0,870	0,006	0,138	0,004	22,1	0,15	3,5
P-24	0,933	0,006	0,138	0,004	23,7	0,15	3,5
P-25	0,972	0,006	0,138	0,004	24,7	0,15	3,5
P-25.5	0,992	0,006	0,138	0,004	25,2	0,15	3,5
P-26	1,012	0,006	0,138	0,004	25,7	0,15	3,5
P-28	1,091	0,006	0,138	0,004	27,7	0,15	3,5
P-29	1,130	0,006	0,138	0,004	28,7	0,15	3,5
P-29.5	1,150	0,006	0,138	0,004	29,2	0,15	3,5
P-30	1,169	0,006	0,138	0,004	29,7	0,15	3,5
P-31	1,209	0,006	0,138	0,004	30,7	0,15	3,5
P-31.5	1,228	0,006	0,138	0,004	31,2	0,15	3,5
P-32	1,248	0,006	0,138	0,004	31,7	0,15	3,5
P-34	1,327	0,006	0,138	0,004	33,7	0,15	3,5
P-35	1,366	0,006	0,138	0,004	34,7	0,15	3,5
P-35.5	1,386	0,006	0,138	0,004	35,2	0,15	3,5
P-36	1,406	0,006	0,138	0,004	35,7	0,15	3,5
P-38	1,484	0,006	0,138	0,004	37,7	0,15	3,5

14. C. JIS O-ring Sizes \* See page 203 for tolerances

JIS Sizes							
P-39	1,524	0,006	0,138	0,004	38,7	0,15	3,5
P-40	1,563	0,006	0,138	0,004	39,7	0,15	3,5
P-41	1,602	0,010	0,138	0,004	40,7	0,25	3,5
P-42	1,642	0,010	0,138	0,004	41,7	0,25	3,5
P-44	1,720	0,010	0,138	0,004	43,7	0,25	3,5
P-45	1,760	0,010	0,138	0,004	44,7	0,25	3,5
P-46	1,799	0,010	0,138	0,004	45,7	0,25	3,5
P-48	1,878	0,010	0,138	0,004	47,7	0,25	3,5
P-49	1,917	0,010	0,138	0,004	48,7	0,25	3,5
P-50	1,957	0,010	0,138	0,004	49,7	0,25	3,5
P-48A	1,874	0,010	0,224	0,006	47,6	0,25	5,7
P-50A	1,953	0,010	0,224	0,006	49,6	0,25	5,7
P-52	2,031	0,010	0,224	0,006	51,6	0,25	5,7
P-53	2,071	0,010	0,224	0,006	52,6	0,25	5,7
P-55	2,150	0,010	0,224	0,006	54,6	0,25	5,7
P-56	2,189	0,010	0,224	0,006	55,6	0,25	5,7
P-58	2,268	0,010	0,224	0,006	57,6	0,25	5,7
P-60	2,346	0,010	0,224	0,006	59,6	0,25	5,7
P-62	2,425	0,010	0,224	0,006	61,6	0,25	5,7
P-63	2,465	0,010	0,224	0,006	62,6	0,25	5,7
P-65	2,543	0,010	0,224	0,006	64,6	0,25	5,7
P-67	2,622	0,010	0,224	0,006	66,6	0,25	5,7
P-70	2,740	0,010	0,224	0,006	69,6	0,25	5,7
P-71	2,780	0,016	0,224	0,006	70,6	0,40	5,7
P-75	2,937	0,016	0,224	0,006	74,6	0,40	5,7
P-80	3,134	0,016	0,224	0,006	79,6	0,40	5,7
P-85	3,331	0,016	0,224	0,006	84,6	0,40	5,7
P-90	3,528	0,016	0,224	0,006	89,6	0,40	5,7
P-95	3,724	0,016	0,224	0,006	94,6	0,40	5,7
P-100	3,921	0,016	0,224	0,006	99,6	0,40	5,7
P-102	4,000	0,016	0,224	0,006	101,6	0,40	5,7
P-105	4,118	0,016	0,224	0,006	104,6	0,40	5,7
P-110	4,315	0,016	0,224	0,006	109,6	0,40	5,7
P-112	4,394	0,016	0,224	0,006	111,6	0,40	5,7
P-115	4,512	0,016	0,224	0,006	114,6	0,40	5,7
P-120	4,709	0,016	0,224	0,006	119,6	0,40	5,7
P-125	4,906	0,016	0,224	0,006	124,6	0,40	5,7
P-130	5,102	0,024	0,224	0,006	129,6	0,60	5,7
P-132	5,181	0,024	0,224	0,006	131,6	0,60	5,7
P-135	5,299	0,024	0,224	0,006	134,6	0,60	5,7
P-140	5,496	0,024	0,224	0,006	139,6	0,60	5,7
P-145	5,693	0,024	0,224	0,006	144,6	0,60	5,7
P-150	5,890	0,024	0,224	0,006	149,6	0,60	5,7
P-150A	5,886	0,024	0,331	0,006	149,5	0,60	8,4
P-155	6,083	0,024	0,331	0,006	154,5	0,60	8,4
P-160	6,280	0,024	0,331	0,006	159,5	0,60	8,4
P-165	6,476	0,024	0,331	0,006	164,5	0,60	8,4
P-170	6,673	0,024	0,331	0,006	169,5	0,60	8,4
P-175	6,870	0,024	0,331	0,006	174,5	0,60	8,4
P-180	7,067	0,024	0,331	0,006	179,5	0,60	8,4
P-185	7,264	0,031	0,331	0,006	184,5	0,80	8,4
P-190	7,461	0,031	0,331	0,006	189,5	0,80	8,4



**14. C. JIS O-ring Sizes** \* See page 203 for tolerances

JIS Sizes							
P-195	7,657	0,031	0,331	0,006	194,5	0,80	8,4
P-200	7,854	0,031	0,331	0,006	199,5	0,80	8,4
P-205	8,051	0,031	0,331	0,006	204,5	0,80	8,4
P-209	8,209	0,031	0,331	0,006	208,5	0,80	8,4
P-210	8,248	0,031	0,331	0,006	209,5	0,80	8,4
P-215	8,445	0,031	0,331	0,006	214,5	0,80	8,4
P-220	8,642	0,031	0,331	0,006	219,5	0,80	8,4
P-225	8,839	0,031	0,331	0,006	224,5	0,80	8,4
P-230	9,035	0,031	0,331	0,006	229,5	0,80	8,4
P-235	9,232	0,031	0,331	0,006	234,5	0,80	8,4
P-240	9,429	0,031	0,331	0,006	239,5	0,80	8,4
P-245	9,626	0,031	0,331	0,006	244,5	0,80	8,4
P-250	9,823	0,031	0,331	0,006	249,5	0,80	8,4
P-255	10,020	0,031	0,331	0,006	254,5	0,80	8,4
P-260	10,217	0,031	0,331	0,006	259,5	0,80	8,4
P-265	10,413	0,031	0,331	0,006	264,5	0,80	8,4
P-270	10,610	0,031	0,331	0,006	269,5	0,80	8,4
P-275	10,807	0,031	0,331	0,006	274,5	0,80	8,4
P-280	11,004	0,031	0,331	0,006	279,5	0,80	8,4
P-285	11,201	0,031	0,331	0,006	284,5	0,80	8,4
P-290	11,398	0,031	0,331	0,006	289,5	0,80	8,4
P-295	11,594	0,031	0,331	0,006	294,5	0,80	8,4
P-300	11,791	0,031	0,331	0,006	299,5	0,80	8,4
P-315	12,382	0,039	0,331	0,006	314,5	1,00	8,4
P-320	12,579	0,039	0,331	0,006	319,5	1,00	8,4
P-335	13,169	0,039	0,331	0,006	334,5	1,00	8,4
P-340	13,366	0,039	0,331	0,006	339,5	1,00	8,4
P-355	13,957	0,039	0,331	0,006	354,5	1,00	8,4
P-360	14,154	0,039	0,331	0,006	359,5	1,00	8,4
P-375	14,744	0,039	0,331	0,006	374,5	1,00	8,4
P-385	15,138	0,039	0,331	0,006	384,5	1,00	8,4
P-400	15,728	0,039	0,331	0,006	399,5	1,00	8,4
G-25	0,961	0,006	0,122	0,004	24,4	0,15	3,1
G-30	1,157	0,006	0,122	0,004	29,4	0,15	3,1
G-35	1,354	0,006	0,122	0,004	34,4	0,15	3,1
G-40	1,551	0,006	0,122	0,004	39,4	0,15	3,1
G-45	1,748	0,010	0,122	0,004	44,4	0,25	3,1
G-50	1,945	0,010	0,122	0,004	49,4	0,25	3,1
G-55	2,142	0,010	0,122	0,004	54,4	0,25	3,1
G-60	2,339	0,010	0,122	0,004	59,4	0,25	3,1
G-65	2,535	0,010	0,122	0,004	64,4	0,25	3,1
G-70	2,732	0,010	0,122	0,004	69,4	0,25	3,1
G-75	2,929	0,016	0,122	0,004	74,4	0,40	3,1
G-80	3,126	0,016	0,122	0,004	79,4	0,40	3,1
G-85	3,323	0,016	0,122	0,004	84,4	0,40	3,1
G-90	3,520	0,016	0,122	0,004	89,4	0,40	3,1
G-95	3,717	0,016	0,122	0,004	94,4	0,40	3,1
G-100	3,913	0,016	0,122	0,004	99,4	0,40	3,1
G-105	4,110	0,016	0,122	0,004	104,4	0,40	3,1
G-110	4,307	0,016	0,122	0,004	109,4	0,40	3,1
G-115	4,504	0,016	0,122	0,004	114,4	0,40	3,1
G-120	4,701	0,016	0,122	0,004	119,4	0,40	3,1

### 14. C. JIS O-ring Sizes \* See page 203 for tolerances

JIS Sizes							
G-125	4,898	0,016	0,122	0,004	124,4	0,40	3,1
G-130	5,094	0,024	0,122	0,004	129,4	0,60	3,1
G-135	5,291	0,024	0,122	0,004	134,4	0,60	3,1
G-140	5,488	0,024	0,122	0,004	139,4	0,60	3,1
G-145	5,685	0,024	0,122	0,004	144,4	0,60	3,1
G-150	5,878	0,024	0,224	0,006	149,3	0,60	5,7
G-155	6,075	0,024	0,224	0,006	154,3	0,60	5,7
G-160	6,272	0,024	0,224	0,006	159,3	0,60	5,7
G-165	6,469	0,024	0,224	0,006	164,3	0,60	5,7
G-170	6,665	0,024	0,224	0,006	169,3	0,60	5,7
G-175	6,862	0,024	0,224	0,006	174,3	0,60	5,7
G-180	7,059	0,024	0,224	0,006	179,3	0,60	5,7
G-185	7,256	0,031	0,224	0,006	184,3	0,80	5,7
G-190	7,453	0,031	0,224	0,006	189,3	0,80	5,7
G-195	7,650	0,031	0,224	0,006	194,3	0,80	5,7
G-200	7,846	0,031	0,224	0,006	199,3	0,80	5,7
G-210	8,240	0,031	0,224	0,006	209,3	0,80	5,7
G-220	8,634	0,031	0,224	0,006	219,3	0,80	5,7
G-230	9,028	0,031	0,224	0,006	229,3	0,80	5,7
G-240	9,421	0,031	0,224	0,006	239,3	0,80	5,7
G-250	9,815	0,031	0,224	0,006	249,3	0,80	5,7
G-255	10,012	0,031	0,224	0,006	254,3	0,80	5,7
G-260	10,209	0,031	0,224	0,006	259,3	0,80	5,7
G-270	10,602	0,031	0,224	0,006	269,3	0,80	5,7
G-280	10,996	0,031	0,224	0,006	279,3	0,80	5,7
G-290	11,390	0,031	0,224	0,006	289,3	0,80	5,7
G-300	11,783	0,031	0,224	0,006	299,3	0,80	5,7
V-15	0,571	0,006	0,157	0,004	14,5	0,15	4,0
V-24	0,925	0,006	0,157	0,004	23,5	0,15	4,0
V-34	1,319	0,006	0,157	0,004	33,5	0,15	4,0
V-40	1,555	0,006	0,157	0,004	39,5	0,15	4,0
V-55	2,146	0,010	0,157	0,004	54,5	0,25	4,0
V-70	2,717	0,010	0,157	0,004	69,0	0,25	4,0
V-85	3,307	0,016	0,157	0,004	84,0	0,40	4,0
V-100	3,898	0,016	0,157	0,004	99,0	0,40	4,0
V-120	4,685	0,016	0,157	0,004	119,0	0,40	4,0
V-150	5,846	0,024	0,157	0,004	148,5	0,60	4,0
V-175	6,811	0,024	0,157	0,004	173,0	0,60	4,0
V-225	8,760	0,031	0,236	0,006	222,5	0,80	6,0
V-275	10,709	0,031	0,236	0,006	272,0	0,80	6,0
V-325	12,657	0,039	0,236	0,006	321,5	1,00	6,0
V-380	14,803	0,039	0,236	0,006	376,0	1,00	6,0
V-430	16,752	0,047	0,236	0,006	425,5	1,20	6,0
V-480	18,701	0,047	0,394	0,012	475,0	1,20	10,0
V-530	20,650	0,063	0,394	0,012	524,5	1,60	10,0
V-585	22,795	0,063	0,394	0,012	579,0	1,60	10,0
V-640	24,941	0,063	0,394	0,012	633,5	1,60	10,0
V-690	26,890	0,063	0,394	0,012	683,0	1,60	10,0
V-740	28,839	0,079	0,394	0,012	732,5	2,00	10,0
V-790	30,787	0,079	0,394	0,012	782,0	2,00	10,0
V-845	32,933	0,079	0,394	0,012	836,5	2,00	10,0
V-950	37,028	0,098	0,394	0,012	940,5	2,50	10,0
V-1055	41,102	0,118	0,394	0,012	1044,0	3,00	10,0

### 15. Tolerances and Surface Imperfections

Size tolerances and surface imperfections on O-rings are influenced by the tolerance, finish, and cleanliness of the mold cavities from which they are produced. These tolerances have been specified in the Aerospace Standard AS 568A and AS 871 A, DIN Standard 3771 Part 3, ISO 3601 Part 3, and MIL-STD-413C.

Size tolerances and surface imperfections are formed during production of O-rings by several causes:

- inaccurate temperatures
- inclusion of air
- inaccurate installation of the mold
- inaccurate de-burring
- insufficient flow of the elastomer.

Typical limited defects in O-rings can be:

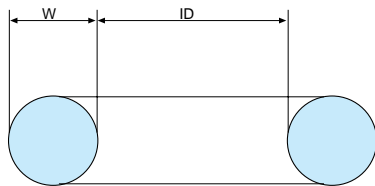

Dimensional tolerance

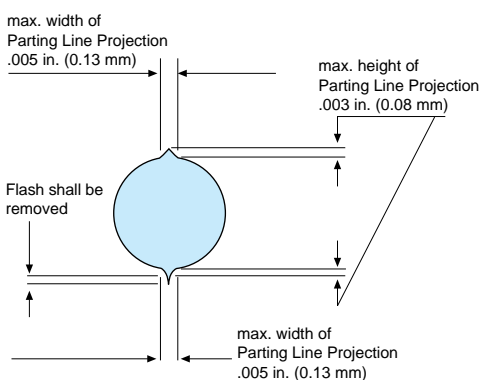

Maximum Permissible Parting Line Projection

#### Dimensional Tolerance

The finished dimensions for inner diameter and cross section of the O-ring shall conform to those quoted in the relevant standards. Variations in finished shape of section shall also be within the cross sectional tolerances specified in the relevant standards.

#### Parting Line Projection

This projection, a continuous ridge of material situated on the parting line of the mold, caused by worn or otherwise excessively rounded mold edges shall not exceed .003 in. (0,08 mm) high or .005 in. (0,13 mm) wide. The parting line projection may extend beyond the maximum cross section diameter.

#### Flash

A very thin gage, sometimes film-like material, which extends from the parting line projection, shall be removed.

### 15. Tolerances and Surface Imperfections

#### Off Register and Mismatch (Offset)

Off register of the preformed O-ring resulting from the two halves of the mold cavities being out of line, and mismatch of the O-ring resulting from one half of the mold cavity being larger than the other shall not exceed .003 in. (0,08 mm) measured at the position of maximum offset on the molded O-ring. This shall not deviate from the nominal section of the ring in excess of the drawing tolerances.

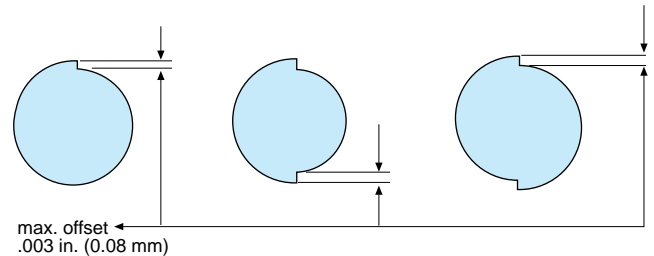

Forms of off register and mismatch

#### Combined Molding Offset (Off Register and/or Mismatch) and Parting Line Projection

The combination of parting line projection and offset, shall not exceed .003 in. (0,08 mm) high when measured at the position of maximum offset. It is permissible for this combined offset and parting line projection to extend beyond the maximum cross section diameter.

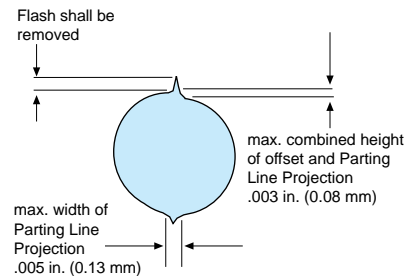

Combined offset (off register and/or mismatch) and parting line projection

#### Flats

Flats, resulting from the removal of flash on the inner and outer axial dimensions of an O-ring, shall not exceed a depth of .003 in. (0,08 mm) and shall not cause deviation from the nominal section of the O-ring in excess of the drawing tolerances, i.e. when the cross sectional diameter is on its lower limit no flatting is permissible. Non-continuous flats shall be blended out smoothly.

#### Backgrind

A torn or gouged condition (recess) occurring at the mold parting lines, caused by thermal expansion over a sharp mold edge or by premature cure.

#### Parting line Indentation

A shallow saucer-like recess, sometimes triangular, located on the parting line OD or ID and may have random orientation. Caused by a deformity on the mold edge.

#### Inclusions and Indentations

Any extraneous embedded foreign matter is unacceptable. Depressions resulting from removal thereof must not exceed defined limits.

#### Non-Fill

An irregular flat spot or ribbon-like strip, generally having a coarser texture than the normal O-ring surface. Also a recessed wedge resembling a halfmoon.

#### Mold Deposit Defects

Surface indentations, irregular in shape, and with rough surface texture are caused by a build up of hardened deposits in the mold cavity.

#### Flow Marks

A flow line, knit mark, or delamination, caused by poor knitting.

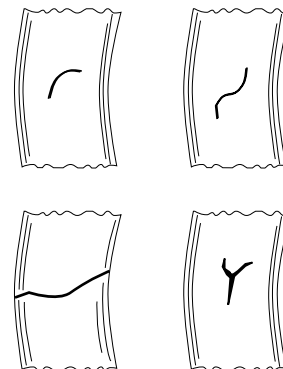

### 15. Tolerances and Surface Imperfections

Shape and Surface Deviations in O-ring Seals According to ISO 3601-3

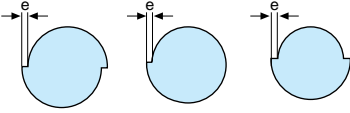
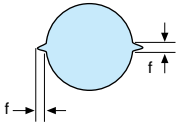
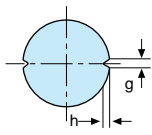
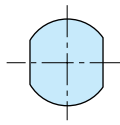
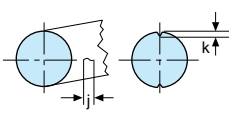
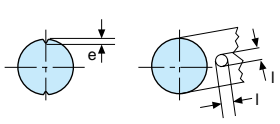
Type of Deviation	Schematic Representation	Measurement	Type Characteristics N d2 according to ISO 3601-1				
			1,78	2,62	3,53	5,33	6,99
			Largest measure				
Shoulder and Shape Deformation		e	0,08	0,10	0,13	0,15	0,15
Bead, Ridge, and Shoulder combined		f	0,10	0,12	0,14	0,16	0,18
Grooving		g	0,18	0,27	0,36	0,53	0,70
		h	0,08	0,08	0,10	0,10	0,13
Ridge Removal Area		-	Departures from round cross-sections are permitted if the flat area transitions evenly into the curve, and d2 is maintained				
Flow lines (radial spread is not permissible)		j	0,05 x d1* or**				
		k	1,5	1,5	6,5	6,5	6,5
Flow lines (radial spread is not permissible)		l	0,60	0,80	1,00	1,30	1,70
		depth m	0,08	0,08	0,10	0,10	0,13
Foreign Bodies	-	-	Not permitted				

\* d1 = inside diameter.

\*\* According to which amount is the larger.

All dimensions in mm.

### 15. Tolerances and Surface Imperfections

Shape and Surface Deviations in O-ring Seals According to ISO 3601-3

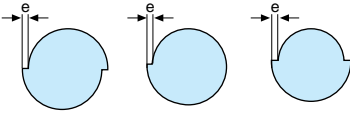
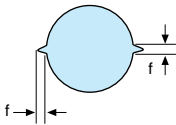
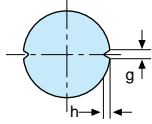
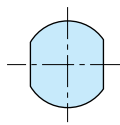
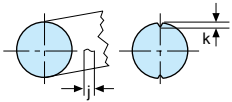
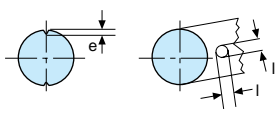
Type of Deviation	Schematic Representation	Measurement	Type Characteristics S d2 according to ISO 3601-1				
			1,78	2,62	3,53	5,33	6,99
			Largest measure				
Shoulder and Shape Deformation		e	0,08	0,08	0,10	0,12	0,13
Bead, Ridge, and Shoulder combined		f	0,10	0,10	0,13	0,15	0,15
Grooving		g	0,10	0,15	0,20	0,20	0,30
		h	0,05	0,08	0,10	0,10	0,13
Ridge Removal Area		-	Departures from round cross-sections are permitted if the flat area transitions evenly into the curve, and d2 is maintained				
Flow lines (radial spread is not permissible)		j	0,03 x d1* or**				
		k	1,5	1,5	5,0	5,0	5,0
Flow lines (radial spread is not permissible)		l	0,15	0,25	0,40	0,63	1,0
		depth m	0,08	0,08	0,10	0,10	0,13
Foreign Bodies	-	-	Not permitted				

\* d1 = inside diameter.

\*\* According to which amount is the larger.

All dimensions in mm.

## 15. Tolerances on cross section

**Tolerances on cross section (W) for O-rings acc. AS568A - inches**

.070	+/- .003	.139	+/- .004	.275	+/- .006
.103	+/- .003	.210	+/- .005		

**Tolerances on cross section (W) for O-rings acc. ISO 3601-1 class B - millimeters**

Cross Section (W)	Tolerance
0,80 < W ≤ 2,25	+/-0,08
2,25 < W ≤ 3,15	+/-0,09
3,15 < W ≤ 4,50	+/-0,10
4,50 < W ≤ 6,30	+/-0,13
6,30 < W ≤ 8,40	+/-0,15

**Tolerances on cross section (W) for O-rings - inches**

.040	+/- .003	.118	+/- .003	.275	+/- .006
.059	+/- .003	.138	+/- .004	.315	+/- .007
.063	+/- .003	.139	+/- .004	.330	+/- .007
.070	+/- .003	.142	+/- .004	.354	+/- .008
.075	+/- .003	.157	+/- .004	.394	+/- .008
.079	+/- .003	.177	+/- .004	> .394	+/-1,8% to +/- .008
.095	+/- .003	.197	+/- .005		
.100	+/- .003	.210	+/- .005		
.103	+/- .003	.224	+/- .006		
.106	+/- .003	.236	+/- .006		

### 15. Tolerances on inside diameter for O-rings

Tolerances on inside diameter for o-rings with non standard metric sizes according to ISO 3601 Class B will be calculated using the following formula (values in millimetres):

$$\Delta ID = \pm[(ID^{0,95} \times 0,009) + 0,011]$$

The next table shows the tolerances resulting from the formula.

**Tolerances on Inside Diameter for O-rings acc. ISO 3601-1 Class B - millimetres**

O-ring ID	Tolerance	O-ring ID	Tolerance	O-ring ID	Tolerance	O-ring ID	Tolerance
1,50 - 1,71	±0,12	56,42 - 57,84	±0,53	116,28 - 117,75	±0,94	177,80 - 179,31	±1,35
1,72 - 2,93	±0,13	57,85 - 59,27	±0,54	117,76 - 119,24	±0,95	179,32 - 180,82	±1,36
2,94 - 4,17	±0,14	59,28 - 60,71	±0,55	119,25 - 120,72	±0,96	180,83 - 182,34	±1,37
4,18 - 5,44	±0,15	60,72 - 62,14	±0,56	120,73 - 122,21	±0,97	182,35 - 183,86	±1,38
5,45 - 6,72	±0,16	62,15 - 63,58	±0,57	122,22 - 123,70	±0,98	183,87 - 185,38	±1,39
6,73 - 8,01	±0,17	63,59 - 65,02	±0,58	123,71 - 125,19	±0,99	185,39 - 186,89	±1,40
8,02 - 9,31	±0,18	65,03 - 66,47	±0,59	125,20 - 126,68	±1,00	186,90 - 188,41	±1,41
9,32 - 10,62	±0,19	66,48 - 67,91	±0,60	126,69 - 128,17	±1,01	188,42 - 189,93	±1,42
10,63 - 11,94	±0,20	67,92 - 69,35	±0,61	128,18 - 129,66	±1,02	189,94 - 191,45	±1,43
11,95 - 13,27	±0,21	69,36 - 70,80	±0,62	129,67 - 131,15	±1,03	191,46 - 192,98	±1,44
13,28 - 14,61	±0,22	70,81 - 72,25	±0,63	131,16 - 132,64	±1,04	192,99 - 194,50	±1,45
14,62 - 15,95	±0,23	72,26 - 73,70	±0,64	132,65 - 134,14	±1,05	194,51 - 196,02	±1,46
15,96 - 17,29	±0,24	73,71 - 75,15	±0,65	134,15 - 135,63	±1,06	196,03 - 197,54	±1,47
17,30 - 18,64	±0,25	75,16 - 76,60	±0,66	135,64 - 137,13	±1,07	197,55 - 199,07	±1,48
18,65 - 20,00	±0,26	76,61 - 78,05	±0,67	137,14 - 138,62	±1,08	199,08 - 200,59	±1,49
20,01 - 21,36	±0,27	78,06 - 79,51	±0,68	138,63 - 140,12	±1,09	200,60 - 202,12	±1,50
21,37 - 22,73	±0,28	79,52 - 80,97	±0,69	140,13 - 141,62	±1,10	202,13 - 203,64	±1,51
22,74 - 24,10	±0,29	80,98 - 82,42	±0,70	141,63 - 143,12	±1,11	203,65 - 205,17	±1,52
24,11 - 25,47	±0,30	82,43 - 83,88	±0,71	143,13 - 144,62	±1,12	205,18 - 206,69	±1,53
25,48 - 26,85	±0,31	83,89 - 85,34	±0,72	144,63 - 146,12	±1,13	206,70 - 208,22	±1,54
26,86 - 28,23	±0,32	85,35 - 86,80	±0,73	146,13 - 147,62	±1,14	208,23 - 209,75	±1,55
28,24 - 29,61	±0,33	86,81 - 88,27	±0,74	147,63 - 149,12	±1,15	209,76 - 211,28	±1,56
29,62 - 31,00	±0,34	88,28 - 89,73	±0,75	149,13 - 150,62	±1,16	211,29 - 212,81	±1,57
31,01 - 32,39	±0,35	89,74 - 91,20	±0,76	150,63 - 152,13	±1,17	212,82 - 214,34	±1,58
32,40 - 33,78	±0,36	91,21 - 92,66	±0,77	152,14 - 153,63	±1,18	214,35 - 215,87	±1,59
33,79 - 35,18	±0,37	92,67 - 94,13	±0,78	153,64 - 155,13	±1,19	215,88 - 217,40	±1,60
35,19 - 36,58	±0,38	94,14 - 95,60	±0,79	155,14 - 156,64	±1,20	217,41 - 218,93	±1,61
36,59 - 37,98	±0,39	95,61 - 97,07	±0,80	156,65 - 158,15	±1,21	218,94 - 220,46	±1,62
37,99 - 39,38	±0,40	97,08 - 98,54	±0,81	158,16 - 159,65	±1,22	220,47 - 221,99	±1,63
39,39 - 40,79	±0,41	98,55 - 100,01	±0,82	159,66 - 161,16	±1,23	222,00 - 223,52	±1,64
40,80 - 42,20	±0,42	100,02 - 101,48	±0,83	161,17 - 162,67	±1,24	223,53 - 225,06	±1,65
42,21 - 43,61	±0,43	101,49 - 102,96	±0,84	162,68 - 164,18	±1,25	225,07 - 226,59	±1,66
43,62 - 45,02	±0,44	102,97 - 104,43	±0,85	164,19 - 165,69	±1,26	226,60 - 228,12	±1,67
45,03 - 46,44	±0,45	104,44 - 105,91	±0,86	165,70 - 167,20	±1,27	228,13 - 229,66	±1,68
46,45 - 47,86	±0,46	105,92 - 107,39	±0,87	167,21 - 168,71	±1,28	229,67 - 231,19	±1,69
47,87 - 49,28	±0,47	107,40 - 108,86	±0,88	168,72 - 170,22	±1,29	231,20 - 232,73	±1,70
49,29 - 50,70	±0,48	108,87 - 110,34	±0,89	170,23 - 171,73	±1,30	232,74 - 234,27	±1,71
50,71 - 52,12	±0,49	110,35 - 111,82	±0,90	171,74 - 173,25	±1,31	234,28 - 235,80	±1,72
52,13 - 53,55	±0,50	111,83 - 113,30	±0,91	173,26 - 174,76	±1,32	235,81 - 237,34	±1,73
53,56 - 54,98	±0,51	113,31 - 114,79	±0,92	174,77 - 176,28	±1,33	237,35 - 238,88	±1,74
54,99 - 56,41	±0,52	114,80 - 116,27	±0,93	176,29 - 177,79	±1,34	238,89 - 240,42	±1,75



## 15. Tolerances on inside diameter for O-rings

**Tolerances on Inside Diameter for O-rings acc. ISO 3601-1 Class B - millimetres**

O-ring ID	Tolerance	O-ring ID	Tolerance	O-ring ID	Tolerance	O-ring ID	Tolerance
240,43 - 241,95	±1,76	313,23 - 314,78	±2,23	386,90 - 388,47	±2,70	461,29 - 462,87	±3,17
241,96 - 243,49	±1,77	314,79 - 316,34	±2,24	388,48 - 390,05	±2,71	462,88 - 464,46	±3,18
243,50 - 245,03	±1,78	316,35 - 317,90	±2,25	390,06 - 391,62	±2,72	464,47 - 466,05	±3,19
245,04 - 246,57	±1,79	317,91 - 319,46	±2,26	391,63 - 393,20	±2,73	466,06 - 467,64	±3,20
246,58 - 248,11	±1,80	319,47 - 321,02	±2,27	393,21 - 394,78	±2,74	467,65 - 469,23	±3,21
248,12 - 249,66	±1,81	321,03 - 322,58	±2,28	394,79 - 396,35	±2,75	469,24 - 470,82	±3,22
249,67 - 251,20	±1,82	322,59 - 324,15	±2,29	396,36 - 397,93	±2,76	470,83 - 472,41	±3,23
251,21 - 252,74	±1,83	324,16 - 325,71	±2,30	397,94 - 399,51	±2,77	472,42 - 474,00	±3,24
252,75 - 254,28	±1,84	325,72 - 327,27	±2,31	399,52 - 401,09	±2,78	474,01 - 475,59	±3,25
254,29 - 255,82	±1,85	327,28 - 328,83	±2,32	401,10 - 402,66	±2,79	475,60 - 477,19	±3,26
255,83 - 257,37	±1,86	328,84 - 330,39	±2,33	402,67 - 404,24	±2,80	477,20 - 478,78	±3,27
257,38 - 258,91	±1,87	330,40 - 331,96	±2,34	404,25 - 405,82	±2,81	478,79 - 480,37	±3,28
258,92 - 260,46	±1,88	331,97 - 333,52	±2,35	405,83 - 407,40	±2,82	480,38 - 481,96	±3,29
260,47 - 262,00	±1,89	333,53 - 335,09	±2,36	407,41 - 408,98	±2,83	481,97 - 483,56	±3,30
262,01 - 263,55	±1,90	335,10 - 336,65	±2,37	408,99 - 410,56	±2,84	483,57 - 485,15	±3,31
263,56 - 265,09	±1,91	336,66 - 338,21	±2,38	410,57 - 412,14	±2,85	485,16 - 486,74	±3,32
265,10 - 266,64	±1,92	338,22 - 339,78	±2,39	412,15 - 413,72	±2,86	486,75 - 488,34	±3,33
266,65 - 268,18	±1,93	339,79 - 341,35	±2,40	413,73 - 415,30	±2,87	488,35 - 489,93	±3,34
268,19 - 269,73	±1,94	341,36 - 342,91	±2,41	415,31 - 416,89	±2,88	489,94 - 491,52	±3,35
269,74 - 271,28	±1,95	342,92 - 344,48	±2,42	416,90 - 418,47	±2,89	491,53 - 493,12	±3,36
271,29 - 272,83	±1,96	344,49 - 346,04	±2,43	418,48 - 420,05	±2,90	493,13 - 494,71	±3,37
272,84 - 274,38	±1,97	346,05 - 347,61	±2,44	420,06 - 421,63	±2,91	494,72 - 496,31	±3,38
274,39 - 275,92	±1,98	347,62 - 349,18	±2,45	421,64 - 423,21	±2,92	496,32 - 497,90	±3,39
275,93 - 277,47	±1,99	349,19 - 350,75	±2,46	423,22 - 424,80	±2,93	497,91 - 499,50	±3,40
277,48 - 279,02	±2,00	350,76 - 352,31	±2,47	424,81 - 426,38	±2,94	499,51 - 501,10	±3,41
279,03 - 280,57	±2,01	352,32 - 353,88	±2,48	426,39 - 427,96	±2,95	501,11 - 502,69	±3,42
280,58 - 282,12	±2,02	353,89 - 355,45	±2,49	427,97 - 429,55	±2,96	502,70 - 504,29	±3,43
282,13 - 283,68	±2,03	355,46 - 357,02	±2,50	429,56 - 431,13	±2,97	504,30 - 505,89	±3,44
283,69 - 285,23	±2,04	357,03 - 358,59	±2,51	431,14 - 432,71	±2,98	505,90 - 507,48	±3,45
285,24 - 286,78	±2,05	358,60 - 360,16	±2,52	432,72 - 434,30	±2,99	507,49 - 509,08	±3,46
286,79 - 288,33	±2,06	360,17 - 361,73	±2,53	434,31 - 435,88	±3,00	509,09 - 510,68	±3,47
288,34 - 289,88	±2,07	361,74 - 363,30	±2,54	435,89 - 437,47	±3,01	510,69 - 512,27	±3,48
289,89 - 291,44	±2,08	363,31 - 364,87	±2,55	437,48 - 439,05	±3,02	512,28 - 513,87	±3,49
291,45 - 292,99	±2,09	364,88 - 366,44	±2,56	439,06 - 440,64	±3,03	513,88 - 515,47	±3,50
293,00 - 294,54	±2,10	366,45 - 368,01	±2,57	440,65 - 442,22	±3,04	515,48 - 517,07	±3,51
294,55 - 296,10	±2,11	368,02 - 369,58	±2,58	442,23 - 443,81	±3,05	517,08 - 518,67	±3,52
296,11 - 297,65	±2,12	369,59 - 371,16	±2,59	443,82 - 445,40	±3,06	518,68 - 520,27	±3,53
297,66 - 299,21	±2,13	371,17 - 372,73	±2,60	445,41 - 446,98	±3,07	520,28 - 521,87	±3,54
299,22 - 300,76	±2,14	372,74 - 374,30	±2,61	446,99 - 448,57	±3,08	521,88 - 523,46	±3,55
300,77 - 302,32	±2,15	374,31 - 375,87	±2,62	448,58 - 450,16	±3,09	523,47 - 525,06	±3,56
302,33 - 303,88	±2,16	375,88 - 377,45	±2,63	450,17 - 451,75	±3,10	525,07 - 526,66	±3,57
303,89 - 305,43	±2,17	377,46 - 379,02	±2,64	451,76 - 453,33	±3,11	526,67 - 528,26	±3,58
305,44 - 306,99	±2,18	379,03 - 380,59	±2,65	453,34 - 454,92	±3,12	528,27 - 529,86	±3,59
307,00 - 308,55	±2,19	380,60 - 382,17	±2,66	454,93 - 456,51	±3,13	529,87 - 531,46	±3,60
308,56 - 310,11	±2,20	382,18 - 383,74	±2,67	456,52 - 458,10	±3,14	531,47 - 533,07	±3,61
310,12 - 311,66	±2,21	383,75 - 385,32	±2,68	458,11 - 459,69	±3,15	533,08 - 534,67	±3,62
311,67 - 313,22	±2,22	385,33 - 386,89	±2,69	459,70 - 461,28	±3,16	534,68 - 536,27	±3,63

## 15. Tolerances on inside diameter for O-rings

**Tolerances on Inside Diameter for O-rings acc. ISO 3601-1 Class B - millimetres**

O-ring ID	Tolerance	O-ring ID	Tolerance	O-ring ID	Tolerance	O-ring ID	Tolerance
536,28 - 537,87	±3,64	584,43 - 586,02	±3,94	632,77 - 634,38	±4,24	501,11 - 502,69	±3,42
537,88 - 539,47	±3,65	586,03 - 587,63	±3,95	634,39 - 635,99	±4,25	502,70 - 504,29	±3,43
539,48 - 541,07	±3,66	587,64 - 589,24	±3,96	636,00 - 637,61	±4,26	504,30 - 505,89	±3,44
541,08 - 542,68	±3,67	589,25 - 590,85	±3,97	637,62 - 639,22	±4,27	505,90 - 507,48	±3,45
542,69 - 544,28	±3,68	590,86 - 592,46	±3,98	639,23 - 640,84	±4,28	507,49 - 509,08	±3,46
544,29 - 545,88	±3,69	592,47 - 594,07	±3,99	640,85 - 642,45	±4,29	509,09 - 510,68	±3,47
545,89 - 547,48	±3,70	594,08 - 595,68	±4,00	642,46 - 644,07	±4,30	510,69 - 512,27	±3,48
547,49 - 549,09	±3,71	595,69 - 597,29	±4,01	644,08 - 645,69	±4,31	512,28 - 513,87	±3,49
549,10 - 550,69	±3,72	597,30 - 598,90	±4,02	645,70 - 647,30	±4,32	513,88 - 515,47	±3,50
550,70 - 552,29	±3,73	598,91 - 600,51	±4,03	647,31 - 648,92	±4,33	515,48 - 517,07	±3,51
552,30 - 553,90	±3,74	600,52 - 602,12	±4,04	648,93 - 650,54	±4,34	517,08 - 518,67	±3,52
553,91 - 555,50	±3,75	602,13 - 603,73	±4,05	470,83 - 472,41	±3,23	518,68 - 520,27	±3,53
555,51 - 557,11	±3,76	603,74 - 605,34	±4,06	472,42 - 474,00	±3,24	520,28 - 521,87	±3,54
557,12 - 558,71	±3,77	605,35 - 606,95	±4,07	474,01 - 475,59	±3,25	521,88 - 523,46	±3,55
558,72 - 560,32	±3,78	606,96 - 608,56	±4,08	475,60 - 477,19	±3,26	523,47 - 525,06	±3,56
560,33 - 561,92	±3,79	608,57 - 610,18	±4,09	477,20 - 478,78	±3,27	525,07 - 526,66	±3,57
561,93 - 563,53	±3,80	610,19 - 611,79	±4,10	478,79 - 480,37	±3,28	526,67 - 528,26	±3,58
563,54 - 565,13	±3,81	611,80 - 613,40	±4,11	480,38 - 481,96	±3,29	528,27 - 529,86	±3,59
565,14 - 566,74	±3,82	613,41 - 615,01	±4,12	481,97 - 483,56	±3,30	529,87 - 531,46	±3,60
566,75 - 568,34	±3,83	615,02 - 616,62	±4,13	483,57 - 485,15	±3,31	531,47 - 533,07	±3,61
568,35 - 569,95	±3,84	616,63 - 618,24	±4,14	485,16 - 486,74	±3,32	533,08 - 534,67	±3,62
569,96 - 571,56	±3,85	618,25 - 619,85	±4,15	486,75 - 488,34	±3,33	534,68 - 536,27	±3,63
571,57 - 573,16	±3,86	619,86 - 621,46	±4,16	488,35 - 489,93	±3,34	536,28 - 537,87	±3,64
573,17 - 574,77	±3,87	621,47 - 623,08	±4,17	489,94 - 491,52	±3,35	537,88 - 539,47	±3,65
574,78 - 576,38	±3,88	623,09 - 624,69	±4,18	491,53 - 493,12	±3,36	539,48 - 541,07	±3,66
576,39 - 577,98	±3,89	624,70 - 626,30	±4,19	493,13 - 494,71	±3,37	541,08 - 542,68	±3,67
577,99 - 579,59	±3,90	626,31 - 627,92	±4,20	494,72 - 496,31	±3,38	542,69 - 544,28	±3,68
579,60 - 581,20	±3,91	627,93 - 629,53	±4,21	496,32 - 497,90	±3,39	544,29 - 545,88	±3,69
581,21 - 582,81	±3,92	629,54 - 631,15	±4,22	497,91 - 499,50	±3,40	545,89 - 547,48	±3,70
582,82 - 584,42	±3,93	631,16 - 632,76	±4,23	499,51 - 501,10	±3,41	547,49 - 549,09	±3,71

### 15. Tolerances on inside diameter for O-rings

The tolerances on O-rings are different from those for molded parts. Molded parts tolerances are according to DIN ISO 3302-1 and have different classes, depending on the application. The following chart indicates these classes.

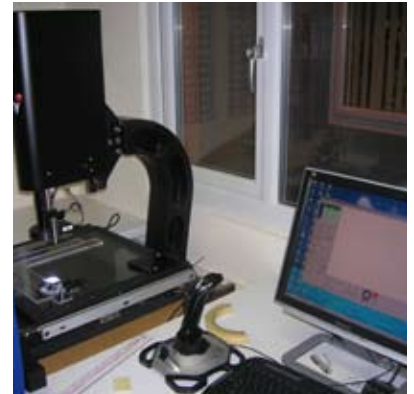
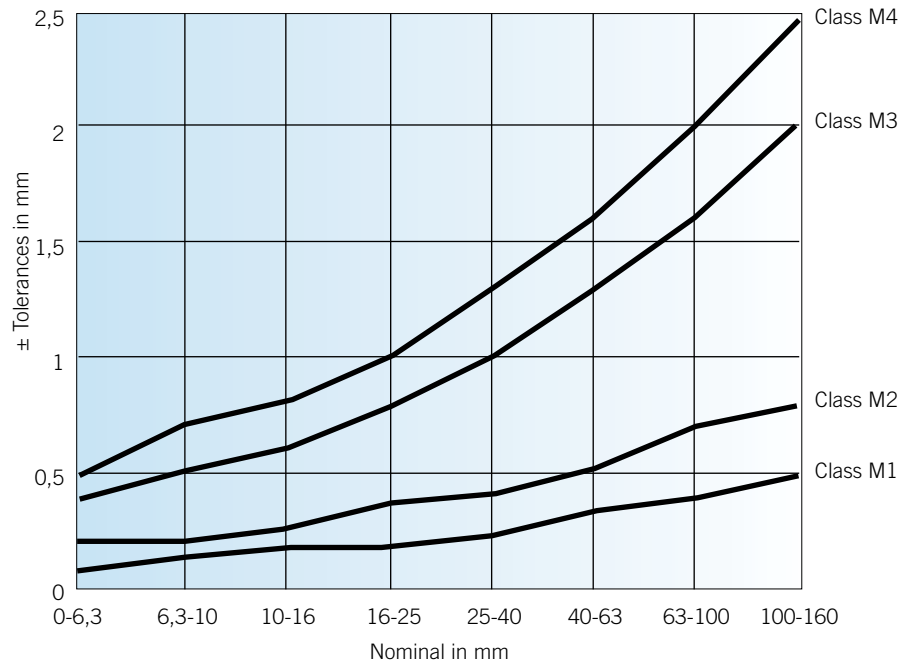

### Optical surface measurements

Due to modern Basler machines ERIKS can control tolerances and surface imperfections to many different international standards. These machines are able to control O-rings up to 63 mm outside diameter.

Ask the local ERIKS representative for more information.

### Principle:

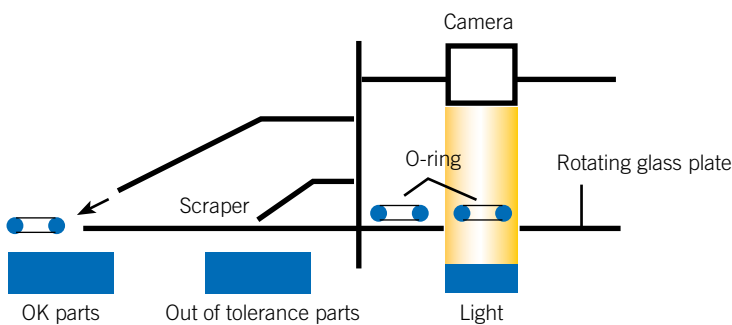

### 16. Vulc-O-rings and O-ring Cords

#### Vulc-O-rings

One of our oldest and most popular products is the Hot Vulcanised Cord ring ('Vulc-O-ring').

Eriks has developed a very successful method of producing O-rings from extruded cord to a very high technical standard. The most important factors affecting the



quality of this product are the mechanical characteristics and dimensional accuracy of the extruded cord stock. Over recent years Eriks has formulated special compounds which give very low compression set figures which are critical for high quality vulcanising.

In addition to this the in-house extrusion lines are all laser controlled for dimensional accuracy and the standard extruded finish cord tolerances are often tighter than ISO 330 2 E1. Eriks offers the optional 'close-tol' cord



which can have the incredible tolerance of just +/- 0.05mm (0.002") and a super smooth surface finish.

#### Joint Tensile Strengths

As the opposite picture shows, Eriks produces all joints by scarfing at 45°. This is very important in achieving high tensile strengths as the area of the vulcanising surface is greatly increased.

Eriks routinely conducts tensile strength tests on a regular basis to satisfy internal quality control requirements. In addition to this (by prior arrangement) production batch testing can also be provided. The testing is carried out on a custom built tensometer.



A typical joint sample is 140mm long and is held in specially designed clamps.



### 16. Vulc-O-rings and O-ring Cords

#### Joint Tensile Strengths

The joint sample is stretched until breakage occurs and, depending on material, can result in a very high elongation.

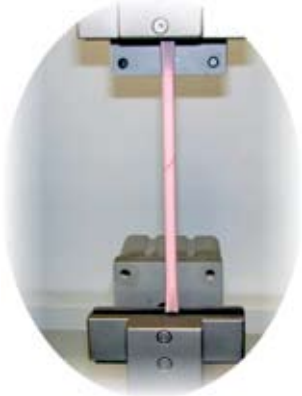

When the sample breaks it is often at the joint area. This does not infer weakness but at such high elongation, a surface imperfection around the joint area will be the point of breakage.



The break as you can see is at the joint area but at 90 degrees to the cord stock.

This detail shows that the vulcanised area has not failed and indicates a good quality vulcanisation.



After breakage the load cell transfers to computer software the data which is then analysed and expressed in graph form and as industry standard MPa tensile strength.

It is then possible to include this testing with general certification (by prior agreement).

By conducting joint tests and inserting them into the actual production schedule, Eriks can obtain a true representation of the integrity and consistency of the vulcanising process, particularly useful on higher volume orders.



### 16. Vulc-O-rings and O-ring Cords

#### Size Range

ERIKS can produce Vulc-O-rings with cross sections ranging from 1.78 mm to 25,4 mm. These will have a surface finish as extruded unless otherwise requested.

Unlike moulded O-rings, Vulc-O-rings have a limit as to how small an inside diameter that can be produced, which is regulated by the cross section. The following table shows the smallest sizes that can be produced.

1.78 mm - 8.40 mm	30 mm
9.00 mm - 12.70 mm	45 mm
13.00 mm- 15.90 mm	60 mm
18.00 mm - 19.05 mm	150 mm
20.63 mm - 25.40 mm	250 mm

Please note the price list for these small size Vulc-O-rings are more expensive because they are more difficult to manufacture.

There is however no upper limit to diameter.

The largest Vulc-O-ring Eriks has ever produced so far has been an amazing 22 meters in diameter! The only difficulty is checking the inside diameter at quality control!

#### Dimensional Tolerances

As previously mentioned, Eriks' extruded cord is unrivalled for tolerance control. Standard extruded cord betters E1 in many sections and a summary of the standard sections with their tolerance follows:

1.78	± 0.10	6.50	± 0.25
2.00	± 0.10	6.99	± 0.25
2.40	± 0.12	7.50	± 0.25
2.62	± 0.12	8.00	± 0.25
3.00	± 0.12	8.40	± 0.25
3.18	± 0.15	9.00	± 0.25
3.53	± 0.15	9.52	± 0.25
4.00	± 0.15	10.00	± 0.33
4.50	± 0.20	11.10	± 0.38
4.80	± 0.20	12.00	± 0.45
5.00	± 0.20	12.70	± 0.45
5.34	± 0.20	13.00	± 0.45
5.50	± 0.25	14.00	± 0.50
5.70	± 0.25	14.30	± 0.50
6.00	± 0.25	15.00	± 0.50
6.35	± 0.25	15.90	± 0.50

Every inch of the extruded products are checked for compliance to the above tolerances by state of the art 'laser micrometers'. This is the only way to guarantee 100% cross section diameter inspection.

Each batch of extrusion is passed through one of these laser micrometers and the laser measures the cord 250 times per second and then produces a report after each batch showing details of high, low, and average diameters.



### 16. Vulc-O-rings and O-ring Cords

Inside diameters are controlled according to ISO 3302-1 M2F as Vulc-O-rings frequently fall outside the range of diameters controlled by BS or AS standard sizes.

25mm thru 40mm	+/- 0.35
40.1mm thru 63mm	+/- 0.40
63.1mm thru 100mm	+/- 0.50
100.1mm thru 160mm	+/- 0.70

Hereafter the tolerance will be +/- 0.5% of the nominal inside diameter of the ring  
Example: inside diameter of 310.0mm tolerance = +/- 1.55mm (0.5%)

#### Benefits of Vulc-O-rings

The main benefits of utilising Vulc-O-rings are listed as follows.

- Molds are not required resulting in huge cost savings
- No upper diameter restrictions like molding
- Tolerances can be closer than molding
- No flash lines are present
- Can be used in standard housings
- Shapes other than round are possible
- Joints in some cases 90% of cord strength
- Short lead times (48 hour turn around possible)
- Hardnesses as low as 40 Shore A possible
- Hollow core and low load O-rings available
- Vacuum quality “ground finish” on demand
- Semi-com low outgassing grades with clean room packaging
- USP class VI grades available
- Metal detectable grades available

#### Restrictions of Vulc-O-rings

There are however areas where Vulc-O-rings are restrictive.

- Dynamic applications where roll may occur.
- Excessive stretching- low strength materials.
- Not competitive against moulded rings when small diameters in high volume.

#### Lead Times for Vulc-O-rings

Price list Vulc-O-rings up to 100 pcs will be shipped within seven working days from receipt of order.

Other volumes and sizes are available based on the application.

#### Materials

ERIKS maintains a standard range of materials in compound form for speedy conversion into extruded cord. This is a different policy than of holding cord on the shelf. There are more and more clients asking for current quarter cure dates and this policy ensures that the user gets this rather than cord which may have been on the shelf for longer. Other materials, colors and hardness's may be possible to special manufacture. Contact ERIKS with any requirements.

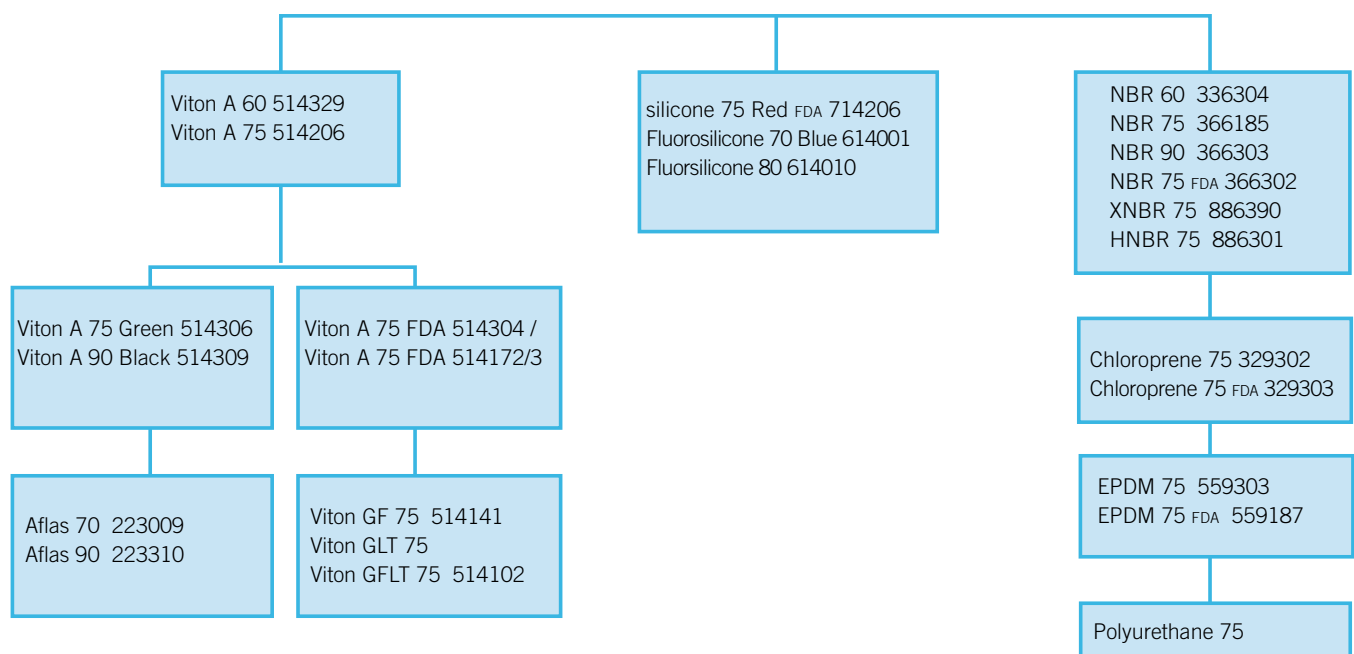

### 16. Vulc-O-rings and O-ring Cords

#### Rubber O-ring Cord

The table shows the available stock cord dimensions and elastomers. Upon request cord in special elastomers or special dimensions can be supplied.

#### Available materials:

Nitrile NBR 70 Shore A, NBR 90 Shore A, Fluorocarbon FKM 70 Shore A, FKM 75 Shore A, Neoprene CR 60 Shore A, EPDM 70 Shore A, Silicone MVQ 60 Shore A, Polyurethane AU/EU 90

Shore A, and Para NR 40 Shore A. Other elastomers, hardnesses, or special colors can also be supplied.

An O-ring splicing kit is available with the materials required for cold bonding of custom size O-rings.

Please note that vulcanized or spliced O-rings are only recommended for static applications.

For full information ask for the special brochure: Vulc-O-rings or contact the local ERIKS representative.

#### Rubber Cord

Cross section		NR Para	NBR Nitrile		Polyurethane	CR. Neoprene	EPDM	FKM fluorocarbon		MVQ Silicone		
inch	mm	40 Sh.A	70 Sh.A	90 Sh.A	90 Sh.A	60 Sh.A	70 Sh.A	70 Sh.A Original Viton	75 Sh.A 714 BF FDA/BGA	60 Sh.A 714 THT	60 Sh.A 714 MP FDA/BGA	60 Sh.A
		Tol.E2 brown	Tol.E1 black	Tol.E2 black	Tol.E2 green	Tol.E2 white	Tol.E2 black	Tol.E1 black	Tol.E1 black	Tol.E2 transp.	Tol.E2 grey	Tol.E2 grey
.063	1,60		X				X	X				
.070	1,78		X				X	X				
.079	2,00		X				X	X		X		
.094	2,40		X					X				
.098	2,50		X							X		
.103	2,62		X				X	X		X		
.118	3,00	X	X	X	X	X	X	X	X	X	X	
.128	3,25		X									
.139	3,53		X	X		X	X	X	X	X		
.157	4,00	X	X		X	X	X	X	X	X	X	X
.177	4,50		X					X				
.187	4,75							X				
.197	5,00	X	X	X	X	X	X	X	X	X	X	
.210	5,33		X				X	X	X			
.224	5,70		X				X	X	X	X		
.236	6,00	X	X	X	X	X	X	X	X	X		X
.250	6,35		X					X				
.256	6,50							X				
.276	7,00	X	X		X	X	X	X	X	X	X	X
.295	7,50		X									
.315	8,00	X	X	X	X	X	X	X	X	X	X	X
.331	8,40		X				X	X				
.354	9,00	X	X			X	X	X		X		
.374	9,50		X									
.394	10,00	X	X		X	X	X	X	X	X	X	X
.433	11,00		X				X	X				
.472	12,00	X	X			X	X	X	X	X	X	X
.512	13,00		X			X		X		X		
.551	14,00		X			X	X	X				
.571	14,50					X						
.591	15,00		X			X	X	X		X		X
.630	16,00		X			X	X	X		X		
.669	17,00											X
.709	18,00	X	X			X				X		
.787	20,00	X	X			X	X	X		X		
.866	22,00		X							X	X	X
.906	23,00										X	X
.984	25,00	X	X			X						X
1.181	30,00		X			X	X					
1.220	31,00									X		
1.260	32,00		X									
1.575	40,00		X									



### 17. O-ring Accessories

We offer 14 different O-ring boxes in Nitrile 70, Nitrile 90 and Viton® 70; in metrical, AS- and Afnor-dimensions. We also have custom-made boxes developed for your after-market. For the maintenance department we offer several “helps” for better installation and identification (Rubber-indicator, measuring device, glues, hardness-indicator, (de)installation set).



#### O-ring Splicing Kit

An O-ring splicing kit is a universal tool to prepare and repair cord rings.

The Service Kit contains 15 feet (5 meter) of NBR 70 Shore A cord in various thicknesses: .070 inch (1,78 mm), 2 mm., .103 inch (2,62 mm), 3 mm, .139 inch (3,53 mm) , 4 mm, 5 mm, .210 inch (5,33 mm), 6 mm and .275 inch (7 mm). Also included is Sicomet glue, a cutting tool, a measuring tool, scour spray etc.

It is possible to also supply the kit with Fluoroelastomer FKM cord instead of NBR.

#### O-ring Cone

With this Cone it is very easy to determine the AS-number of O-rings according to the AS-568A and metric standard.

#### Pi-Tape Measuring tape

With this metal measuring tape it is easy to determine the diameter of O-rings. There are two types: For diameters between 1 - 12 inches (20 - 300 mm), and for diameters 12 - 27 inches (300 - 700 mm).

#### Installation Tools

Tools for proper installation and disassembling of O-rings.

### 18. O-ring Kits

ERIKS offers a number of O-ring kits in NBR 70 Shore A, FKM 70 Shore A, and FKM 90 Shore A. These O-rings are in inch dimensions according AS 568A/BS 1806 and in metric dimensions according DIN 3771, SMS 1586, AFNOR 47501, and JISB2401. All O-rings are according DIN 3771/ISO 3601 tolerances. ERIKS also offers Quad-Ring®/X-Ring kits in NBR 70 Shore A.



#### Type 1

- American/British standard AS 568.
- 382 O-rings in the 30 most popular sizes.
- Available in NBR 70° shore A.

**Type 1 - American & British standard**

20 x AS 006 2,9 x 1,78	20 x AS 007 3,69 x 1,78	20 x AS 008 4,47 x 1,78	20 x AS 009 5,18 x 1,78	20 x AS 010 6,07 x 1,78	20 x AS 011 7,65 x 1,78	20 x AS 012 9,25 x 1,78	13 x AS 110 9,20 x 2,62	13 x AS 111 10,78 x 2,62
13 x AS 112 12,37 x 2,62	13 x AS 113 13,95 x 2,62	13 x AS 114 15,54 x 2,62	13 x AS 115 17,12 x 2,62	13 x AS 116 18,72 x 2,62	10 x AS 210 18,64 x 3,53	10 x AS 211 20,22 x 3,53	10 x AS 212 21,89 x 3,53	10 x AS 213 23,39 x 3,53
10 x AS 214 24,99 x 3,53	10 x AS 215 26,57 x 3,53	10 x AS 216 28,17 x 3,53	10 x AS 217 29,74 x 3,53	10 x AS 218 31,34 x 3,53	10 x AS 219 34,52 x 3,53	10 x AS 220 34,52 x 3,53	10 x AS 221 36,09 x 3,53	10 x AS 222 37,69 x 3,53
		7 x AS 325 37,47 x 5,33	7 x AS 326 40,64 x 5,33	7 x AS 327 43,82 x 5,33				

#### Type 2

- Metric standard DIN 3771.
- 425 O-rings in 30 most popular sizes.
- Available in NBR 70 Shore A.

**Type 2 - Metric**

18 x OR 3x2	18 x OR 4x2	18 x OR 5x2	18 x OR 6x2	17 x OR 7x2	17 x OR 8x2	17 x OR 10x2	14 x OR10x2.5	14x OR11x2.5	14x OR12x2.5	14x OR14x2.5	14x OR16x2.5	14x OR17x2.5	14x OR19x2.5	12x OR19x3
12 x OR 20x3	12 x OR 22x3	12 x OR 24x3	12 x OR 25x3	12 x OR 27x3	12 x OR 28x3	12 x OR 30x3	12 x OR 32x3	12 x OR 33x3	12 x OR 35x3	12 x OR 36x3	12 x OR 38x3	9 x OR 38x4	9 x OR 42x4	9 x OR 45x4

### 18. O-ring Kits

#### Type A

- American/British standard AS 568.
- 435 O-rings in 30 most popular sizes.
- Available in NBR 70 Shore A, NBR 90 Shore A, or FKM 70 Shore A.

#### Type A - American & British standard

30 x 006 (2,90 x 1,78)	30 x 007 (3,69 x 1,78)	30 x 008 (4,47 x 1,78)	30 x 009 (5,28 x 1,78)	30 x 010 (6,07 x 1,78)
30 x 011 (7,65 x 1,78)	30 x 012 (9,25 x 1,78)	20 x 013 (10,82 x 1,78)	20 x 014 (12,42 x 1,78)	10 x 015 (14,0 x 1,78)
10 x 016 (15,60 x 1,78)	10 x 017 (17,17 x 1,78)	10 x 018 (18,77 x 1,78)	15 x 110 (9,20 x 2,62)	15 x 111 (10,78 x 2,62)
15 x 112 (12,37 x 2,62)	15 x 113 (13,95 x 2,62)	10 x 114 (15,54 x 2,62)	10 x 115 (17,12 x 2,62)	10 x 116 (18,72 x 2,62)
10 x 117 (20,30 x 2,62)	5 x 118 (21,90 x 2,62)	5 x 119 (23,47 x 2,62)	5 x 210 (18,64 x 3,53)	5 x 211 (20,22 x 3,53)
5 x 212 (21,82 x 3,53)	5 x 213 (23,39 x 3,53)	5 x 214 (24,99 x 3,53)	5 x 215 (26,57 x 3,53)	5 x 216 (28,17 x 3,53)

#### Type B

- American/British standard AS 568A/BS1806.
- 295 O-rings in 24 most popular sizes (larger sizes than in Kit A).
- Available in NBR 70 Shore A, NBR 90 Shore A, or FKM 70 Shore A.

#### Type B - American & British standard

15 x 019 (20,35 x 1,78)	15 x 020 (21,95 x 1,78)	15 x 120 (25,07 x 2,62)	15 x 121 (26,65 x 2,62)	15 x 122 (28,25 x 2,62)	15 x 123 (29,82 x 2,62)
15 x 124 (31,42 x 2,62)	15 x 125 (33,0 x 2,62)	15 x 126 (34,60 x 2,62)	15 x 217 (29,74 x 3,53)	15 x 218 (31,34 x 3,53)	15 x 219 (32,92 x 3,53)
15 x 220 (34,52 x 3,53)	10 x 221 (36,09 x 3,53)	10 x 222 (37,69 x 3,53)	10 x 223 (40,87 x 3,53)	10 x 224 (44,04 x 3,53)	10 x 225 (47,22 x 3,53)
10 x 226 (50,39 x 3,53)	10 x 325 (37,47 x 5,33)	10 x 326 (40,64 x 5,33)	10 x 327 (43,82 x 5,33)	5 x 328 (46,99 x 5,33)	5 x 329 (50,17 x 5,33)

### 18. O-ring Kits

#### Type C

- Metric standard DIN 3771.
- 425 O-rings in the most popular sizes.
- Available in NBR 70 Shore A or FKM 70 Shore A.

#### Type C - DIN Metric

20 x OR 4 x 2	20 x OR 6 x 2	20 x OR 8 x 2	20 x OR 10 x 2	20 x OR 12 x 2
20 x OR 3,3 x 2,4	20 x OR 4,3 x 2,4	20 x OR 5,3 x 2,4	20 x OR 6,3 x 2,4	20 x OR 7,3 x 2,4
20 x OR 8,3 x 2,4	20 x OR 9,3 x 2,4	15 x OR 10,3 x 2,4	15 x OR 11,3 x 2,4	15 x OR 12,3 x 2,4
15 x OR 13,3 x 2,4	15 x OR 14,3 x 2,4	10 x OR 15,3 x 2,4	10 x OR 16,3 x 2,4	10 x OR 17,3 x 2,4
10 x OR 10 x 3	10 x OR 12 x 3	10 x OR 14 x 3	10 x OR 16 x 3	10 x OR 18 x 3
10 x OR 19,2 x 3	5 x OR 20 x 3	5 x OR 22 x 3	5 x OR 24 x 3	5 x OR 26,2 x 3

#### Type D

- Metric standard DIN 3771.
- 295 O-rings in the 24 most popular sizes (larger sizes than Type C).
- Available in NBR 70 Shore A or FKM 70 Shore A.

#### Type D - DIN Metric

15 x OR 18 x 2	15 x OR 20 x 2	15 x OR 25 x 3	15 x OR 26,2 x 3	15 x OR 28 x 3	15 x OR 29,2 x 3
15 x OR 32,2 x 3	15 x OR 34,2 x 3	15 x OR 36,2 x 3	15 x OR 30 x 4	15 x OR 32 x 4	15 x 34 x 4
15 x OR 35 x 4	10 x OR 38 x 4	10 x OR 40 x 4	10 x OR 42 x 4	10 x OR 45 x 4	10 x OR 46 x 4
10 x OR 48 x 4	10 x OR 35 x 5	5 x OR 40 x 5	5 x OR 45 x 5	5 x OR 48 x 5	5 x OR 50 x 5

### 18. O-ring Kits

#### Type SV

- Swedish Metric standard SMS1568.
- 425 O-rings in the 30 most popular sizes.
- Available in NBR 70 Shore A.

#### Type SV - Swedish Metric

20 x OR 8,1 x 1,6	20 x OR 9,1 x 1,6	20 x OR 10,1 x 1,6	20 x OR 11,1 x 1,6	20 x OR 12,1 x 1,6
20 x OR 13,1 x 1,6	20 x OR 14,1 x 1,6	20 x OR 15,1 x 1,6	20 x OR 16,1 x 1,6	20 x OR 5,3 x 2,4
20 x OR 6,3 x 2,4	20 x OR 7,3 x 2,4	15 x OR 8,3 x 2,4	15 x OR 9,3 x 2,4	15 x OR 10,3 x 2,4
15 x OR 11,3 x 2,4	15 x OR 12,3 x 2,4	10 x OR 13,3 x 2,4	10 x OR 14,3 x 2,4	10 x OR 15,3 x 2,4
10 x OR 16,3 x 2,4	10 x OR 17,3 x 2,4	10 x OR 19,2 x 3	10 x OR 22,2 x 3	10 x OR 24,2 x 3
10 x OR 26,2 x 3	5 x OR 29,2 x 3	5 x OR 32,2 x 3	5 x OR 34,2 x 3	5 x OR 36,2 x 3

#### Type SV-2

- Swedish Metric standard SMS1568.
- 210 O-rings in the 24 most popular sizes (larger sizes than Type SV).
- Available in NBR 70 Shore A.

#### Type SV-2 - Swedish Metric

15 x OR 15,3 x 2,4	15 x OR 16,3 x 2,4	15 x OR 17,3 x 2,4	15 x OR 32,2 x 3	15 x OR 34,2 x 3	15 x OR 36,2 x 3
10 x OR 39,2 x 3	10 x OR 42,2 x 3	10 x OR 44,2 x 3	10 x OR 49,5 x 3	10 x OR 54,5 x 3	10 x OR 59,5 x 3
5 x OR 64,5 x 3	5 x OR 69,5 x 3	5 x OR 74,5 x 3	5 x OR 79,5 x 3	5 x OR 84,5 x 3	5 x OR 89,5 x 3
5 x OR 94,5 x 3	5 x OR 99,5 x 3	5 x OR 104,5 x 3	5 x OR 44,2 x 5,7	5 x OR 49,2 x 5,7	5 x OR 54,2 x 5,7

### 18. O-ring Kits

#### Type RI

- French Metric standard AFNOR 47501.
- 485 O-rings in the 15 most popular sizes.
- Available in NBR 70 Shore A.

**Type RI - French Metric**

R0	R1	R2	R3	R4
2,4 x 1,9	2,6 x 1,9	3,4 x 1,9	4,2 x 1	4,9 x 1,9
R5	R6	R7	R8	R9
5,7 x 1,9	7,2 x 1,9	8,9 x 1,9	8,9 x 2	10,5 x 2,7
R10	R11	R12	R13	R14
12,1 x 2,7	13,6 x 2,7	15,1 x 2,7	16,9 x 2,7	18,4 x 2,7

#### Type RII

- French Metric standard AFNOR 47501.
- 295 O-rings in the 24 most popular sizes (larger sizes than Type RI).
- Available in NBR 70 Shore A.

**Type RII - French Metric**

R10	R11	R12	R13	R14	R15
12,1 x 2,7	13,6 x 2,7	15,1 x 2,7	16,9 x 2,7	18,4 x 2,7	18,3 x 3,6
R16	R17	R18	R19	R20	R21
19,8 x 3,6	21,3 x 3,6	23 x 3,6	24,6 x 3,6	26,2 x 3,6	27,8 x 3,6
R22	R23	R24	R25	R26	R27
29,3 x 3,6	30,8 x 3,6	32,5 x 3,6	34,1 x 3,6	35,6 x 3,6	37,3 x 3,6
R28	R29	R30	R31	R32	R33
37,47 x 5,33	40,64 x 5,33	43,82 x 5,33	46,99 x 5,33	50,17 x 5,33	53,34 x 5,33

### 19. Quad-Rings®/X-Rings

The sealing principle of the Quad-Ring®/X-Ring is nearly the same as the O-ring sealing. The initial sealing is achieved by the diametrical squeeze in a right angled groove. The system pressure itself creates a positive sealing force.

#### Following are some advantages of Quad-Rings®/X-Rings:

- With Quad-Rings®/X-Rings the standard grooves are deeper in comparison with O-ring glands. So the diametrical squeeze is lower than with O-rings. This makes dynamic sealing possible with reduced friction.
- The four lips of the Quad-Ring®/X-Ring create more sealing capacity and at the same time a groove for lubrication, which is very favorable for dynamic sealing.
- The most important advantage of the Quad-Ring®/X-Ring is the high stability for dynamic applications. In the situation that an O-ring rolls in the groove and creates torsion, a Quad-Ring®/X-Ring will slide with no negative results.
- More resistant to spiral failure.

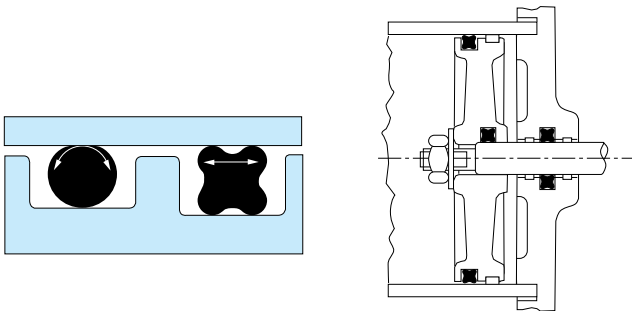

#### Standard cross sections of Quad-Rings®/X-Rings

Application Range from vacuum to 6000 psi (400 bar, 40 MPa.).  
Over 750 psi (50 bar, 5 MPa.) when used in connection with back-up-rings.

Speeds up to 1.6 ft/s (0.5 m/sec.) (reciprocating).

Surface finish is the same as with O-ring applications.

See page 7.

The temperature range is from -50°C up to +200°C (-60°F up to +400°F) depending on the elastomer or compound. As with O-rings, many Quad-Rings®/X-Rings are manufactured according to the American Standards with inch dimensions and AS. numbers. To order Quad-Rings®/X-Rings, add a "4" as a prefix to the O-ring's number.

#### Note 1:

It is recommended, especially for dynamic seals, to use the Quad-Ring®/X-Ring with the largest possible cross section or thickness because thicker rings can withstand more tolerance variance.

A 4-inch I.D. (100 mm) Quad-Ring®/X-Ring is available with cross sections of .070 (1,78 mm), .103 (2,62 mm), .139 (3,53 mm), and .210 (5,33 mm). For dynamic applications use, if there is room, the largest cross section available (.210 / 5,33 mm).

#### Note 2:

Because Quad-Ring®/X-Ring glands have deeper grooves than O-rings, standard O-ring back-up rings cannot be used. The actual groove dimensions are needed to supply the correct sized machined back-up ring.

#### Note 3:

Use FKM Quad-Rings®/X-Rings with minimum stretch because FKM Quad-Rings®/X-Rings have a smaller tolerance range than NBR Quad-Rings®/X-Rings.



.070  
(1,78 mm)



.103  
(2,62 mm)



.139  
(3,53 mm)



.210  
(5,33 mm)

### 19. A. Gland Designs for Quad-Rings®/X-Rings

#### Dynamic Applications with Quad-Rings®/X-Rings

Spiral failure sometimes occurs on reciprocating O-rings. The conditions which cause this type of failure are those which cause segments of the O-ring to slide and other segments to roll simultaneously. The twisted seal is forced by the pressure into the sharp corner at the clearance gap. Rapid stress-aging can cause a rupture of the O-ring to start adjacent to the clearance gap. Motion of the O-ring causes the rupture to penetrate about half way through the cross section. Thus, when the O-ring is removed from the gland, it returns to its original shape and the rupture appears as a tight spiral around the cross section. One of the primary causes of spiral failure is by reciprocating speeds of less than one foot (0,3 m) per minute and on low or balanced pressure components. At this low speed, the sliding, or running, seal friction is very high relative to the break-out friction.

Therefore O-ring seals are not recommended for speeds less than 1 foot (0,3 m) per minute when the pressure difference is less than 400 psi (27,5 bar). A good solution to avoid spiral failure is the use of Quad-Rings®/X-Rings.

Quad-Rings®/X-Rings are used in many dynamic applications where O-rings provide less than satisfactory performance. The Quad-Ring®/X-Ring is a four lobed seal. They are designed for improved seal lubrication and to prevent rolling of the seal, or spiral failure.

Quad-Rings®/X-Rings are dimensionally the same size corresponding to US standard AS568 O-ring numbers. Groove dimensions for the Quad-Rings®/X-Rings are slightly different however, as less squeeze is required on the seal. Less squeeze means less friction and less wear on the seal.

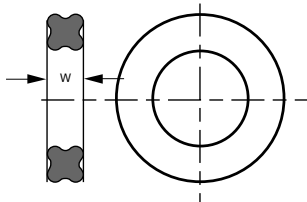

Fig. 1-36

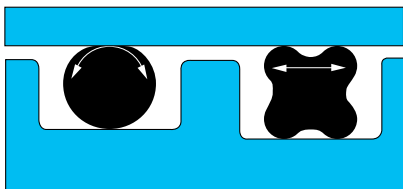

Fig. 1-37



### 19. A. Gland Designs for Quad-Rings®/X-Rings

#### Quad-Rings®/X-Rings Gland Design Static/Dynamic (INCHES)

The following table shows the groove dimensions for Quad-Rings®/X-Rings.

- If the Quad-Ring®/X-Ring swells in the application, the groove width can be enlarged up to 15% max.
- For the Quad-Rings®/X-Rings not listed, the groove dimensions are available upon request.

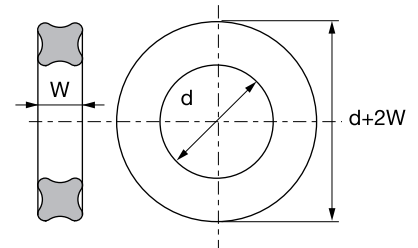
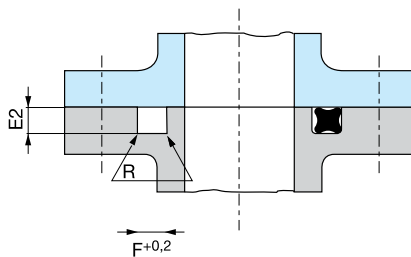
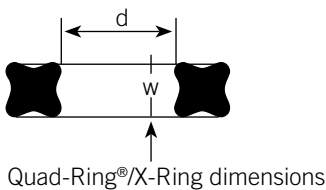
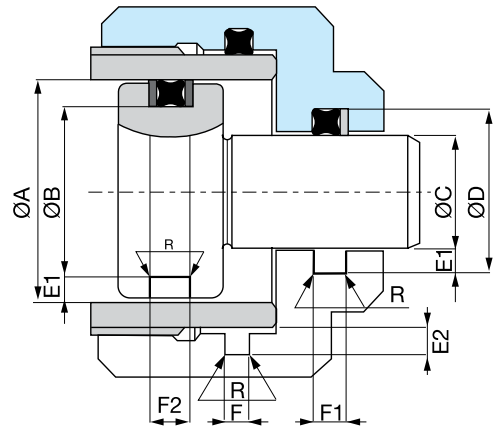

Table AS.8A Gland Dimensions (inches)

Quad-Ring® / X-Ring Size	Cross section *** W	Depth		Width **			Radius R	Max. Ø Clearance S max.
		Dynamic E1	Static E2	No backup ring F+ .008	With Backup ring F1+ .008	With Backup ring F2+ .008		
4001	.040 ± .003	.031 ± .001	.030 ± .001	.047	-	-	.004	.002
4002	.050 ± .003	.039 ± .001	.035 ± .001	.055	-	-	.006	.002
4003	.060 ± .003	.051 ± .001	.047 ± .001	.067	-	-	.010	.003
4003 1/2	.040 ± .003	.031 ± .001	.030 ± .001	.047	-	-	.004	.002
4004 - 4050	.070 ± .003	.061 ± .001	.056 ± .001	.080	.140	.200	.010	.004
4102 - 4178	.103 ± .003	.094 ± .001	.089 ± .001	.115	.170	.230	.015	.006
4201 - 4284	.139 ± .004	.128 ± .001	.122 ± .001	.155	.210	.270	.015	.006
4309 - 4395	.210 ± .005	.196 ± .001	.188 ± .001	.240	.310	.375	.020	.008
4425 - 4475	.275 ± .006	.256 ± .001	.244 ± .001	.310	.410	.510	.020	.008

#### Note:

(\*\*) In case of exceptional bending of the rod or shaft, the diameter of the bottom of the groove can be adjusted both in case of vacuum and high pressure.

(\*\*\*) Similar to O-rings, the Quad-Rings®/X-Rings need a squeeze of 10 to 15%. For critical applications in combination with small cross sections it is recommended to compare squeeze with the actual dimensions and tolerances.

### 19. A. Gland Designs for Quad-Rings®/X-Rings

#### Quad-Rings®/X-Rings Gland Design Static/Dynamic (METRIC)

The following table shows the groove dimensions for Quad-Rings®/X-Rings.

- If the Quad-Ring®/X-Ring swells in the application, the groove width can be enlarged up to 15% max.
- For the Quad-Rings®/X-Rings not listed, the groove dimensions are available upon request.

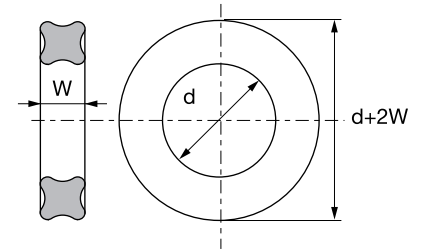
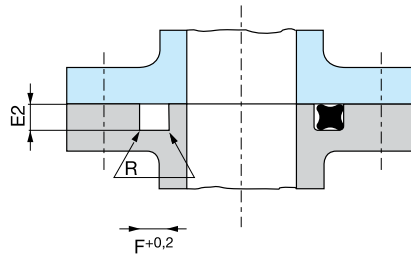
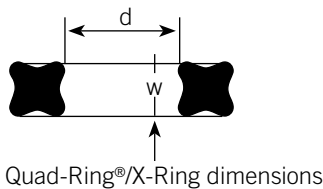
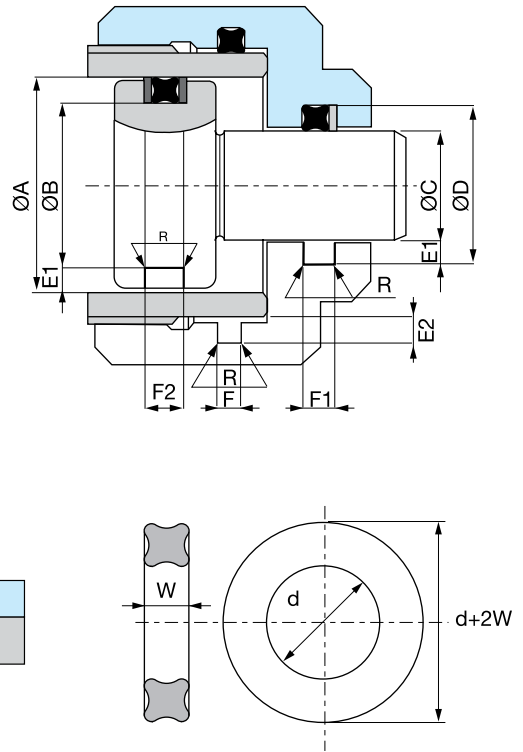

Table AS.8A Gland Dimensions (millimeters)

Quad-Ring® / X-Ring Size	Cross section *** W	Depth		Width **			Radius R	Max. Ø Clearance S max.
		Dynamic E1	Static E2	No backup ring F+ 0,2	With Backup ring F1+ 0,2	With Backup ring F2 + 0,2		
4001	1,02 + 0,08	0,8 + 0,025	0,75 + 0,025	1,2	-	-	0,1	0,05
4002	1,27 + 0,08	1,0 + 0,025	0,9 + 0,025	1,4	-	-	0,15	0,05
4003	1,52 + 0,08	1,3 + 0,025	1,2 + 0,025	1,7	-	-	0,25	0,08
4003 1/2	1,02 + 0,08	0,8 + 0,025	0,75 + 0,025	1,2	-	-	0,1	0,05
4004 - 4050	1,78 + 0,08	1,55 + 0,025	1,4 + 0,025	2,0	3,5	5,0	0,25	0,10
4102 - 4178	2,62 + 0,08	2,35 + 0,025	2,25 + 0,025	3,0	4,4	5,8	0,4	0,15
4201 - 4284	3,53 + 0,1	3,25 + 0,025	3,0 + 0,025	4,0	5,4	6,8	0,4	0,15
4309 - 4395	5,33 + 0,13	4,95 + 0,05	4,75 + 0,05	6,0	7,8	9,5	0,6	0,20
4425 - 4475	7,00 + 0,15	6,50 + 0,05	6,2 + 0,05	8,0	10,5	13,0	0,6	0,20

Other dimensions and elastomers are available upon request.

#### Note:

(\*\*) In case of exceptional bending of the rod or shaft, the diameter of the bottom of the groove can be adjusted both in case of vacuum and high pressure.

(\*\*\*) Similar to O-rings, the Quad-Rings®/X-Rings need a squeeze of 10 to 15%.

For critical applications in combination with small cross sections it is recommended to compare squeeze with the actual dimensions and tolerances.

### 19. B. Precision Quad-Rings®/X-Rings Standard Sizes

#### Nominal and Actual Dimensions

The following tables include nominal and actual dimensions, reflecting a slight built-in size reduction for effective sealing.

#### Tolerances

The standard seal tooling is dimensioned to the shrink characteristics of the standard NBR 70 hardness compound 36624. Because every rubber compound has its own shrink characteristics, slight deviations in dimensional tolerances will occur when standard seal tooling is used with materials other than the 36624 compound. The majority of the cases encountered involve rubber compounds with a higher shrink factor like a fluoroelastomer, resulting in an undersized seal. A slight adjustment in groove dimension may be required. Please contact the ERIKS Applications Engineers for tolerances when specifying materials other than the 36624 compound.

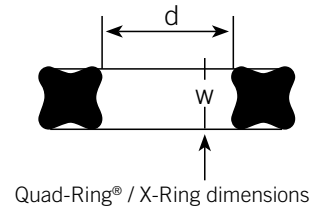

19. B. Precision Quad-Rings®/X-Rings Standard Sizes

Standard Quad-Ring® / X-Ring Sizes

Size Only		Nominal Sizes				Actual Sizes						
Part nr.	Rod	Bore	ID (in)	C/S (in)	ID (in)	+/-	ID(mm)	+/-	C/S (in)	+/-	C/S (mm)	+/-
4001	.031	.093	1/32	1/32	.029	.004	0,74	0,10	.040	.003	1,02	0,08
4002	.046	.125	3/64	3/64	.042	.004	1,07	0,10	.050	.003	1,27	0,08
4003	.062	.156	1/16	1/16	.056	.004	1,42	0,10	.060	.003	1,52	0,08
4003 1/2	.078	.141	1/16	1/32	.070	.004	1,78	0,10	.040	.003	1,02	0,08
4004	.078	.203	5/64	1/16	.070	.005	1,78	0,13	.070	.003	1,78	0,08
4005	.109	.234	3/32	1/16	.101	.005	2,57	0,13	.070	.003	1,78	0,08
4006	.125	.250	1/8	1/16	.114	.005	2,90	0,13	.070	.003	1,78	0,08
4007	.156	.281	5/32	1/16	.145	.005	3,68	0,13	.070	.003	1,78	0,08
4008	.187	.312	3/16	1/16	.176	.005	4,47	0,13	.070	.003	1,78	0,08
4009	.218	.343	7/32	1/16	.208	.005	5,28	0,13	.070	.003	1,78	0,08
4010	.250	.375	1/4	1/16	.239	.005	6,07	0,13	.070	.003	1,78	0,08
4011	.312	.437	5/16	1/16	.301	.005	7,65	0,13	.070	.003	1,78	0,08
4012	.375	.500	3/8	1/16	.364	.005	9,25	0,13	.070	.003	1,78	0,08
4013	.437	.562	7/16	1/16	.426	.005	10,82	0,13	.070	.003	1,78	0,08
4014	.500	.625	1/2	1/16	.489	.005	12,42	0,13	.070	.003	1,78	0,08
4015	.562	.687	9/16	1/16	.551	.007	14,00	0,18	.070	.003	1,78	0,08
4016	.625	.750	5/8	1/16	.614	.009	15,60	0,23	.070	.003	1,78	0,08
4017	.687	.812	11/16	1/16	.676	.009	17,17	0,23	.070	.003	1,78	0,08
4018	.750	.875	3/4	1/16	.739	.009	18,77	0,23	.070	.003	1,78	0,08
4019	.812	.937	13/16	1/16	.801	.009	20,35	0,23	.070	.003	1,78	0,08
4020	.875	1.000	7/8	1/16	.864	.009	21,95	0,23	.070	.003	1,78	0,08
4021	.937	1.062	15/16	1/16	.926	.009	23,52	0,23	.070	.003	1,78	0,08
4022	1.000	1.125	1	1/16	.989	.010	25,12	0,25	.070	.003	1,78	0,08
4023	1.062	1.187	1-1/16	1/16	1.051	.010	26,70	0,25	.070	.003	1,78	0,08
4024	1.125	1.250	1-1/8	1/16	1.114	.010	28,23	0,25	.070	.003	1,78	0,08
4025	1.187	1.312	1-3/16	1/16	1.176	.011	29,87	0,28	.070	.003	1,78	0,08
4026	1.250	1.375	1-1/4	1/16	1.239	.011	31,47	0,28	.070	.003	1,78	0,08
4027	1.312	1.437	1-5/16	1/16	1.301	.011	33,05	0,28	.070	.003	1,78	0,08
4028	1.375	1.500	1-3/8	1/16	1.364	.013	34,65	0,33	.070	.003	1,78	0,08
4029	1.500	1.625	1-1/2	1/16	1.489	.013	37,82	0,33	.070	.003	1,78	0,08
4030	1.625	1.750	1-5/8	1/16	1.614	.013	41,00	0,33	.070	.003	1,78	0,08
4031	1.750	1.875	1-3/4	1/16	1.739	.015	44,17	0,38	.070	.003	1,78	0,08
4032	1.875	2.000	1-7/8	1/16	1.864	.015	47,35	0,38	.070	.003	1,78	0,08
4033	2.000	2.125	2	1/16	1.989	.018	50,52	0,46	.070	.003	1,78	0,08
4034	2.125	2.250	2-1/8	1/16	2.114	.018	53,70	0,46	.070	.003	1,78	0,08
4035	2.250	2.375	2-1/4	1/16	2.239	.018	56,87	0,46	.070	.003	1,78	0,08
4036	2.375	2.500	2-3/8	1/16	2.364	.018	60,05	0,46	.070	.003	1,78	0,08
4037	2.500	2.625	2-1/2	1/16	2.489	.018	63,22	0,46	.070	.003	1,78	0,08
4038	2.625	2.750	2-5/8	1/16	2.614	.020	66,40	0,51	.070	.003	1,78	0,08
4039	2.750	2.875	2-3/4	1/16	2.739	.020	69,57	0,51	.070	.003	1,78	0,08
4040	2.875	3.000	2-7/8	1/16	2.864	.020	72,75	0,51	.070	.003	1,78	0,08
4041	3.000	3.125	3	1/16	2.989	.024	75,92	0,61	.070	.003	1,78	0,08
4042	3.250	3.375	3-1/4	1/16	3.239	.024	82,27	0,61	.070	.003	1,78	0,08
4043	3.500	3.625	3-1/2	1/16	3.489	.024	88,62	0,61	.070	.003	1,78	0,08
4044	3.750	3.875	3-3/4	1/16	3.739	.027	94,97	0,69	.070	.003	1,78	0,08
4045	4.000	4.125	4	1/16	3.989	.027	101,32	0,69	.070	.003	1,78	0,08
4046	4.250	4.375	4-1/4	1/16	4.239	.030	107,67	0,76	.070	.003	1,78	0,08
4047	4.500	4.625	4-3/4	1/16	4.489	.030	114,02	0,76	.070	.003	1,78	0,08
4048	4.750	4.875	4-3/4	1/16	4.739	.030	120,37	0,76	.070	.003	1,78	0,08
4049	5.000	5.125	5	1/16	4.989	.037	126,72	0,94	.070	.003	1,78	0,08
4050	5.250	5.375	5-1/4	1/16	5.239	.037	133,07	0,94	.070	.003	1,78	0,08

19. B. Precision Quad-Rings®/X-Rings Standard Sizes

Standard Quad-Ring® / X-Ring Sizes

Size Only Part nr.	Nominal Sizes				Actual Sizes							
	Rod	Bore	ID (in)	C/S (in)	ID (in)	+/-	ID(mm)	+/-	C/S (in)	+/-	C/S (mm)	+/-
4102	.062	.250	1/16	3/32	.049	.005	1,24	0,13	.103	.003	2,62	0,08
4103	.094	.281	3/32	3/32	.081	.005	2,06	0,13	.103	.003	2,62	0,08
4104	.125	.312	1/8	3/32	.112	.005	2,85	0,13	.103	.003	2,62	0,08
4105	.156	.343	5/32	3/32	.143	.005	3,63	0,13	.103	.003	2,62	0,08
4106	.187	.375	3/16	3/32	.174	.005	4,42	0,13	.103	.003	2,62	0,08
4107	.219	.406	7/32	3/32	.206	.005	5,23	0,13	.103	.003	2,62	0,08
4108	.250	.437	1/4	3/32	.237	.005	6,02	0,13	.103	.003	2,62	0,08
4109	.312	.500	5/16	3/32	.299	.005	7,60	0,13	.103	.003	2,62	0,08
4110	.375	.562	3/8	3/32	.362	.005	9,20	0,13	.103	.003	2,62	0,08
4111	.437	.625	7/16	3/32	.424	.005	10,77	0,13	.103	.003	2,62	0,08
4112	.500	.687	1/2	3/32	.487	.005	12,37	0,13	.103	.003	2,62	0,08
4113	.562	.750	9/16	3/32	.549	.007	13,95	0,18	.103	.003	2,62	0,08
4114	.625	.812	5/8	3/32	.612	.009	15,55	0,23	.103	.003	2,62	0,08
4115	.687	.875	11/16	3/32	.674	.009	17,12	0,23	.103	.003	2,62	0,08
4116	.750	.937	3/4	3/32	.737	.009	18,72	0,25	.103	.003	2,62	0,08
4117	.812	1.000	13/16	3/32	.799	.010	20,30	0,25	.103	.003	2,62	0,08
4118	.875	1.062	7/8	3/32	.862	.010	21,90	0,25	.103	.003	2,62	0,08
4119	.937	1.125	15/16	3/32	.924	.010	23,47	0,25	.103	.003	2,62	0,08
4120	1.000	1.187	1	3/32	.987	.010	25,07	0,25	.103	.003	2,62	0,08
4121	1.062	1.250	1-1/16	3/32	1.049	.010	26,65	0,25	.103	.003	2,62	0,08
4122	1.125	1.312	1-1/8	3/32	1.112	.010	28,25	0,25	.103	.003	2,62	0,08
4123	1.187	1.375	1-3/16	3/32	1.174	.012	29,82	0,31	.103	.003	2,62	0,08
4124	1.250	1.437	1-1/4	3/32	1.237	.012	31,42	0,31	.103	.003	2,62	0,08
4125	1.312	1.500	1-5/16	3/32	1.299	.012	33,00	0,31	.103	.003	2,62	0,08
4126	1.375	1.562	1-3/8	3/32	1.362	.012	34,60	0,31	.103	.003	2,62	0,08
4127	1.437	1.625	1-7/16	3/32	1.424	.012	36,17	0,31	.103	.003	2,62	0,08
4128	1.500	1.687	1-1/2	3/32	1.487	.012	37,77	0,31	.103	.003	2,62	0,08
4129	1.562	1.750	1-9/16	3/32	1.549	.015	39,35	0,38	.103	.003	2,62	0,08
4130	1.625	1.812	1-5/8	3/32	1.612	.015	41,00	0,38	.103	.003	2,62	0,08
4131	1.687	1.875	1-11/16	3/32	1.674	.015	42,52	0,38	.103	.003	2,62	0,08
4132	1.750	1.937	1-3/4	3/32	1.737	.015	44,12	0,38	.103	.003	2,62	0,08
4133	1.812	2.000	1-13/16	3/32	1.799	.015	45,70	0,38	.103	.003	2,62	0,08
4134	1.875	2.062	1-7/8	3/32	1.862	.015	47,30	0,38	.103	.003	2,62	0,08
4135	1.938	2.125	1-15/16	3/32	1.925	.017	48,90	0,43	.103	.003	2,62	0,08
4136	2.000	2.187	2	3/32	1.987	.017	50,47	0,43	.103	.003	2,62	0,08
4137	2.063	2.250	2-1/16	3/32	2.050	.017	52,07	0,43	.103	.003	2,62	0,08
4138	2.125	2.312	2-1/8	3/32	2.112	.017	53,65	0,43	.103	.003	2,62	0,08
4139	2.188	2.375	2-3/16	3/32	2.175	.017	55,25	0,43	.103	.003	2,62	0,08
4140	2.250	2.437	2-1/4	3/32	2.237	.017	56,82	0,43	.103	.003	2,62	0,08
4141	2.313	2.500	2-6/16	3/32	2.300	.020	58,42	0,51	.103	.003	2,62	0,08
4142	2.375	2.562	2-3/8	3/32	2.362	.020	60,00	0,51	.103	.003	2,62	0,08
4143	2.438	2.625	2-7/16	3/32	2.425	.020	61,60	0,51	.103	.003	2,62	0,08
4144	2.500	2.687	2-1/2	3/32	2.487	.020	63,17	0,51	.103	.003	2,62	0,08
4145	2.563	2.750	2-9/16	3/32	2.550	.020	64,77	0,51	.103	.003	2,62	0,08
4146	2.625	2.812	2-5/8	3/32	2.612	.020	66,34	0,51	.103	.003	2,62	0,08
4147	2.688	2.875	2-11/16	3/32	2.675	.022	67,95	0,56	.103	.003	2,62	0,08
4148	2.750	2.937	2-3/4	3/32	2.737	.022	69,52	0,56	.103	.003	2,62	0,08
4149	2.813	3.000	2-13/16	3/32	2.800	.022	71,12	0,56	.103	.003	2,62	0,08
4150	2.875	3.062	2-7/8	3/32	2.862	.022	72,70	0,56	.103	.003	2,62	0,08
4151	3.000	3.187	3	3/32	2.987	.024	75,87	0,61	.103	.003	2,62	0,08
4152	3.250	3.437	3-1/4	3/32	3.237	.024	82,22	0,61	.103	.003	2,62	0,08

19. B. Precision Quad-Rings®/X-Rings Standard Sizes

Standard Quad-Ring® / X-Ring Sizes

Size Only Part nr.	Nominal Sizes				Actual Sizes							
	Rod	Bore	ID (in)	C/S (in)	ID (in)	+/-	ID(mm)	+/-	C/S (in)	+/-	C/S (mm)	+/-
4153	3.500	3.687	3-1/2	3/32	3.487	.024	88,57	0,61	.103	.003	2,62	0,08
4154	3.750	3.937	3-3/4	3/32	3.737	.028	94,92	0,71	.103	.003	2,62	0,08
4155	4.000	4.187	4	3/32	3.987	.028	101,27	0,71	.103	.003	2,62	0,08
4156	4.250	4.437	4-1/4	3/32	4.237	.030	107,62	0,76	.103	.003	2,62	0,08
4157	4.500	4.687	4-1/2	3/32	4.487	.030	113,97	0,76	.103	.003	2,62	0,08
4158	4.750	4.937	4-3/4	3/32	4.737	.030	120,32	0,76	.103	.003	2,62	0,08
4159	5.000	5.187	5	3/32	4.987	.035	126,67	0,89	.103	.003	2,62	0,08
4160	5.250	5.437	5-1/4	3/32	5.237	.035	133,02	0,89	.103	.003	2,62	0,08
4161	5.500	5.687	5-1/2	3/32	5.487	.035	139,37	0,89	.103	.003	2,62	0,08
4162	5.750	5.937	5-3/4	3/32	5.737	.035	145,72	0,89	.103	.003	2,62	0,08
4163	6.000	6.187	6	3/32	5.987	.035	152,07	0,89	.103	.003	2,62	0,08
4164	6.250	6.437	6-1/4	3/32	6.237	.040	158,42	1,02	.103	.003	2,62	0,08
4165	6.500	6.687	6-1/2	3/32	6.487	.040	164,77	1,02	.103	.003	2,62	0,08
4166	6.750	6.937	6-3/4	3/32	6.737	.040	171,12	1,02	.103	.003	2,62	0,08
4167	7.000	7.187	7	3/32	6.987	.040	177,47	1,02	.103	.003	2,62	0,08
4168	7.250	7.437	7-1/4	3/32	7.237	.045	183,82	1,14	.103	.003	2,62	0,08
4169	7.500	7.687	7-1/2	3/32	7.487	.045	190,17	1,14	.103	.003	2,62	0,08
4170	7.750	7.937	7-3/4	3/32	7.737	.045	196,52	1,14	.103	.003	2,62	0,08
4171	8.000	8.187	8	3/32	7.987	.045	202,87	1,14	.103	.003	2,62	0,08
4172	8.250	8.437	8-1/4	3/32	8.237	.050	209,22	1,27	.103	.003	2,62	0,08
4173	8.500	8.687	8-1/2	3/32	8.487	.050	215,57	1,27	.103	.003	2,62	0,08
4174	8.750	8.937	8-3/4	3/32	8.737	.050	221,92	1,27	.103	.003	2,62	0,08
4175	9.000	9.187	9	3/32	8.987	.050	228,27	1,27	.103	.003	2,62	0,08
4176	9.250	9.437	9-1/4	3/32	9.237	.055	234,62	1,40	.103	.003	2,62	0,08
4177	9.500	9.687	9-1/2	3/32	9.487	.055	240,97	1,40	.103	.003	2,62	0,08
4178	9.750	9.937	9-3/4	3/32	9.737	.055	247,32	1,40	.103	.003	2,62	0,08
4201	.187	.437	3/16	1/8	.171	.005	4,34	0,13	.139	.004	3,53	0,10
4202	.250	.500	1/4	1/8	.234	.005	5,94	0,13	.139	.004	3,53	0,10
4203	.312	.562	5/16	1/8	.296	.005	7,52	0,13	.139	.004	3,53	0,10
4204	.375	.625	3/8	1/8	.359	.005	9,12	0,13	.139	.004	3,53	0,10
4205	.437	.687	7/16	1/8	.421	.005	10,69	0,13	.139	.004	3,53	0,10
4206	.500	.750	1/2	1/8	.484	.005	12,29	0,13	.139	.004	3,53	0,10
4207	.562	.812	9/16	1/8	.546	.007	13,87	0,18	.139	.004	3,53	0,10
4208	.625	.875	5/8	1/8	.609	.009	15,47	0,23	.139	.004	3,53	0,10
4209	.687	.937	11/16	1/8	.671	.009	17,04	0,23	.139	.004	3,53	0,10
4210	.750	1.000	3/4	1/8	.734	.010	18,64	0,25	.139	.004	3,53	0,10
4211	.812	1.062	13/16	1/8	.796	.010	20,22	0,25	.139	.004	3,53	0,10
4212	.875	1.125	7/8	1/8	.859	.010	21,82	0,25	.139	.004	3,53	0,10
4213	.937	1.187	15/16	1/8	.921	.010	23,39	0,25	.139	.004	3,53	0,10
4214	1.000	1.250	1	1/8	.984	.010	24,99	0,25	.139	.004	3,53	0,10
4215	1.062	1.312	1-1/16	1/8	1.046	.010	26,57	0,25	.139	.004	3,53	0,10
4216	1.125	1.375	1-1/8	1/8	1.109	.012	28,17	0,31	.139	.004	3,53	0,10
4217	1.187	1.437	1-3/16	1/8	1.171	.012	29,74	0,31	.139	.004	3,53	0,10
4218	1.250	1.500	1-1/4	1/8	1.234	.012	31,34	0,31	.139	.004	3,53	0,10
4219	1.312	1.562	1-5/16	1/8	1.296	.012	32,92	0,31	.139	.004	3,53	0,10
4220	1.375	1.625	1-3/8	1/8	1.359	.012	34,52	0,31	.139	.004	3,53	0,10
4221	1.437	1.687	1-7/16	1/8	1.421	.012	36,09	0,31	.139	.004	3,53	0,10
4222	1.500	1.750	1-1/2	1/8	1.484	.015	37,69	0,38	.139	.004	3,53	0,10
4223	1.625	1.875	1-5/8	1/8	1.609	.015	40,87	0,38	.139	.004	3,53	0,10
4224	1.750	2.000	1-3/4	1/8	1.734	.015	44,04	0,38	.139	.004	3,53	0,10

19. B. Precision Quad-Rings®/X-Rings Standard Sizes

Standard Quad-Ring® / X-Ring Sizes

Size Only		Nominal Sizes				Actual Sizes						
Part nr.	Rod	Bore	ID (in)	C/S (in)	ID (in)	+/-	ID(mm)	+/-	C/S (in)	+/-	C/S (mm)	+/-
4225	1.875	2.125	1-7/8	1/8	1.859	.018	47,22	0,46	.139	.004	3,53	0,10
4226	2.000	2.250	2	1/8	1.984	.018	50,39	0,46	.139	.004	3,53	0,10
4227	2.125	2.675	2-1/8	1/8	2.109	.018	53,57	0,46	.139	.004	3,53	0,10
4228	2.250	2.500	2-1/4	1/8	2.234	.020	56,74	0,51	.139	.004	3,53	0,10
4229	2.375	2.625	2-3/8	1/8	2.359	.020	59,92	0,51	.139	.004	3,53	0,10
4230	2.500	2.750	2-1/2	1/8	2.484	.020	63,09	0,51	.139	.004	3,53	0,10
4231	2.625	2.875	2-5/8	1/8	2.609	.020	66,27	0,51	.139	.004	3,53	0,10
4232	2.750	3.000	2-3/4	1/8	2.734	.024	69,44	0,61	.139	.004	3,53	0,10
4233	2.875	3.125	2-7/8	1/8	2.859	.024	72,62	0,61	.139	.004	3,53	0,10
4234	3.000	3.250	3	1/8	2.984	.024	75,79	0,61	.139	.004	3,53	0,10
4235	3.125	3.375	3-1/8	1/8	3.109	.024	78,97	0,61	.139	.004	3,53	0,10
4236	3.250	3.500	3-1/4	1/8	3.234	.024	82,14	0,61	.139	.004	3,53	0,10
4237	3.375	3.625	3-3/8	1/8	3.359	.024	85,32	0,61	.139	.004	3,53	0,10
4238	3.500	2.750	3-1/2	1/8	3.484	.024	88,49	0,61	.139	.004	3,53	0,10
4239	3.625	3.875	3-5/8	1/8	3.609	.028	91,67	0,71	.139	.004	3,53	0,10
4240	3.750	4.000	3-3/4	1/8	3.734	.028	94,84	0,71	.139	.004	3,53	0,10
4241	3.875	4.125	3-7/8	1/8	3.859	.028	98,02	0,71	.139	.004	3,53	0,10
4242	4.000	4.250	4	1/8	3.984	.028	101,19	0,71	.139	.004	3,53	0,10
4243	4.125	4.375	4-1/8	1/8	4.109	.028	104,37	0,71	.139	.004	3,53	0,10
4244	4.250	4.500	4-1/4	1/8	4.234	.030	107,54	0,76	.139	.004	3,53	0,10
4245	4.375	4.625	4-3/8	1/8	4.359	.030	110,72	0,76	.139	.004	3,53	0,10
4246	4.500	4.750	4-1/2	1/8	4.484	.030	113,89	0,76	.139	.004	3,53	0,10
4247	4.625	4.875	4-5/8	1/8	4.609	.030	117,07	0,76	.139	.004	3,53	0,10
4248	4.750	5.000	4-3/4	1/8	4.734	.030	120,24	0,76	.139	.004	3,53	0,10
4249	4.875	5.125	4-7/8	1/8	4.859	.035	123,42	0,89	.139	.004	3,53	0,10
4250	5.000	5.250	5	1/8	4.984	.035	126,59	0,89	.139	.004	3,53	0,10
4251	5.125	5.375	5-1/8	1/8	5.109	.035	129,77	0,89	.139	.004	3,53	0,10
4252	5.250	5.500	5-1/4	1/8	5.234	.035	132,94	0,89	.139	.004	3,53	0,10
4253	5.375	5.625	5-3/8	1/8	5.359	.035	136,12	0,89	.139	.004	3,53	0,10
4254	5.500	5.750	5-1/2	1/8	5.484	.035	139,29	0,89	.139	.004	3,53	0,10
4255	5.625	5.875	5-5/8	1/8	5.609	.035	142,47	0,89	.139	.004	3,53	0,10
4256	5.750	6.000	5-3/4	1/8	5.734	.035	145,64	0,89	.139	.004	3,53	0,10
4257	5.875	6.125	5-7/8	1/8	5.859	.035	148,82	0,89	.139	.004	3,53	0,10
4258	6.000	6.250	6	1/8	5.984	.035	151,99	0,89	.139	.004	3,53	0,10
4259	6.250	6.500	6-1/4	1/8	6.234	.040	158,34	1,02	.139	.004	3,53	0,10
4260	6.500	6.750	6-1/2	1/8	6.484	.040	164,69	1,02	.139	.004	3,53	0,10
4261	6.750	7.000	6-3/4	1/8	6.734	.040	171,04	1,02	.139	.004	3,53	0,10
4262	7.000	7.250	7	1/8	6.984	.040	177,39	1,02	.139	.004	3,53	0,10
4263	7.250	7.500	7-1/4	1/8	7.234	.045	183,74	1,14	.139	.004	3,53	0,10
4264	7.500	7.750	7-1/2	1/8	7.484	.045	190,10	1,14	.139	.004	3,53	0,10
4265	7.750	8.000	7-3/4	1/8	7.734	.045	196,44	1,14	.139	.004	3,53	0,10
4266	8.000	8.250	8	1/8	7.984	.045	202,79	1,14	.139	.004	3,53	0,10
4267	8.250	8.500	8-1/4	1/8	8.234	.050	209,14	1,27	.139	.004	3,53	0,10
4268	8.500	8.750	8-1/2	1/8	8.484	.050	215,49	1,27	.139	.004	3,53	0,10
4269	8.750	9.000	8-3/4	1/8	8.734	.050	221,84	1,27	.139	.004	3,53	0,10
4270	9.000	9.250	9	1/8	8.984	.050	228,19	1,27	.139	.004	3,53	0,10
4271	9.250	9.500	9-1/4	1/8	9.234	.055	234,54	1,40	.139	.004	3,53	0,10
4272	9.500	9.750	9-1/2	1/8	9.484	.055	240,89	1,40	.139	.004	3,53	0,10
4273	9.750	10.000	9-3/4	1/8	9.734	.055	247,24	1,40	.139	.004	3,53	0,10
4274	10.000	10.250	10	1/8	9.984	.055	253,59	1,40	.139	.004	3,53	0,10
4275	10.500	10.750	10-1/2	1/8	10.484	.055	266,29	1,40	.139	.004	3,53	0,10

**19. B. Precision Quad-Rings®/X-Rings Standard Sizes**

**Standard Quad-Ring® / X-Ring Sizes**

Size Only Part nr.	Nominal Sizes				Actual Sizes							
	Rod	Bore	ID (in)	C/S (in)	ID (in)	+/-	ID(mm)	+/-	C/S (in)	+/-	C/S (mm)	+/-
4276	11.000	11.250	11	1/8	10.984	.065	278,99	1,65	.139	.004	3,53	0,10
4277	11.500	11.750	11-1/2	1/8	11.484	.065	291,69	1,65	.139	.004	3,53	0,10
4278	12.000	12.250	12	1/8	11.984	.065	304,39	1,65	.139	.004	3,53	0,10
4279	13.000	13.250	13	1/8	12.984	.065	329,79	1,65	.139	.004	3,53	0,10
4280	14.000	14.250	14	1/8	13.984	.065	355,19	1,65	.139	.004	3,53	0,10
4281	15.000	15.250	15	1/8	14.984	.065	380,59	1,65	.139	.004	3,53	0,10
4282	16.000	16.250	16	1/8	15.955	.075	405,26	1,91	.139	.004	3,53	0,10
4283	17.000	17.250	17	1/8	16.955	.080	430,66	2,03	.139	.004	3,53	0,10
4284	18.000	18.250	18	1/8	17.955	.085	456,06	2,16	.139	.004	3,53	0,10
4309	.437	.812	7/16	3/16	.412	.005	10,47	0,13	.210	.005	5,33	0,13
4310	.500	.875	1/2	3/16	.475	.005	12,07	0,13	.210	.005	5,33	0,13
4311	.562	.937	9/16	3/16	.537	.007	13,64	0,18	.210	.005	5,33	0,13
4312	.625	1.000	5/8	3/16	.600	.009	15,24	0,23	.210	.005	5,33	0,13
4313	.687	1.062	11/16	3/16	.662	.009	16,82	0,23	.210	.005	5,33	0,13
4314	.750	1.125	3/4	3/16	.725	.010	18,42	0,25	.210	.005	5,33	0,13
4315	.812	1.187	13/16	3/16	.787	.010	19,99	0,25	.210	.005	5,33	0,13
4316	.875	1.250	7/8	3/16	.850	.010	21,59	0,25	.210	.005	5,33	0,13
4317	.937	1.312	15/16	3/16	.912	.010	23,17	0,25	.210	.005	5,33	0,13
4318	1.000	1.375	1	3/16	.975	.010	24,77	0,25	.210	.005	5,33	0,13
4319	1.062	1.437	1-1/16	3/16	1.037	.010	26,34	0,25	.210	.005	5,33	0,13
4320	1.125	1.500	1-1/8	3/16	1.100	.012	27,94	0,31	.210	.005	5,33	0,13
4321	1.187	1.562	1-3/16	3/16	1.162	.012	29,52	0,31	.210	.005	5,33	0,13
4322	1.250	1.625	1-1/4	3/16	1.225	.012	31,12	0,31	.210	.005	5,33	0,13
4323	1.312	1.687	1-5/16	3/16	1.287	.012	32,69	0,31	.210	.005	5,33	0,13
4324	1.375	1.750	1-3/8	3/16	1.350	.012	34,29	0,31	.210	.005	5,33	0,13
4325	1.500	1.875	1-1/2	3/16	1.475	.015	37,47	0,38	.210	.005	5,33	0,13
4326	1.625	2.000	1-5/8	3/16	1.600	.015	40,64	0,38	.210	.005	5,33	0,13
4327	1.750	2.125	1-3/4	3/16	1.725	.015	43,82	0,38	.210	.005	5,33	0,13
4328	1.875	2.250	1-7/8	3/16	1.850	.015	46,99	0,38	.210	.005	5,33	0,13
4329	2.000	2.375	2	3/16	1.975	.018	50,17	0,46	.210	.005	5,33	0,13
4330	2.125	2.500	2-1/8	3/16	2.100	.018	53,34	0,46	.210	.005	5,33	0,13
4331	2.250	2.625	2-1/4	3/16	2.225	.018	56,52	0,46	.210	.005	5,33	0,13
4332	2.375	2.750	2-3/8	3/16	2.350	.018	59,69	0,46	.210	.005	5,33	0,13
4333	2.500	2.875	2-1/2	3/16	2.475	.020	62,87	0,51	.210	.005	5,33	0,13
4334	2.625	3.000	2-5/8	3/16	2.600	.020	66,04	0,51	.210	.005	5,33	0,13
4335	2.750	3.125	2-3/4	3/16	2.725	.020	69,22	0,51	.210	.005	5,33	0,13
4336	2.875	3.250	2-7/8	3/16	2.850	.020	72,39	0,51	.210	.005	5,33	0,13
4337	3.000	3.375	3	3/16	2.975	.024	75,57	0,61	.210	.005	5,33	0,13
4338	3.125	3.500	3-1/8	3/16	3.100	.024	78,74	0,61	.210	.005	5,33	0,13
4339	3.250	3.625	3-1/4	3/16	3.225	.024	81,92	0,61	.210	.005	5,33	0,13
4340	3.375	3.750	3-3/8	3/16	3.350	.024	85,09	0,61	.210	.005	5,33	0,13
4341	3.500	3.875	3-1/2	3/16	3.475	.024	88,27	0,61	.210	.005	5,33	0,13
4342	3.625	4.000	3-5/8	3/16	3.600	.028	91,44	0,71	.210	.005	5,33	0,13
4343	3.750	4.125	3-3/4	3/16	3.725	.028	94,62	0,71	.210	.005	5,33	0,13
4344	3.875	4.250	3-7/8	3/16	3.850	.028	97,79	0,71	.210	.005	5,33	0,13
4345	4.000	4.375	4	3/16	3.975	.028	100,97	0,71	.210	.005	5,33	0,13
4346	4.125	4.500	4-1/8	3/16	4.100	.028	104,14	0,71	.210	.005	5,33	0,13
4347	4.250	4.625	4-1/4	3/16	4.225	.030	107,32	0,76	.210	.005	5,33	0,13
4348	4.375	4.750	4-3/8	3/16	4.350	.030	110,49	0,76	.210	.005	5,33	0,13
4349	4.500	4.875	4-1/2	3/16	4.475	.030	113,67	0,76	.210	.005	5,33	0,13



19. B. Precision Quad-Rings®/X-Rings Standard Sizes

Standard Quad-Ring® / X-Ring Sizes

Size Only Part nr.	Nominal Sizes				Actual Sizes							
	Rod	Bore	ID (in)	C/S (in)	ID (in)	+/-	ID(mm)	+/-	C/S (in)	+/-	C/S (mm)	+/-
4350	4.625	5.000	4-5/8	3/16	4.600	.030	116,84	0,76	.210	.005	5,33	0,13
4351	4.750	5.125	4-3/4	3/16	4.725	.030	120,02	0,76	.210	.005	5,33	0,13
4352	4.875	5.250	4-7/8	3/16	4.850	.030	123,19	0,76	.210	.005	5,33	0,13
4353	5.000	5.375	5	3/16	4.975	.037	126,37	0,94	.210	.005	5,33	0,13
4354	5.125	5.500	5-1/8	3/16	5.100	.037	129,54	0,94	.210	.005	5,33	0,13
4355	5.250	5.625	5-1/4	3/16	5.225	.037	132,72	0,94	.210	.005	5,33	0,13
4356	5.375	5.750	5-3/8	3/16	5.350	.037	135,89	0,94	.210	.005	5,33	0,13
4357	5.500	5.875	5-1/2	3/16	5.475	.037	139,07	0,94	.210	.005	5,33	0,13
4358	5.625	6.000	5-5/8	3/16	5.600	.037	142,24	0,94	.210	.005	5,33	0,13
4359	5.750	6.125	5-3/4	3/16	5.725	.037	145,42	0,94	.210	.005	5,33	0,13
4360	5.875	6.250	5-7/8	3/16	5.850	.037	148,59	0,94	.210	.005	5,33	0,13
4361	6.000	6.375	6	3/16	5.975	.037	151,77	0,94	.210	.005	5,33	0,13
4362	6.250	6.625	6-1/4	3/16	6.225	.040	158,12	1,02	.210	.005	5,33	0,13
4363	6.500	6.875	6-1/2	3/16	6.475	.040	164,47	1,02	.210	.005	5,33	0,13
4364	6.750	7.125	6-3/4	3/16	6.725	.040	170,82	1,02	.210	.005	5,33	0,13
4365	7.000	7.375	7	3/16	6.975	.040	177,17	1,02	.210	.005	5,33	0,13
4366	7.250	7.625	7-1/4	3/16	7.225	.045	183,52	1,14	.210	.005	5,33	0,13
4367	7.500	7.875	7-1/2	3/16	7.475	.045	189,87	1,14	.210	.005	5,33	0,13
4368	7.750	8.125	7-3/4	3/16	7.725	.045	196,22	1,14	.210	.005	5,33	0,13
4369	8.000	8.375	8	3/16	7.975	.045	202,57	1,14	.210	.005	5,33	0,13
4370	8.250	8.625	8-1/4	3/16	8.225	.050	208,92	1,27	.210	.005	5,33	0,13
4371	8.500	8.875	8-1/2	3/16	8.475	.050	215,27	1,27	.210	.005	5,33	0,13
4372	8.750	9.125	8-3/4	3/16	8.725	.050	221,62	1,27	.210	.005	5,33	0,13
4373	9.000	9.375	9	3/16	8.975	.050	227,97	1,27	.210	.005	5,33	0,13
4374	9.250	9.625	9-1/4	3/16	9.225	.055	234,32	0,14	.210	.005	5,33	0,13
4375	9.500	9.875	9-1/2	3/16	9.475	.055	240,67	0,14	.210	.005	5,33	0,13
4376	9.750	10.125	9-3/4	3/16	9.725	.055	247,02	0,14	.210	.005	5,33	0,13
4377	10.000	10.375	10	3/16	9.975	.055	253,37	0,14	.210	.005	5,33	0,13
4378	10.500	10.875	10-1/2	3/16	10.475	.060	266,07	1,52	.210	.005	5,33	0,13
4379	11.000	11.375	11	3/16	10.975	.060	278,77	1,52	.210	.005	5,33	0,13
4380	11.500	11.875	11-1/2	3/16	11.475	.065	291,47	1,65	.210	.005	5,33	0,13
4381	12.000	12.375	12	3/16	11.975	.065	304,17	1,65	.210	.005	5,33	0,13
4382	13.000	13.375	13	3/16	12.975	.065	329,57	1,65	.210	.005	5,33	0,13
4383	14.000	14.375	14	3/16	13.975	.070	354,97	1,78	.210	.005	5,33	0,13
4384	15.000	15.375	15	3/16	14.975	.070	380,37	1,78	.210	.005	5,33	0,13
4385	16.000	16.375	16	3/16	15.955	.075	405,26	1,91	.210	.005	5,33	0,13
4386	17.000	17.375	17	3/16	16.955	.080	430,66	2,03	.210	.005	5,33	0,13
4387	18.000	18.375	18	3/16	17.955	.085	456,06	2,16	.210	.005	5,33	0,13
4388	19.000	19.375	19	3/16	18.955	.090	481,41	2,29	.210	.005	5,33	0,13
4389	20.000	20.375	20	3/16	19.955	.095	506,81	2,41	.210	.005	5,33	0,13
4390	21.000	21.375	21	3/16	20.955	.095	532,21	2,41	.210	.005	5,33	0,13
4391	22.000	22.375	22	3/16	21.955	.100	557,61	2,54	.210	.005	5,33	0,13
4392	23.000	23.375	23	3/16	22.940	.105	582,68	2,67	.210	.005	5,33	0,13
4393	24.000	24.375	24	3/16	23.940	.110	608,08	2,79	.210	.005	5,33	0,13
4394	25.000	25.375	25	3/16	24.940	.115	633,48	2,92	.210	.005	5,33	0,13
4395	26.000	26.375	26	3/16	25.940	.120	658,88	3,05	.210	.005	5,33	0,13
4425	4.500	5.000	4-1/2	1/4	4.475	.033	113,67	0,84	.275	.006	6,99	0,15
4426	4.625	5.125	4-5/8	1/4	4.600	.033	116,84	0,84	.275	.006	6,99	0,15
4427	4.750	5.250	4-3/4	1/4	4.725	.033	120,02	0,84	.275	.006	6,99	0,15
4428	4.875	5.375	4-7/8	1/4	4.850	.033	123,19	0,84	.275	.006	6,99	0,15

**19. B. Precision Quad-Rings®/X-Rings Standard Sizes**

**Standard Quad-Ring® / X-Ring Sizes**

Size Only Part nr.	Nominal Sizes		Actual Sizes									
	Rod	Bore	ID (in)	C/S (in)	ID (in)	+/-	ID(mm)	+/-	C/S (in)	+/-	C/S (mm)	+/-
4429	5.000	5.500	5	1/4	4.975	.037	126,37	0,94	.275	.006	6,99	0,15
4430	5.125	5.625	5-1/8	1/4	5.100	.037	129,54	0,94	.275	.006	6,99	0,15
4431	5.250	5.750	5-1/4	1/4	5.225	.037	132,72	0,94	.275	.006	6,99	0,15
4432	5.375	5.875	5-3/8	1/4	5.350	.037	135,89	0,94	.275	.006	6,99	0,15
4433	5.500	6.000	5-1/2	1/4	5.475	.037	139,07	0,94	.275	.006	6,99	0,15
4434	5.625	6.125	5-5/8	1/4	5.600	.037	142,24	0,94	.275	.006	6,99	0,15
4435	5.750	6.250	5-3/4	1/4	5.725	.037	145,42	0,94	.275	.006	6,99	0,15
4436	5.875	6.375	5-7/8	1/4	5.850	.037	148,59	0,94	.275	.006	6,99	0,15
4437	6.000	6.500	6	1/4	5.975	.037	151,77	0,94	.275	.006	6,99	0,15
4438	6.250	6.750	6-1/4	1/4	6.225	.040	158,12	1,02	.275	.006	6,99	0,15
4439	6.500	7.000	6-1/2	1/4	6.475	.040	164,47	1,02	.275	.006	6,99	0,15
4440	6.750	7.250	6-3/4	1/4	6.725	.040	170,82	1,02	.275	.006	6,99	0,15
4441	7.000	7.500	7	1/4	6.975	.040	177,17	1,02	.275	.006	6,99	0,15
4442	7.250	7.750	7-1/4	1/4	7.225	.045	183,52	1,14	.275	.006	6,99	0,15
4443	7.500	8.000	7-1/2	1/4	7.475	.045	189,87	1,14	.275	.006	6,99	0,15
4444	7.750	8.250	7-3/4	1/4	7.725	.045	196,22	1,14	.275	.006	6,99	0,15
4445	8.000	8.500	8	1/4	7.975	.045	202,57	1,14	.275	.006	6,99	0,15
4446	8.500	9.000	8-1/2	1/4	8.475	.055	215,27	1,40	.275	.006	6,99	0,15
4447	9.000	9.500	9	1/4	8.975	.055	227,97	1,40	.275	.006	6,99	0,15
4448	9.500	10.000	9-1/2	1/4	9.475	.055	240,67	1,40	.275	.006	6,99	0,15
4449	10.000	10.500	10	1/4	9.975	.055	253,37	1,40	.275	.006	6,99	0,15
4450	10.500	11.000	10-1/2	1/4	10.475	.060	266,07	1,52	.275	.006	6,99	0,15
4451	11.000	11.500	11	1/4	10.975	.060	278,77	1,52	.275	.006	6,99	0,15
4452	11.500	12.000	11-1/2	1/4	11.475	.065	291,47	1,52	.275	.006	6,99	0,15
4453	12.000	12.500	12	1/4	11.975	.065	304,17	1,52	.275	.006	6,99	0,15
4454	12.500	13.000	12-1/2	1/4	12.475	.065	316,87	1,52	.275	.006	6,99	0,15
4455	13.000	13.500	13	1/4	12.975	.065	329,57	1,52	.275	.006	6,99	0,15
4456	13.500	14.000	13-1/2	1/4	13.475	.070	342,27	1,78	.275	.006	6,99	0,15
4457	14.000	14.500	14	1/4	13.975	.070	354,97	1,78	.275	.006	6,99	0,15
4458	14.500	15.000	14-1/2	1/4	14.475	.070	367,67	1,78	.275	.006	6,99	0,15
4459	15.000	15.500	15	1/4	14.975	.070	380,37	1,78	.275	.006	6,99	0,15
4460	15.500	16.000	15-1/2	1/4	15.475	.070	393,07	1,78	.275	.006	6,99	0,15
4461	16.000	16.500	16	1/4	15.955	.075	405,26	1,91	.275	.006	6,99	0,15
4462	16.500	17.000	16-1/2	1/4	16.455	.075	417,96	1,91	.275	.006	6,99	0,15
4463	17.000	17.500	17	1/4	16.955	.080	430,66	2,03	.275	.006	6,99	0,15
4464	17.500	18.000	17-1/2	1/4	17.455	.085	443,36	2,16	.275	.006	6,99	0,15
4465	18.000	18.500	18	1/4	17.955	.085	456,06	2,16	.275	.006	6,99	0,15
4466	18.500	19.000	18-1/2	1/4	18.455	.085	468,76	2,16	.275	.006	6,99	0,15
4467	19.000	19.500	19	1/4	18.955	.090	481,46	2,29	.275	.006	6,99	0,15
4468	19.500	20.000	19-1/2	1/4	19.455	.090	494,16	2,29	.275	.006	6,99	0,15
4469	20.000	20.500	20	1/4	19.955	.095	506,86	2,41	.275	.006	6,99	0,15
4470	21.000	21.500	21	1/4	20.955	.095	532,26	2,41	.275	.006	6,99	0,15
4471	22.000	22.500	22	1/4	21.955	.100	557,66	2,54	.275	.006	6,99	0,15
4472	23.000	23.500	23	1/4	22.940	.105	582,68	2,67	.275	.006	6,99	0,15
4473	24.000	24.500	24	1/4	23.940	.110	608,08	2,79	.275	.006	6,99	0,15
4474	25.000	25.500	25	1/4	24.940	.115	633,48	2,92	.275	.006	6,99	0,15
4475	26.000	26.500	26	1/4	25.940	.120	658,88	3,05	.275	.006	6,99	0,15

### 19. C. Gland design for Rotating Quad-Rings®/X-Rings Applications

As already mentioned, the rotating speed of  $> 100$  feet/mn (30m/ min.) is critical. It is recommended to use radial lip seals like oil and grease shaft seals or PS-seals. However the compact installation of Quad-Rings®/X-Rings with the roto principle can be used instead. It is expected that the shaft rotates in the stationary Quad-Ring®/ X-Rings.

#### The next points need to be taken into consideration:

- The Gow-Joule effect. The Quad-Ring®/X-Ring should not be installed in a stretched position around the shaft. The inner diameter of the Quad-Ring®/X-Ring needs to be 2-5% larger than the diameter of the shaft.
- Do not install the Quad-Ring®/X-Ring in a groove in the shaft. It can happen that the Quad-Ring®/X-Ring will rotate with the shaft.
- Avoid applications with temperatures lower than  $-30^{\circ}\text{C}$  or higher than  $+100^{\circ}\text{C}$  ( $-22^{\circ}\text{F}$  or higher than  $+212^{\circ}\text{F}$ ).
- Rotation speeds need to be limited to 6.5 ft/s (2m/sec.) and pressures to 150 psi (10 bar ,1 MPa).
- For higher pressures, up to 450 psi (30 bar, 3MPa) back-up rings must be used.
- Up to a diameter of 4 inches (100 mm), the cross section of the Quad-Ring®/X-Ring needs to be limited on sizes .103 to .210 inch (2,62 to 5,33 mm). For larger shaft diameters  $>4$  inches ( $>100$  mm) , the cross section of the Quad-Ring®/X-Ring has to be at least .275 inch (6,99 mm).
- The surface finish of the groove always has to be rougher than the surface finish of the shaft to avoid spinning.
- Lubrication of the Quad-Ring®/X-Ring reduces the frictional force, keeps the seal cool, and reduces the tendency of the seal to harden.
- It is very important that the shaft construction have good bearings.
- For rotating application always use Quad-Rings®/X-Rings in 80 or 90 Shore A.

#### Surface Finish: X

Groove top and bottom X= 16 micro inches (0,4  $\mu\text{m}$  Ra)

Groove sides X= 32 micro inches (0,8  $\mu\text{m}$  Ra)

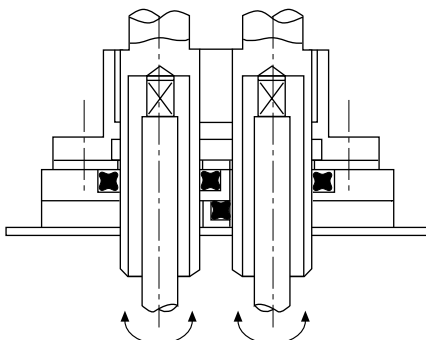

Ask for the ERIKS  
information on  
rotating  
Quad-Ring®/X-Ring  
applications!

### 20. Troubleshooting

#### O-ring Failure

The failure of an O-ring in service can usually be attributed to a combination of causes. It is important therefore, to maximize seal life and reliability by the use of good design practices, proper compound selection, pre-product testing, and continued education and training of personnel.

The following brief summary of O-ring failure patterns is intended to give the engineer a brief overview of the more common types of failure and a listing of recommended corrective actions. Listed are the most common causes of seal failure.

For a complete listing of O-ring failure modes obtain a copy of AIR1707 Patterns of O-ring Failure available from SAE INC.

#### Extrusion and Nibbling

**Failure Pattern:** Typical of high pressure systems, this pattern can be identified by the many small bites (nibbles) taken from the O-ring on the downstream (low pressure) side.

**Problem Source:** excessive clearances; excessive system pressures; O-ring material too soft; degradation of the O-ring by system fluid; irregular clearance gaps caused by eccentricity; improper machining; sharp edges; or the O-ring size is too large for the gland.

**Suggested solution:** decrease gland clearances by machining; use back-up rings to prevent extrusion; employ harder O-rings; re-check elastomer compatibility; improve concentricity; break sharp edges; or install proper size O-ring.

#### Spiral Failure

**Failure pattern:** generally found on long stroke hydraulic piston seals with low pressure differential. The surface of the O-ring exhibits a series of deep, spiral, 45° angle cuts.

**Problem source:** caused when certain segments of the O-ring slide while other segments simultaneously roll. At a single point on its periphery, the O-ring gets caught on an eccentric component, or against the cylinder wall, causing twisting and development of 45° angle, surface cuts.

**Suggested solution:** check for out of round cylinder bore; decrease clearance gap; machine metal surfaces to 10-20 micro-inch finish; improve lubrication; use internally-lubricated O-rings; employ back-up rings; employ Quad-Rings®/X-Rings; or in severe cases use a T-seal.

#### Abrasion

**Failure pattern:** Occuring primarily in dynamic seals involving reciprocating, oscillating, or rotary motion. This failure pattern can be identified by a flattened surface on one side of the O-ring's cross section or wearlines on the cross section parallel to motion.

**Problem Source:** Metal surfaces too rough (acting as an abrasive); metal surfaces too smooth, causing inadequate lubrication; poor lubrication; excessive temperatures; or the system is contaminated with abrasives.

**Suggested solution:** use recommended metal finishes; provide adequate lubrication; check material compatibility with system temperature; or eliminate abrasive contamination with filters.

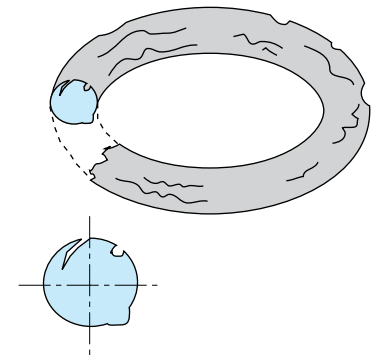

Picture of an extruded, nibbled O-ring

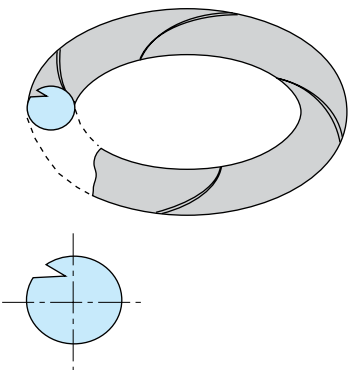

Picture of a spiral failure O-ring

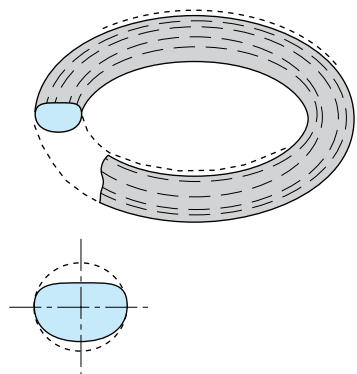

Picture of an abrasion affected O-ring

### 20. Troubleshooting

#### Compression Set

**Failure Pattern:** common to both static and dynamic seals, compression set failure produces flat surfaces on both sides of the O-ring cross section in the area being squeezed.

**Problem Source:** selection of an elastomer with poor compression set properties; system pressure is too high; excessive swelling of O-ring material in system fluid; too much squeeze to achieve seal; incomplete curing of O-ring material during vulcanisation; or excessive system temperature.

**Suggested Solutions:** employ a low compression set elastomer; specify an O-ring material that resists operating or frictionally generated heat; re-check O-ring compatibility with system chemicals; reduce O-ring squeeze if possible; or inspect incoming O-rings for correct physical dimensions.

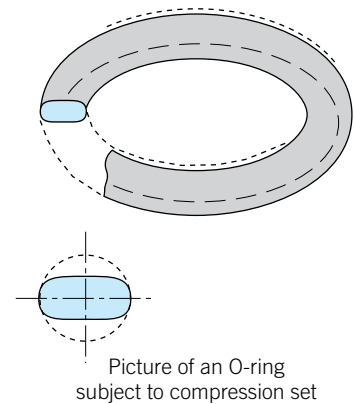

#### Weather or Ozone Cracking

**Failure Pattern:** occurring in both static and dynamic seals exposed to atmospheres containing ozone and other air pollutants. This failure mode is marked by the appearance of many small surface cracks perpendicular to the direction of stress.

**Problem Source:** ozone attacks unsaturated or double bond points in some polymer chains, causing chain scission. Cracking of the outside surface of the O-ring is the result.

**Suggested Solution:** employ O-ring elastomers that are resistant to ozone attack.

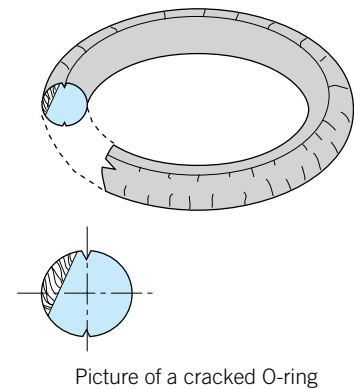

#### Heat Hardening and Oxidation

**Failure Pattern:** seen in both static and dynamic seals, in pneumatic or air service. The surface of the O-ring appears pitted and/or cracked, often accompanied by the flatness of high compression set.

**Problem Source:** excessive environmental temperature causing excessive elastomer hardening, evaporation of plasticizer, and cracking from oxidation.

**Suggested Solution:** lower operating temperature or specify high temperature and oxidation resistant O-ring materials.

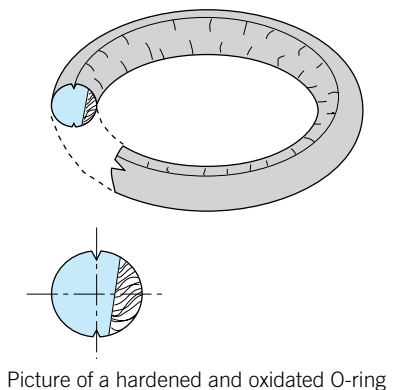

#### Plasticizer Extraction

**Failure Pattern:** occurring in both static and dynamic seals, primarily in fuel system service. This failure pattern is marked by small cracks in the O-ring stress area, accompanied by a loss of physical volume.

**Problem Source:** extraction of O-ring material plasticizer component by system chemicals or fluids in a dry-out situation.

**Suggested Solution:** employ chemically compatible O-ring material with low-to-no extractable plasticizer content.

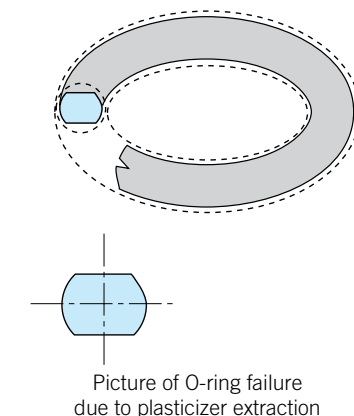

### 20. Troubleshooting

#### Installation Damage

**Failure Pattern:** occurring in both static and dynamic seals. This failure mode is marked by short cuts, notches, or a skinned or peripherally peeled surface on the O-ring.

**Problem Source:** sharp edges on mating metal components of the O-ring gland; sharp threads over which the O-ring must pass during assembly; insufficient lead-in chamfer; blind grooves in multi-port valves; oversize O-ring I.D. on piston; undersize O-ring I.D. on rod; twisting or pinching of the O-ring during installation; or no O-ring lubrication during installation.

**Suggested Solution:** break sharp edges on mating metal components; cover threads with tubes or tape during O-ring installation; provide a 20° lead-in chamfer; break sharp corners of chamfer and O-ring groove edges; install correctly sized O-rings; and use lubrication during assembly.

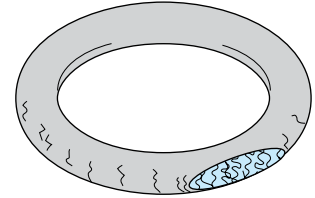

Picture of a damaged O-ring

#### Explosive Decompression

**Failure Pattern:** marked by random short splits or ruptures going deep into the O-ring cross section. When the O-ring is first removed, the surface may also be covered with small blisters.

**Problem Source:** absorption of gas by the O-ring while operating in high pressure conditions. Subsequent rapid decrease in system pressure traps within the O-ring micropores, causing surface blisters and ruptures as the gas seeks an avenue of escape.

**Suggested Solution:** increase time for decompression; increase material hardness to 80°-95° shore A; reduce O-ring cross sectional size; or specify a decompression resistant material, such as a harder nitrile or special Viton® 514162.

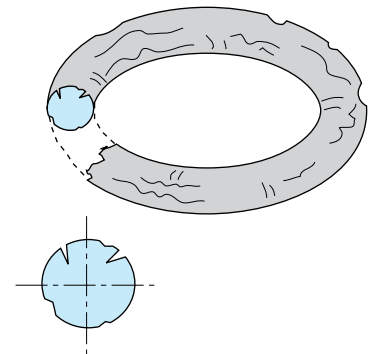

Picture of an exploded O-ring

#### Back-up ring Failure

**Failure Pattern:** occurring exclusively in dynamic seals, the O-ring surface is notched or nibbled adjacent to the scarf cut or overlap of the back-up ring.

**Problem source:** thermal changes, pressure surges, and extrusion of the back-up ring into the gap.

**Suggested Solution:** check design details and consider the solid type of back-up ring. Use PEEK (plastic) or another material.

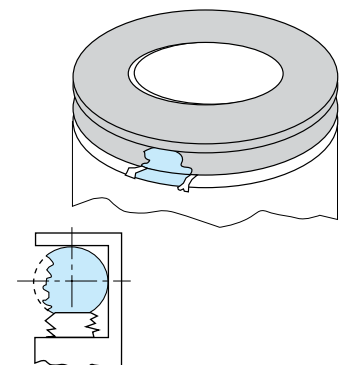

Picture of a damaged back-up and O-ring

## 21. Glossary

### Abrasion

Progressive wearing away of material by mechanical action.

### Abrasion Resistance

The ability of a rubber compound to resist mechanical wear.

### Absorption

The physical mechanism by which one substance attracts and takes up another substance.

### Accelerated Life Test

Any set of conditions designed to reproduce in a short time the deteriorating effect obtained under normal service conditions.

### Accelerated Service Test

A service or bench test in which some service condition, such as speed, temperature, or continuity of operation, is exaggerated in order to obtain a result in shorter time.

### Accelerator

A substance which hastens the vulcanization of an elastomer causing it to take place in a shorter time or at a lower temperature.

### Acid Resistant

Withstands the action of acids.

### Adhere

To cling or stick together.

### Adhesion

Susceptibility of rubber to stick to a contact surface.

### Aflas

Trade name of Asahi Glass for TFE Propylene.

### After Cure

Continuation of vulcanization after the desired cure is effected and the heat source removed.

### Aging

To undergo changes in physical properties with age or lapse of time.

### Aging, Air Oven

A means of accelerating the change in physical properties of rubber compounds by exposing them to the action of air at an elevated temperature.

### Aging, Air Pressure Heat

A means of accelerating the change in physical properties of rubber compounds by exposing them to the action of air under pressure at an elevated temperature.

### Aging, Oxygen Bomb

A means of accelerating the change in physical properties of rubber compounds by exposing them to the action of oxygen at an elevated temperature and pressure.

### Air Bomb

Similar to an oxygen bomb but used with air. Used for accelerated aging test.

### Air Checks

Surface marking or depressions due to trapping air between the materials being cured and the mold or press surface.

### Air Curing

The vulcanization of a rubber product in air as distinguished from vulcanizing in a press or steam vulcanizer.

### Ambient Temperature

The environment temperature surrounding the object under consideration.

### Aniline Point of Oil

The lowest temperature at which equal volumes of pure aniline and a particular oil will completely dissolve in one another. The aniline point generally affects the swell.

### Antioxidant

An organic substance which inhibits or retards oxidation.

### Atmospheric Cracking

Cracks produced in surface of rubber articles by exposure to atmospheric conditions.

### Average Modulus

Total change of stress divided by total change of strain, i.e., the average slope of the stress-strain curve. Employed when modulus varies from point to point.

### 21. Glossary

#### Back Rind

A burn-back into the part at a mold line separation caused by too soft a rubber stock, excessive acceleration, or too low a plasticity.

#### Back-up ring

Washer-like device installed next to O-ring to prevent extrusion.

#### Bench Test

A modified service test in which the service conditions are approximated, but the equipment is conventional laboratory equipment and not necessarily identical with that in which the product will be employed.

#### Bending Modulus

Force required to induce bending around a given radius, and hence a measure of stiffness.

#### Bleeding

Migration to the surface of plasticizers, waxes, or similar materials to form a film or beads.

#### Blemish

A mark, deformity, or injury which impairs the appearance.

#### Blisters

A raised spot on the surface or a separation between layers usually forming a void or air-filled space in the vulcanized article.

#### Bloom

A discoloration or change in appearance of the surface of a rubber product caused by the migration of a liquid or solid to the surface. Examples: sulfur broom, wax broom. Not to be confused with dust on the surface from external sources.

#### Break

A separation or discontinuity in any part of an article.

#### Breakout

Force to inaugurate sliding. Expressed in same terms as friction. An excessive breakout value is taken as an indication of the development of adhesion.

#### Brittleness

Tendency to crack when subjected to deformation.

#### Buna N

A general term for the copolymers of butadiene and acrylonitrile. Typical commercial polymers are Hycar and Paracril.

#### Buna S

A general term for the copolymers of butadiene and styrene.

#### Butt Joint

Joining two ends of material whereby the junction is perpendicular to the plane of an O-ring.

#### Butyl

A synthetic rubber of the polybutene type exhibiting very low permeability to gases.

#### Coefficient of Thermal Expansion

Average expansion per degree over a stated temperature range, expressed in a fraction of initial dimension. May be linear or volumetric.

#### Cold Flexibility

Flexibility following exposure to a predetermined low temperature for a predetermined time.

#### Cold Flow

Continued deformation under stress.

#### Cold Resistant

Withstands the effect of cold or low temperatures without loss of serviceability.

#### Commercially Smooth

Degree of smoothness of the surface of an article which is acceptable for use.

#### Compound

A term applied to either vulcanized or unvulcanized mixtures of elastomers and other ingredients necessary to make a useful rubber-like material.

#### Compression Modulus

The ratio of the compressive stress to the resulting compressive strain (the latter expressed as a fraction of the original height or thickness in the direction of the force). Compression Modulus may be either static or dynamic.

#### Compression Set

The decrease in thickness of a rubber specimen which has been deformed under specific conditions of load, time, and temperature. It is usually expressed as a percentage of the initial compression of the test sample.



### 21. Glossary

#### Conductive rubber

A rubber having qualities of conduction or transmitting heat or electricity. Most generally applied to rubber products used to conduct static electricity.

#### Conductivity

Quality or power of conducting or transmitting heat or electricity.

#### Copolymer

A polymer consisting of two different monomers chemically combined.

#### Corrosion (Packing)

Corrosion of rigid member (usually metal) where it contacts packing. The actual corroding agent is fluid medium trapped in the interface.

#### Corrosive (Packing)

A property of packing whereby it is assumed, often incorrectly, to promote corrosion of the rigid member by the trapped fluid.

#### Cracking

A sharp break or fissure in the surface. Generally due to excessive strain.

#### Creep

The relaxation of a rubber material while under stress.

#### Cross section

An O-ring viewed as it were if cut at right angles to the axis showing internal structure.

#### Curing Date

O-ring molding date.

#### Curing Temperature

The temperature at which the rubber product is vulcanized.

#### Cylinder

Chamber in which piston, plunger, ram, rod, or shaft is driven by or against the pressure medium.

#### Degassing

The intentional but controlled outgassing of a rubber substance.

#### Durometer

An instrument for measuring the hardness of rubber. Measures the resistance to the penetration of an indenter point into the surface of rubber.

#### Dynamic

O-ring application in which the O-ring is subject to movement or moving parts.

#### Dynamic Packing

A packing employed in a joint whose members are in relative motion.

#### Dynamic Seal

A seal required to prevent leakage past parts which are in relative motion.

#### Elasticity

The property of an article which tends to return to its original shape after deformation.

#### Elastic Limit

The greatest stress which a material is capable of developing without a permanent deformation remaining upon complete release of the stress. In rubber, the elastic limit as above defined is very low and sometimes practically non-existent. Usually this term is replaced by various load limits for specific cases in which the resulting permanent deformations are not zero but are negligible.

#### Elastomer

A general term for an elastic, rubber-like substance. A polymeric material which may be compressed or otherwise deformed, and by virtue of its molecular structure, will recover almost completely to its original form.

#### EMI Gasket

A component, usually incorporating a formed resilient elastomer, which will allow a seam or enclosure panel interface to be reliably interconnected (electrical bonded) along the entire joint.

#### Elongation

Increase in length expressed numerically as a fraction or percentage of initial length.

#### Ethylene Propylene

Elastomer prepared from ethylene and propylene monomers.

### 21. Glossary

#### Explosive Decompression

Expanding of gas (or volatile liquid) in case of a sudden pressure drop.

#### Extrusion

Distortion, under pressure, of portion of seal into clearance between mating metal parts.

#### Fam

Test fluid for extraction of softeners out of the rubber compound.

#### Filler

Chemically inert, finely divided material added to the polymer to aid in processing and improving properties of abrasion resistance and strength - gives it varying degrees of hardness.

#### Flash

Excess rubber left around rubber part after molding due to space between mating mold surfaces; removed by trimming.

#### Flex Cracking

A surface cracking induced by repeated bending or flexing.

#### Flex Life

The relative ability of a rubber article to withstand dynamic bending stresses.

#### Flock

Fibers added to rubber compounds.

#### Flow Cracks

Surface imperfections due to improper flow and failure of stock to knit or blend with itself during the molding operation.

#### Fluorocarbon, Perfluorocarbon

Highly fluorinated carbon backboned polymers.

#### Friction

Resistance to motion due to the contact of surfaces.

#### Friction, Breakout

Initial or starting friction developed of a dynamic seal.

#### Friction, Running

Friction developed during operation of a dynamic seal.

#### Fuel, Aromatic

Fuel which contains benzene or aromatic hydrocarbons.

#### Fuel, Non-Aromatic

Fuel which is composed of straight chain hydrocarbons.

#### Gland

Seal assembly, including the O-ring; groove which holds the O-ring and the contacting surfaces.

#### Gow-Joule effect

Elastomers under stretch give higher tension when the temperatures rises.

#### Hardness

Property or extent of being hard. Measured in degrees and based on the penetration into the rubber of a defined indenter under a set load.

#### Hardness Shore A

Durometer reading in degrees of the hardness of the rubber based on a shore durometer.

#### Homogeneous

General - a material of uniform composition throughout.

#### Hycar

Commercial name of B.F. Goodrich for polyacrylate rubber, ACM polymer of acrylic acid ester.

#### Hypalon

Commercial name for a chlorosulphonated derivative of polyethylene.

### 21. Glossary

#### Immediate Set

The deformation found by measurement immediately after removal of the load causing the deformation.

#### Immersion

Placing an article into a fluid, generally so it is completely covered.

#### Impact

The single instantaneous stroke or contact of a moving body with another either moving or at rest, such as a large lump of material dropping on a conveyor belt.

#### Internal Lubrication

The incorporation of friction reducing ingredients (graphite, molybdenum disulfide, powdered Teflon®, or organic lubricants) in the rubber compound.

#### Labsfree

The absence of any trace of ingredient on the surface of the O-ring which can cause adhesion problems (i.a. paint industry).

#### Leakage Rate

The rate at which either a gas or liquid passes a barrier.

#### Life Test

A laboratory procedure used to determine the amount and duration of resistance of a rubber article to a specific set of destructive forces or conditions.

#### Linear Expansion

Expansion in any one linear dimension or the average of all linear dimensions.

#### Logy

Sluggish, low snap or recovery of a material.

#### Low Temperature Flexibility

The ability of a rubber product to be flexed, bent or bowed at low temperatures.

#### Low Temperature Flexing

Act or instance of repeated bending or bowing a rubber product under conditions of low temperature.

#### Media

A liquid, a gas, or a mixture of both.

#### Memory

Tendency of a material to return to original shape after deformation.

#### Micro O-rings

Any O-ring that measures less than .4 inch (1 mm) in either inside diameter or cross section.

#### Mirror Finish

A bright, polished surface.

#### Misalignment

Departure from alignment.

#### Mismatch

Poor matching or meeting in splice.

#### Modulus

Tensile stress at a specified elongation (generally 100%).

#### Modulus of Elasticity

One of the several measurements of stiffness or resistance to deformation, but often incorrectly used to indicate specifically static tension modulus.

#### Mold Cavity

Hollow space or cavity in the mold which is used to impart the desired form to the product being molded.

#### Mold Finish

The uninterrupted surface produced by intimate contact of rubber with the surface of the mold at vulcanization.

#### Mold Lubricant

A material usually sprayed onto the mold cavity surface, to facilitate the easy removal of the molded rubber parts.

#### Mold Marks

Indentations or ridges embossed into the skin of the molded product by irregularities in the mold cavity surface.

### 21. Glossary

#### Mold Register

Means used to align the parts of a mold.

#### Mooney Scorch

The measurement of the rate at which a rubber compound will precure or set up by means of the Mooney Viscometer.

#### Mooney Viscosity

The measurement of the plasticity or viscosity of a not compounded or compounded but not vulcanized rubber and rubber-like material by means of the Mooney Shearing Disk Viscometer.

#### Natural Rubber

Raw or crude rubber obtained from vegetable sources, basically the unsaturated polymer of isoprene.

#### Neoprene

Homopolymers of chloroprene. DuPont's name for chloroprene rubber.

#### Nick

A small notch, slit, or cut.

#### Nitrile (Buna N)

Copolymer of butadiene and acrylonitrile; known commercially as Butaprene, Chemigum, Hycar OR, Perbunan and Paracril. (See Buna N)

#### Nominal Length

The desired length from which tolerances are set.

#### Non-Blooming

The absence of bloom.

#### Off-Register

Misalignment of mold halves causing an out-of-round O-ring cross section.

#### Oil Resistant

Ability of a vulcanized rubber to resist the swelling and deteriorating effects of various type oils.

#### Oil Swell

The change in volume of a rubber article due to absorption of oil.

#### O-ring

An elastomeric seal of homogeneous composition molded in one piece to the configuration of a torus with circular cross section (doughnut). The O-ring is used as a dynamic or static seal usually installed in a machined groove.

#### Optimum Cure

State of vulcanization at which maximum desired property is attained.

#### Over Cure

A degree of cure greater than the optimum.

#### Outgassing

A vacuum phenomenon where a substance spontaneously releases volatile constituents in the form of vapors or gases.

#### Oxidation

The reaction of oxygen on a rubber product, usually detected by a change in the appearance or feel of the surface or by a change in physical properties.

#### Oxygen Bomb

A chamber capable of holding oxygen at an elevated pressure which can be heated to an elevated temperature. Used for an accelerated aging test (See Aging).

#### Ozone Resistant

Withstands the deteriorating effects of ozone (generally cracking).

#### Packing

A flexible device used to retain fluids under pressure or seal out foreign matter.

#### Packing Groove

A groove carved in a flange, or in one member of a concentric joint, to accommodate a packing.

#### Perbunan

Standard Oil of New Jersey's name for chloroprene rubber.

### 21. Glossary

#### Permanent Set

Permanent set is the deformation remaining after a specimen has been stressed in tension a prescribed amount of time and released for a definite period.

#### Pit or Pock Mark

A circular depression, usually small.

#### Plasticizer

A substance, usually a liquid, added to an elastomer to decrease stiffness, improve low temperature properties, and improve processing.

#### Polymer

A material formed by the joining together of many (poly) individual units (mer) of a monomer.

#### Porosity

Quality of state of being porous due to presence of globular structural voids.

#### Post Cure

The second step in the vulcanization process for some elastomers. Provides stabilization of parts and drives off decomposition products resulting from the vulcanization process.

#### Radiation

Emission of alpha particles, beta particles, or electromagnetic energy (gamma radiation).

#### Register, Off or Uneven

Nonconformity of finished article with design dimensions due to mold misalignment during cure.

#### Relative Humidity

The ratio of the quantity of water vapor actually present in the atmosphere to the greatest amount possible at the given temperature.

#### Resilience

Capable of returning to original size and shape after deformation.

#### RMS and Ra

Root Mean Square - The measure of surface roughness, obtained as the square root of the sum of the squares of micro-inch deviation from true flat. 1 RMS micro-inch = 0,025  $\mu$ RA micro-meter.

#### Rough Trim

Removal of superfluous parts by pulling or picking. Usually a small portion of the flash or sprue remains attached to the product.

#### Rubber, Chloroprene

Homopolymer of chloroprene.

#### Runout (Shaft)

Same as Gyration. When expressed in inches or mm alone or accompanied by abbreviation "TIR" (total indicator reading), it refers to twice the radial distance between shaft axis and axis of rotation.

#### Seal

Any device used to prevent the passage of a gas or liquid.

#### Service

Operating conditions to be met.

#### Shaft

Rotating member within cylinder; not in contact with the walls.

#### Shelf-aging

The change in a material's properties which occurs in storage with time.

#### Shield, EMI

Electrically conductive materials placed around a circuit, component or cable, to suppress the effect of electromagnetic field.

#### Shore A Hardness

See Hardness and Durometer.

#### Shrinkage

Decreased volume of unit caused by air drying after immersion in fluid.

#### Silicone fluids

Oils and greases based on silicones.

#### Silicone, Fluorosilicone

Semi-organic elastomer, containing silicone.

### 21. Glossary

#### Silicone free

O-rings which are produced with a silicone free mold lubricant.

#### Size, Actual

Actual dimensions of the O-ring, including tolerance limits.

#### Size, Nominal

Approximate size of O-ring in fractional dimensions.

#### Size number

Number assigned to indicate inside and cross section diameters of an O-ring. Sizes established in SAE standard AS 568 have been adopted by the military and industry.

#### Specific Gravity

The ratio of the weight of a given substance to the weight of an equal volume of water at a specified temperature.

#### Specimens

Product parts used for testing.

#### Sprue Marks

Marks left on the surface of a rubber part, usually elevated, after removal of the flash.

#### Squeeze

cross section diametrical compression of O-ring between bottom surface of the groove and surface of other mating metal part in the gland assembly.

#### Static

Stationary application such as a gasket.

#### Static Seal

Seal designed to work between parts having no relative motions.

#### Stress

Force per unit of original cross sectional area required to stretch a specimen to a stated elongation.

#### Stress Relaxation

This is the phenomenon exhibited by an elastomer under constant compression, whereby the opposing force exerted by the elastomer decreases with time.

#### Sun Checking

Surface cracks, checks or crazing caused by exposure to direct or indirect sunlight.

#### Swell

Increased volume of unit caused by immersion in a fluid.

#### Synthetic Rubber

Manufactured elastomers.

#### Tear Resistance

Strength of a compound as resistance to growth of a cut or nick when tension is applied to the cut specimen.

#### Temperature Range

Lowest temperature at which rubber remains flexible and highest temperature at which it will function.

#### Tensile Strength

Force in pounds per square inch or in kilograms per square centimeter required to cause the rupture of a specimen of a rubber material.

#### Terpolymer

A polymer consisting of at least three different monomers chemically combined.

#### Thermal Effects

Deterioration at higher temperatures.

#### Thermal Expansion

Expansion caused by increase in temperature. May be linear and volumetric.

#### Thiokol

A synthetic rubber of the polysulfide type.

#### Torque

The turning power of a shaft.

### 21. Glossary

#### Torr

Comes from the tube of Torricelli. The unit of pressure used in vacuum measurement. It is equal to 1/760 of a standard atmosphere, and for all practical purposes is equivalent to one millimeter of mercury (mm HG).

#### Trim

The process involving removal of mold flash.

#### Trim Cut

Damage to mold skin or finish by too close trimming.

#### TR-10

The warming up temperature at which a frozen O-ring regains 10% of its elasticity.

#### Under-Cure

Degree of cure less than optimum. May be evidenced by inferior physical properties.

#### Vacuum

Situation in a given space that is occupied by a gas at less than atmospheric pressure.

#### Vacuum Level

The term used to denote the degree of Rough, Medium, High, Hard, or Ultra Hard vacuum evidenced by its pressure in torr (mm HG).

#### Vamac

Dupont Performance Elastomers' name for Ethylene Acrylate.

#### Vapor Pressure

The maximum pressure exerted by a liquid (or solid) heated to a given temperature in a closed container.

#### Viscosity

A manifestation of internal friction opposed to mobility. The property of fluids and plastic solids by which they resist an instantaneous change of shape, i.e., resistance to flow.

#### Voids

The absence of material or an area devoid of materials where not intended.

#### Volume Change

Change in volume of a specimen which has been immersed in a designated fluid under specified condition of time and temperature. Expressed as a percentage of the original volume.

#### Volume Swell

Increase in physical size caused by the swelling action of a liquid.

#### Vulcanization

A thermo-setting involving the use of heat and pressure and which results in greatly increased strength and elasticity of rubber-like materials.

#### Vulcanizing Agent

A material which produces vulcanization of an elastomer.

#### Vulc-O-ring

An O-ring manufactured from O-ring cord by splicing and bonding or vulcanizing.

#### Width

Radial dimension. For packing rings or sets the term "packing space" is preferred.

#### Wiper ring

A ring employed to remove excess fluid, mud, etc., from a reciprocating member before it reaches the seal.

### 22. On-line tools - Conversion Tables

ERIKS offers different methods of interactive customer solutions. Free programmes are available on our website.

- O-Ring Design Calculator : Industry leading
- Rubber Profile Calculator : Industry leading
- O-Ring Weight Calculator : Industry leading
- 130 data sheets : Industry leading
- Comparison of plastics : Industry leading
- Unit Converter : Industry leading
- Chemical Resistance Guide : Industry leading
- Approvals / Certificats : Industry leading

**ERIKS** know-how makes the difference | O-Ring Weight Calculator

ERIKS Compound:

Inner Diameter (mm):

Cross Section Diameter (mm):

Calculate

Weight each (g)	0.136
Weight / 100 pcs. (g)	13.571
Weight / 1.000 pcs. (g)	135.707
Weight / 1.000 pcs. (kg)	0.136
Weight / 10.000 pcs. (kg)	1.357
Weight / 100.000 pcs. (kg)	13.571

Print

This information is, to the best of our knowledge, accurate and reliable to the date indicated. The above mentioned data have been obtained by tests we consider as reliable. We don't warrant that the same results can be obtained in other laboratories using different conditions by the preparation and evaluation of the samples. %

**DuPont Performance Elastomers**

**DuPont Performance Elastomers Chemical Resistance Guide**

Introduction to Elastomers

General Chemical Resistance Guide  
from The Los Angeles Rubber Group, Inc.

Products of DuPont Performance Elastomers

Welcome to the DuPont Performance Elastomers Chemical Resistance Guide. Please select one of the three options to the left.

**ERIKS** know-how makes the difference | below selector

Search by:

all fields are required

Min inner diameter (mm)  Max outer diameter (mm)

find show all print

Click one of the column headers to sort

#	number of ribs	Proj. length	Max. Length (mm)	Min. Length (mm)	Material strength	Conn. -D 1	Conn. -D 2	Smal. inner -D	Big. outer -D	Material	Drawing
1	2	10	8	3	0.3	3	6	4.5	7.6	42 CR 764	VE-248
2	2	13	10	4	0.5	3	9.5	7.8	13.5	42 CR 764	VE-518
3	8	80	85	20	1	4	8	12.5	24	42 CR 764	VE-249
4	3	35	35	5.5	0.5	4	10	10.5	22	42 CR 764	VE-1008
5	2	20	25	4	0.6	4	10	14	25	42 CR 764	VE-949
6	3	30	30	0	0.8	4.5	14.5	7	18	42 CR 764	VE-25
7	4	45	50	15	1	5	12	12	24	42 CR 764	VE-258
8	3	45	40	12	1	5	19.5	12	34	42 CR 764	VE-358
9	2	22	26	5	0.6	5	26	20	33.2	42 CR 764	VE-940

**ERIKS** Technical Data Sheet

**ERIKS** Technical Data Sheet

**ERIKS** Technical Data Sheet

-- selector op material naam --

Material	Density	...	...
Acrylonitril-butadien	1,18	1,44	1,42
Polyurethane	1,25	< 0,08	< 0,08
Fluoropolymer	2,0	< 0,1	< 0,1
...	...	...	...



22. On-line tools - Conversion Tables

Conversion Table Fahrenheit to Celsius

°C	X	°F	°C	X	°F	°C	X	°F	°C	X	°F	°C	X	°F	°C	X	°F
-273	-459,4		-17,2	1	33,8				32,8	91	195,8	260	500	932	538	1000	1832
-268	-450		-16,7	2	35,6				33,3	92	197,6	266	510	950	549	1020	1868
-262	-440		-16,1	3	37,4				33,9	93	199,4	271	520	968	560	1040	1904
-257	-430		-15,6	4	39,2	9,4	49	120,2	34,3	94	201,2	277	530	986	571	1060	1940
-251	-420		-15,0	5	41,0	10,0	50	122,0	35,0	95	203,0	282	540	1004	582	1080	1976
-246	-410		-14,4	6	42,8	10,6	51	123,8	35,6	96	204,8	288	550	1022	593	1100	2012
-240	-400		-13,9	7	44,6	11,1	52	125,6	36,1	97	206,6	293	560	1040	604	1120	2048
-234	-390		-13,3	8	46,4	11,7	53	127,4	36,7	98	208,4	299	570	1058	616	1140	2084
-229	-380		-12,8	9	48,2	12,2	54	129,2	37,2	99	210,2	304	580	1076	627	1160	2120
-223	-370		-12,2	10	50,0	12,8	55	131,0	37,8	100	212,0	310	590	1094	638	1180	2156
-218	-360		-11,7	11	51,8	13,3	56	132,8	43	110	230	316	600	1112	649	1200	2192
-212	-350		-11,1	12	53,6	13,9	57	134,6	49	120	248	321	610	1130	660	1220	2228
-207	-340		-10,6	13	55,4	14,4	58	136,4	54	130	266	327	620	1148	671	1240	2264
-201	-330		-10,0	14	57,2	15,0	59	138,2	60	140	284	332	630	1166	682	1260	2300
-196	-320		-9,4	15	59,0	15,6	60	140,0	66	150	302	338	640	1184	693	1280	2336
-190	-310		-8,9	16	60,8	16,1	61	141,8	71	160	320	343	650	1202	704	1300	2372
-184	-300		-8,3	17	62,6	16,7	62	143,6	77	170	338	349	660	1220	732	1350	2462
-179	-290		-7,8	18	64,4	17,2	63	145,4	82	180	356	354	670	1238	760	1400	2552
-173	-280		-7,2	19	66,2	17,8	64	147,2	88	190	374	360	680	1256	788	1450	2642
-169	-273	-459,4	-6,7	20	68,0	18,3	65	149,0	93	200	392	366	690	1274	816	1500	2732
-168	-270	-454	-6,1	21	69,8	18,9	66	150,8	99	210	410	371	700	1292	843	1550	2822
-162	-260	-436	-5,6	22	71,6	19,4	67	152,6	100	212	414	377	710	1310	871	1600	2912
-157	-250	-418	-5,0	23	73,4	20,0	68	154,4	104	220	428	382	720	1328	899	1650	3002
-151	-240	-400	-4,4	24	75,2	20,6	69	156,2	110	230	446	388	730	1346	927	1700	3092
-146	-230	-382	-3,9	25	77,0	21,1	70	158,0	116	240	464	393	740	1364	954	1750	3182
-140	-220	-364	-3,3	26	78,8	21,7	71	159,8	121	250	482	399	750	1382	982	1800	3272
-134	-210	-346	-2,8	27	80,6	22,2	72	161,6	127	260	500	404	760	1400	1010	1850	3362
-129	-200	-328	-2,2	28	82,4	22,8	73	163,4	132	270	518	410	770	1418	1038	1900	3452
-123	-190	-310	-1,7	29	84,2	23,3	74	165,2	138	280	536	416	780	1436	1066	1950	3542
-118	-180	-292	-1,1	30	86,0	23,9	75	167,0	143	290	554	421	790	1454	1093	2000	3632
-112	-170	-274	-0,6	31	87,8	24,4	76	168,8	149	300	572	427	800	1472	1121	2050	3722
-107	-160	-256	0,0	32	89,6	25,0	77	170,6	154	310	590	442	810	1490	1149	2100	3812
-101	-150	-238	0,6	33	91,4	25,6	78	172,4	160	320	608	438	820	1508	1177	2150	3902
-96	-140	-220	1,1	34	93,2	26,1	79	174,2	166	330	626	443	830	1526	1204	2200	3992
-90	-130	-202	1,7	35	95,0	26,7	80	176,0	171	340	644	449	840	1544	1232	2250	4082
-84	-120	-184	2,2	36	96,8	27,2	81	177,8	177	350	662	454	850	1562	1260	2300	4172
-79	-110	-166	2,8	37	98,6	27,8	82	179,6	182	360	680	460	860	1580	1288	2350	4262
-73	-100	-148	3,3	38	100,4	28,3	83	181,4	188	370	698	466	870	1598	1316	2400	4352
-68	-90	-130	3,9	39	102,2	28,9	84	183,2	193	380	716	471	880	1616	1343	2450	4442
-62	-80	-112	4,4	40	104,0	29,4	85	185,0	199	390	734	477	890	1634	1371	2500	4532
-57	-70	-94	5,0	41	105,8	30,0	86	186,8	204	400	752	482	900	1652	1399	2550	4622
-51	-60	-76	5,6	42	107,6	30,6	87	188,6	210	410	770	488	910	1670	1427	2600	4712
-46	-50	-58	6,1	43	109,4	31,1	88	190,4	216	420	788	493	920	1688	1454	2650	4802
-40	-40	-40	6,7	44	111,2	31,7	89	192,2	221	430	806	499	930	1706	1482	2700	4892
-34	-30	-22	7,2	45	113,0	32,2	90	194,0	227	440	824	504	940	1724	1510	2750	4982
-29	-20	-4	7,8	46	114,8				232	450	842	510	950	1742	1538	2800	5072
-23	-10	14	8,3	47	116,6				238	460	860	516	960	1760	1566	2850	5162
-17,8	0	32	8,9	48	118,4				243	470	878	521	970	1778	1693	2900	5252
									249	480	896	527	980	1796	1621	2950	5342
									254	490	914	532	990	1814	1649	3000	5432

By starting from column X you can find the converted values in Fahrenheit (to the right of it) and Celsius (to the left of it).  
 For instance: 100°C in the middle column X = 212°F in the right column; 212°F in the middle column X = 100°C in the left column.  
 32°F = 0° freezing point of water / 212°F = 100°C boiling point of water / 68°F = 20°C room temperature / 98,6°F = 37°C body temperature.

22. On-line tools - Conversion Tables

Conversion Table psi to bar

psi	bar	psi	bar	psi	bar	psi	bar
1	0,07	61	4,21	205	14,13	710	48,98
2	0,14	62	4,27	210	14,48	720	49,67
3	0,21	63	4,34	215	14,82	730	50,35
4	0,28	64	4,41	220	15,17	740	51,04
5	0,35	65	4,48	225	15,51	750	51,73
6	0,41	66	4,55	230	15,86	760	52,42
7	0,48	67	4,62	235	16,20	770	53,11
8	0,55	68	4,69	240	16,55	780	53,80
9	0,62	69	4,76	245	16,89	790	54,49
10	0,69	70	4,83	250	17,24	800	55,18
11	0,76	71	4,90	255	17,58	810	55,87
12	0,83	72	4,96	260	17,93	820	56,56
13	0,90	73	5,03	265	18,27	830	57,25
14	0,97	74	5,10	270	18,62	840	57,93
15	1,03	75	5,17	275	18,96	850	58,62
16	1,10	76	5,24	280	19,31	860	59,31
17	1,17	77	5,31	285	19,65	870	60,00
18	1,24	78	5,38	290	20,00	880	60,69
19	1,31	79	5,45	295	20,34	890	61,38
20	1,38	80	5,52	300	20,69	900	62,07
21	1,45	81	5,58	310	21,38	910	62,76
22	1,52	82	5,65	320	22,07	920	63,45
23	1,59	83	5,72	330	22,76	930	64,13
24	1,65	84	5,79	340	23,45	940	64,82
25	1,72	85	5,86	350	24,14	950	65,51
26	1,79	86	5,93	360	24,83	960	66,20
27	1,86	87	6,00	370	25,52	970	66,89
28	1,93	88	6,07	380	26,21	980	67,58
29	2,00	89	6,14	390	26,90	990	68,27
30	2,07	90	6,21	400	27,59	1000	68,96
31	2,14	91	6,27	410	28,28	1010	69,95
32	2,21	92	6,34	420	28,97	1020	70,34
33	2,28	93	6,41	430	29,66	1030	71,03
34	2,34	94	6,48	440	30,35	1040	71,72
35	2,41	95	6,55	450	31,04	1050	72,41
36	2,48	96	6,62	460	31,73	1060	73,10
37	2,55	97	6,69	470	32,42	1070	73,79
38	2,62	98	6,76	480	33,11	1080	74,48
39	2,69	99	6,83	490	33,80	1090	75,17
40	2,76	100	6,89	500	34,49	1100	75,86
41	2,83	101	7,24	510	35,18	1120	77,24
42	2,90	110	7,58	520	35,87	1140	78,62
43	2,96	115	7,93	530	36,56	1160	80,00
44	3,03	120	8,27	540	37,25	1180	81,37
45	3,10	125	8,62	550	37,94	1200	82,74
46	3,17	130	8,96	560	38,63	1220	84,12
47	3,24	135	9,31	570	39,32	1240	85,50
48	3,31	140	9,65	580	40,01	1260	86,88
49	3,38	145	10,00	590	40,70	1280	88,26
50	3,45	150	10,34	600	41,39	1300	89,64
51	3,52	155	10,68	610	42,08	1320	91,02
52	3,59	160	11,03	620	42,77	1340	92,40
53	3,65	165	11,37	630	43,46	1360	93,78
54	3,72	170	11,72	640	44,15	1380	95,16
55	3,79	175	12,06	650	44,84	1400	96,54
56	3,86	180	12,41	660	45,53	1420	97,92
57	3,93	185	12,75	670	46,22	1440	99,30
58	4,00	190	13,10	680	46,91	1460	100,67
59	4,07	195	13,44	690	47,60	1480	102,05
60	4,14	200	13,79	700	48,29	1500	103,43

**22. On-line tools - Conversion Tables**

**Conversion Table inch to mm**

inch	0	1/16	1/8	3/16	1/4	5/16	3/8	7/16	1/2	9/16	5/8	11/16	3/4	13/16	7/8	15/16
0	0,0	1,6	3,2	4,8	6,4	7,9	9,5	11,1	12,7	14,3	15,9	17,5	19,1	20,6	22,2	23,8
1	25,4	27,0	28,6	30,2	31,8	33,3	34,9	36,5	38,1	39,7	41,3	42,9	44,5	46,0	47,6	49,2
2	50,8	52,4	54,0	55,6	57,2	58,7	60,3	61,9	63,5	65,1	66,7	68,3	69,9	71,4	73,0	74,6
3	76,2	77,8	79,4	81,0	82,6	84,1	85,7	87,3	88,9	90,5	92,1	93,7	95,3	96,8	98,4	100,0
4	101,6	103,2	104,8	106,4	108,0	109,5	111,1	112,7	114,3	115,9	117,5	119,1	120,7	122,2	123,8	125,4
5	127,0	128,6	130,2	131,8	133,4	134,9	136,5	138,1	139,7	141,3	142,9	144,5	146,1	147,6	149,2	150,8
6	152,4	154,0	155,6	157,2	158,8	160,3	161,9	163,5	165,1	166,7	168,3	169,9	171,5	173,0	174,6	176,2
7	177,8	179,4	181,0	182,6	184,2	185,7	187,3	188,9	190,5	192,1	193,7	195,3	196,9	198,4	200,0	201,6
8	203,2	204,8	206,4	208,0	209,6	211,1	212,7	214,3	215,9	217,5	219,1	220,7	222,3	223,8	225,4	227,0
9	228,6	230,2	231,8	233,4	235,0	236,5	238,1	239,7	241,3	242,9	244,5	246,1	247,7	249,2	250,8	252,4
10	254,0	255,6	257,2	258,8	260,4	261,9	263,5	265,1	266,7	268,3	269,9	271,5	273,1	274,6	276,2	277,8
11	279,4	281,0	282,6	284,2	285,8	287,3	288,9	290,5	292,1	293,7	295,3	296,9	298,9	300,0	301,6	303,2
12	304,8	306,4	308,0	309,6	311,2	312,7	314,3	315,9	317,5	319,1	320,7	322,3	323,9	325,4	327,0	328,6
13	330,2	331,8	333,4	335,0	336,6	338,1	339,7	341,3	342,9	344,5	346,1	347,7	349,3	350,8	352,4	354,0
14	355,6	357,2	358,8	360,4	362,0	363,5	365,1	366,7	368,3	369,9	371,5	373,1	374,7	376,2	377,8	379,4
15	381,0	382,6	384,2	385,8	387,4	388,9	390,5	392,1	393,7	395,3	396,9	398,5	400,1	401,6	403,2	404,8
16	406,4	408,0	409,6	411,2	412,8	414,3	415,9	417,5	419,1	420,7	422,3	423,9	425,5	427,0	428,6	430,2
17	431,8	433,4	435,0	436,6	438,2	439,7	441,3	442,9	444,5	446,1	447,7	449,3	450,9	452,4	454,0	455,6
18	457,2	458,8	460,4	462,0	463,6	465,1	466,7	468,3	469,9	471,5	473,1	474,7	476,3	477,8	479,4	481,0
19	482,6	184,2	485,8	487,4	489,0	490,5	492,1	493,7	495,3	496,9	498,5	500,1	501,7	503,2	504,8	506,4
20	508,0	509,6	511,2	512,8	514,4	515,9	517,5	519,1	520,7	522,3	523,9	525,5	527,1	528,6	530,2	531,8
21	533,4	535,0	536,6	538,2	539,8	541,3	542,9	544,5	546,1	547,7	549,3	550,9	552,5	554,0	555,6	557,2
22	558,8	560,4	562,0	563,6	565,2	566,7	568,3	569,9	571,5	573,1	574,7	576,3	577,9	579,4	581,0	582,6
23	584,2	585,8	587,4	589,0	590,6	592,1	593,7	595,3	596,9	598,5	600,1	601,7	603,3	604,8	606,4	608,0
24	609,6	611,2	612,8	614,4	616,0	617,5	619,1	620,7	622,3	623,9	625,5	627,1	628,7	630,2	631,8	633,4
25	635,0	636,6	638,2	639,8	641,4	642,9	644,5	646,1	647,7	649,3	650,9	652,5	654,1	655,6	657,2	658,8
26	660,4	662,0	663,6	665,2	666,8	668,3	669,9	671,5	673,1	674,7	676,3	677,9	679,5	681,0	682,6	684,2
27	685,8	687,4	689,0	690,6	692,2	693,7	695,3	696,9	698,5	700,1	701,7	703,3	704,9	706,4	708,0	709,6
28	711,2	712,8	714,4	716,0	717,6	719,1	720,7	722,3	723,9	725,5	727,1	728,7	730,3	731,8	733,4	735,0
29	736,6	738,2	439,8	741,4	743,0	744,5	746,1	747,7	749,3	750,9	752,5	754,1	755,7	757,2	758,8	760,4
30	762,0	763,6	765,2	766,8	768,4	769,9	771,5	773,1	774,7	776,3	777,9	779,5	781,1	782,6	784,2	785,8
31	787,4	789,0	790,6	792,2	783,8	795,3	796,9	798,5	800,1	801,7	803,3	804,9	806,5	808,0	809,6	811,2
32	812,8	814,4	816,0	817,6	819,2	820,7	822,3	823,9	825,5	827,1	828,7	830,3	831,9	833,4	835,0	836,6
33	838,2	839,8	841,4	843,0	844,6	846,1	847,7	849,3	850,9	852,5	854,1	855,7	857,3	858,8	860,4	862,0
34	863,6	865,2	866,8	868,4	870,0	871,5	873,1	874,7	876,3	877,9	879,5	881,1	882,7	884,2	885,8	887,4
35	889,0	890,6	892,2	893,8	895,4	896,9	898,5	900,1	901,7	903,3	904,9	906,5	908,1	909,6	911,2	912,8
36	914,4	916,0	917,6	919,2	920,8	922,3	923,9	925,5	927,1	928,7	930,3	931,9	933,5	935,0	936,6	938,2
37	939,8	841,4	943,0	944,6	946,2	947,7	949,7	950,9	952,5	954,1	955,7	957,3	958,9	960,4	962,0	963,6
38	965,2	966,8	968,4	970,0	971,6	973,1	974,7	976,3	977,9	979,5	981,1	982,7	984,3	985,8	987,4	989,0
39	990,6	992,2	993,8	995,4	997,0	998,5	1000,1	1001,7	1003,3	1004,9	1006,5	1008,1	1009,7	1011,2	1012,8	1014,4
40	1016,0	1017,6	1019,2	1020,8	1022,4	1023,9	1025,5	1027,1	1028,7	1030,3	1031,9	1033,5	1035,1	1036,6	1038,2	1039,8
41	1041,4	1043,0	1044,6	1046,2	1047,8	1049,3	1050,9	1052,5	1054,1	1055,7	1057,3	1058,9	1060,5	1062,0	1063,6	1065,2
42	1066,8	1068,4	1070,0	1071,6	1073,2	1074,7	1076,3	1077,9	1079,5	1081,1	1082,7	1084,3	1085,9	1087,4	1089,0	1090,6
43	1092,2	1093,8	1095,4	1097,0	1098,6	1100,1	1101,7	1103,3	1104,9	1106,5	1108,1	1109,7	1111,3	1112,8	1114,4	1116,0
44	1117,6	1119,2	1120,8	1122,4	1124,0	1125,5	1127,1	1128,7	1130,3	1131,9	1133,5	1135,1	1136,7	1138,2	1139,8	1141,4
45	1143,0	1144,6	1146,2	1147,8	1149,4	1150,9	1152,5	1154,1	1155,7	1157,3	1158,9	1160,5	1162,1	1163,6	1165,2	1166,8
46	1168,4	1170,0	1171,6	1173,2	1174,8	1176,3	1177,9	1179,5	1181,1	1182,7	1184,3	1185,9	1187,5	1189,0	1190,6	1192,2
47	1193,8	1195,4	1197,0	1198,6	1200,2	1201,7	1203,3	1204,9	1206,5	1208,1	1209,7	1211,3	1212,9	1214,4	1216,0	1217,6
48	1219,2	1220,8	1222,4	1224,0	1225,6	1227,1	1228,7	1230,3	1231,9	1233,5	1235,1	1236,7	1238,3	1239,8	1241,4	1243,0
49	1244,6	1246,2	1247,8	1249,4	1251,0	1252,5	1254,1	1255,7	1257,3	1258,9	1260,5	1262,1	1263,7	1265,2	1266,8	1268,4
50	1270,0	1271,6	1273,2	1274,8	1276,4	1277,9	1279,5	1281,1	1282,7	1284,3	1285,9	1287,5	1289,1	1290,6	1292,2	1293,8

### 22. On-line tools - Conversion Tables

Length				
Millimeter	Meter	Inch (in)	Foot (ft)	Yard (yd)
1	0.001	.394	.0033	.0011
1000	1	39.3701	3.2808	1.0936
25.4	0.254	1	0.0833	0.0278
304.8	0.3048	12	1	0.3333
914.4	0.9144	36	3	1

Capacity						
m <sup>3</sup>	cm <sup>3</sup>	Liter	Cubic inch (in <sup>3</sup> )	Cubic foot (ft <sup>3</sup> )	UK gallon	US gallon
1	1000000	999.972	61023.7	35.3147	219.969	264.172
0.000001	1	0.0009997	0.061	0.0000353	0.00022	0.0026
0.001	1000.028	1	61.0255	0.0353	0.22	0.2642
0.000016	16.3871	0.0164	1	0.00058	0.0036	0.0043
0.0283	28316.8	28.3161	1728	1	6.2288	7.4805
0.0045	4546.09	4.546	277.419	0.1605	1	1.201
0.0038	3785.41	3.7853	231	0.1337	0.8327	1

Speed				
Meter per second m/s	Foot per second ft/s	Foot per minute ft/m	Km per hour km/h	Mile per hour mile/h
1	3.2808	196.85	3.6	2.2368
0.3048	1	60	1.0973	0.6818
18.288	0.0167	1	65.8368	40.9091
0.2776	0.9113	54.68	1	0.6214
0.447	1.4665	87.99	1.6093	1

Capacity					
Kilogram kgf	Pound lb	Hundredweight cwt	Metric Ton	UK Ton	US short ton sh ton
1	2.2046	0.0197	0.001	0.00098	0.0011
0.4536	1	0.0089	0.000454	0.000446	0.0005
50.8023	112	1	0.0508	0.05	0.056
1000	2204.62	19.6841	1	0.9842	1.1023
1016.05	2240	20	1.0161	1	1.12
907.185	2000	17.8571	0.9072	0.8929	1

Speed				
Kg per second kg/s	Kg per hour kg/h	Pound per hour lb/h	Ton per hour UK ton/h	Eur. ton per day t/d
1	3600	7936.64	3.54314	86.4
0.000278	1	2.2046	0.000984	0.024
0.000126	0.4536	1	0.000446	0.0109
0.2822	1016.05	2240	1	24.3852
0.0116	41.6667	91.8592	0.04101	1

Pound (lb = 16 ounce)  
Ounce = 28,35 gram  
Grain (1/7000 lb) = 0.0648 gram

## 23.A. Approvals and Acknowledgements

### Trade names :

#### Viton®

Viton® is a registered trademark of DuPont Performance Elastomers.  
 ERIKS is officially licensed by DuPont Performance Elastomers to use the genuine Viton® trademark.



#### Teflon®

Teflon® is the trademark of DuPont Company. Teflon® is the family name for DuPont's range of fluoropolymers such as FEP, PFA, and Tefzel. ERIKS is officially licensed by DuPont company to use the Genuine Teflon® trademark.



#### Kalrez®

Kalrez® is a registered trademark of DuPont Performance Elastomers. ERIKS is officially licensed by DuPont Performance Elastomers to use the Kalrez® trademark.



### Homologations :



Ask for our 'Technical books' on:  
 High purity and FDA seals  
 Viton® and Kalrez®

### 23.B. Applications and Markets

#### Ready for high-demanding markets

ERIKS operates in an environment of continuous improvement, supported by extensive investment in facilities which promote continuous efficiency improvements. ERIKS develops every year new compounds and designs to satisfy the most demanding requirements of our customers. Due to this innovative approach ERIKS delivers many OEM's worldwide in different sectors:

- nuclear
- oil and gas
- life science
- semiconductor
- potable water
- food and dairy
- CPI
- 'green' energy
- electronics
- automotive

ERIKS has experience in different fields in the industry. Our dedicated material, market and engineering specialists are your partner for individual solutions.

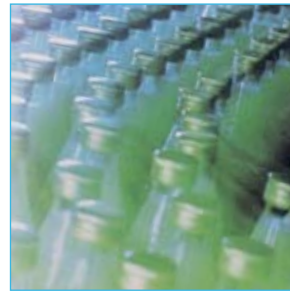

### 24. ERIKS' Global Distribution Network & Technical Support

#### Global distribution Network

ERIKS has a broad global distribution network of seal specialists. They can provide technical and application assistance in addition to a wide product offering.

#### Technical support

ERIKS chemists and engineers are ready to provide our customers with excellent technical and applications support. Seal design assistance, failure analysis, quality certifications, application testing and custom seal design are but a few of the services that are available.

#### ERIKS welcomes your comments!

We at ERIKS are constantly striving to improve our products and services. We want to make doing business with us easy, fast, efficient, and enjoyable.

One of the most important aspects of a relationship is communication. Our relationship with you is very important to us.



